



SOLISTRAND

TE Internal #: 132066-2

Closed Ring Tongue Terminal, 1/0 AWG, 5/16 / M8 Stud, 8.33 mm [.328 in] Stud Diameter, Closed Barrel, Straight, Nickel Plating, Uninsulated

[View on TE.com >](#)

Terminals & Splices > Ring Terminals

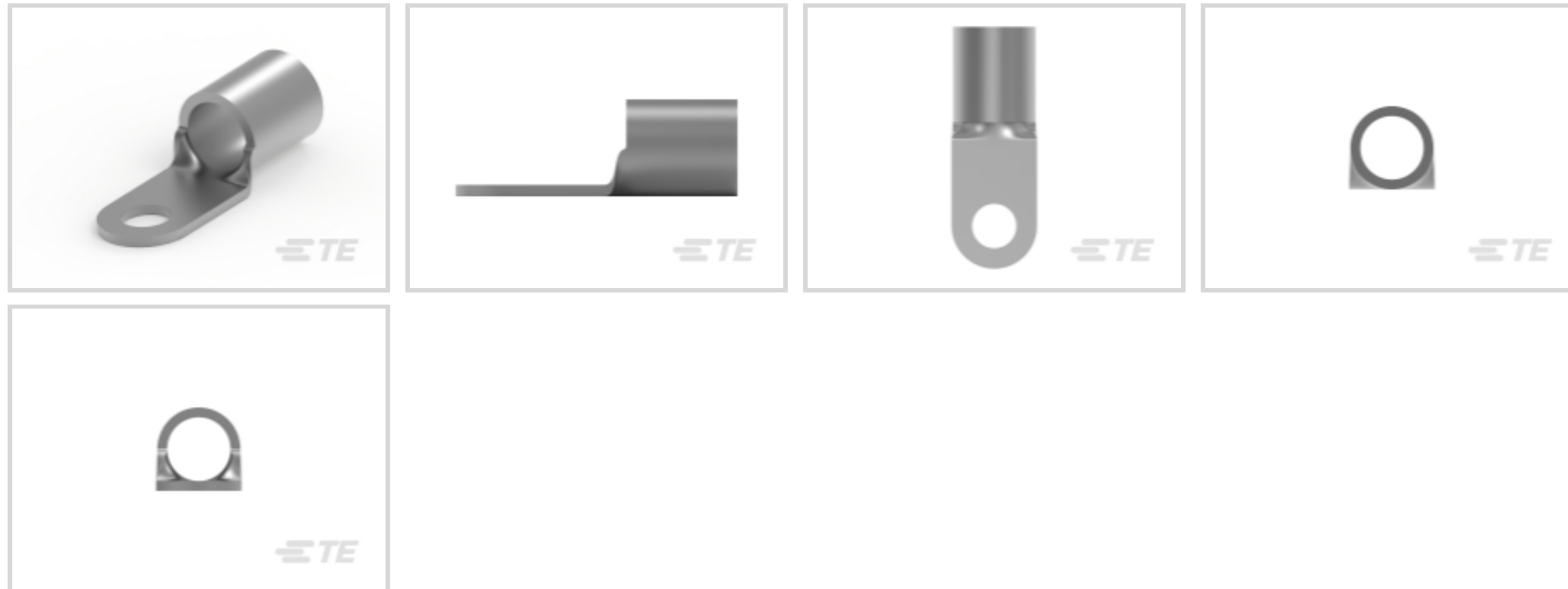

Ring Terminal Product Type: Closed Ring Tongue Terminal

Wire Size: 98676 – 118412 CMA

Stud Size: M8, 5/16

Features

Configuration Features

Number of Holes	1
-----------------	---

Body Features

Product Weight	17.99 g
----------------	---------

Mechanical Attachment

Wire Insulation Support	Without
-------------------------	---------

Industry Standards

Government Qualified Terminal	No
-------------------------------	----

Packaging Features

Packaging Quantity	50
Packaging Method	Loose Piece

Product Type Features

Ring Terminal Product Type	Closed Ring Tongue Terminal
Stud Size	M8, 5/16
Sealable	No
Wire Insulation Support Retention Type	Insulation Support



### Contact Features

Barrel Type	Closed
Terminal Orientation	Straight
Terminal Plating Material	Nickel

### Dimensions

Wire Size	98676 – 118412 CMA
Stud Diameter	8.33 mm [.328 in]
Tongue Thickness	.79 mm [.031 in]
Product Length	45.47 mm [1.79 in]
Barrel Inside Diameter	11.28 mm [.444 in]

### Usage Conditions

Insulation Option	Uninsulated
-------------------	-------------

### Operation/Application

Compatible With Wire Base Material	Nickel
Compatible With Wire Plating Material	Nickel

### Other

EU RoHS Compliance	Compliant
EU ELV Compliance	Compliant

### Product Compliance

[For compliance documentation, visit the product page on TE.com>](#)

EU RoHS Directive 2011/65/EU	Compliant
EU ELV Directive 2000/53/EC	Compliant
China RoHS 2 Directive MIIT Order No 32, 2016	No Restricted Materials Above Threshold
EU REACH Regulation (EC) No. 1907/2006	Current ECHA Candidate List: JUNE 2024 (241) Candidate List Declared Against: JUNE 2024 (241) Does not contain REACH SVHC
Halogen Content	Low Halogen - Br, Cl, F, I < 900 ppm per homogenous material. Also BFR/CFR/PVC Free
Solder Process Capability	Not applicable for solder process capability

Product Compliance Disclaimer

This information is provided based on reasonable inquiry of our suppliers and represents our current actual knowledge based on the information they provided. This information is subject to change. The part numbers that TE has identified as EU RoHS compliant have a maximum concentration of 0.1% by weight in homogenous materials for lead, hexavalent chromium, mercury, PBB, PBDE, DBP, BBP, DEHP, DIBP, and 0.01% for cadmium, or qualify for an exemption to these limits as defined in the Annexes of Directive 2011/65/EU (RoHS2). Finished electrical and electronic equipment products will be CE marked as required by Directive 2011/65/EU. Components may not be CE marked. Additionally, the part numbers that TE has identified as EU ELV compliant have a maximum concentration of 0.1% by weight in homogenous materials for lead, hexavalent chromium, and mercury, and 0.01% for cadmium, or qualify for an exemption to these limits as defined in the Annexes of Directive 2000/53/EC (ELV). Regarding the REACH Regulation, the information TE provides on SVHC in articles for this part number is based on the latest European Chemicals Agency (ECHA) 'Guidance on requirements for substances in articles' posted at this URL: <https://echa.europa.eu/guidance-documents/guidance-on-reach>

## Compatible Parts

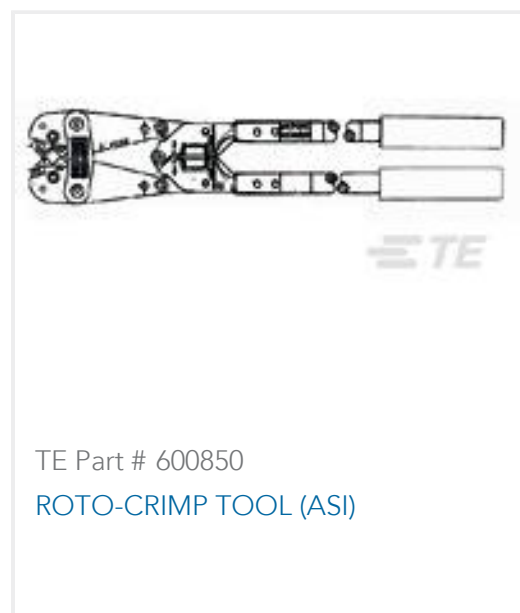
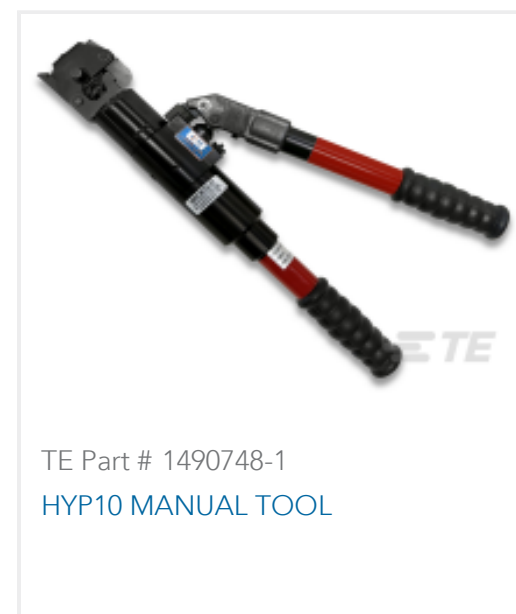

## Customers Also Bought

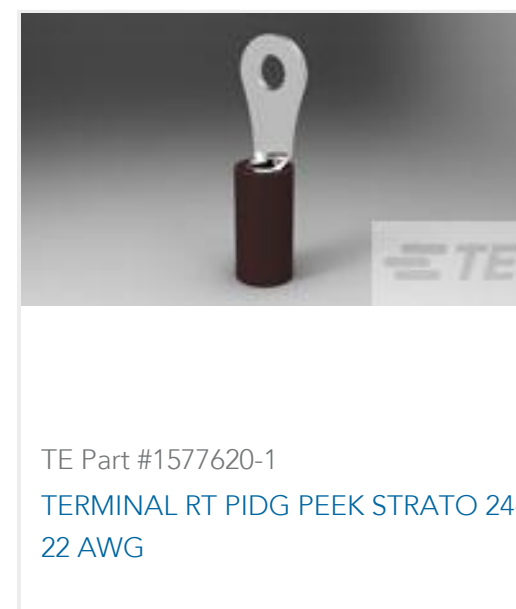
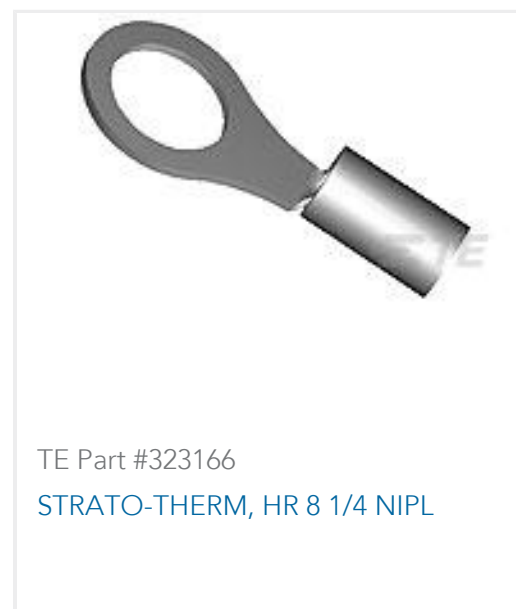

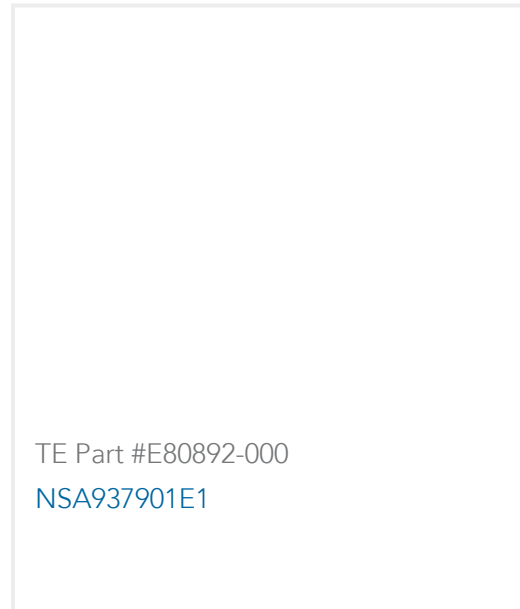
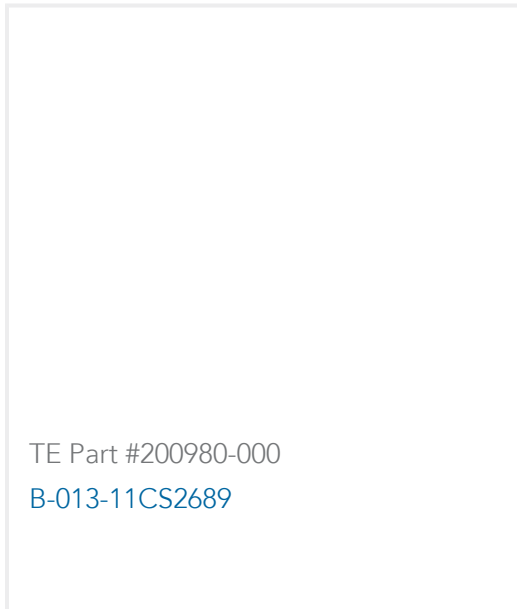

## Documents

### Product Drawings

#### TERMINAL SOLISTRAND RING HR 1/0

English

### CAD Files

#### 3D PDF

3D

#### Customer View Model

[ENG\\_CVM\\_CVM\\_132066-2\\_E.2d\\_dxf.zip](#)

English

#### Customer View Model

[ENG\\_CVM\\_CVM\\_132066-2\\_E.3d\\_igs.zip](#)

English

#### Customer View Model

[ENG\\_CVM\\_CVM\\_132066-2\\_E.3d\\_stp.zip](#)

English

By downloading the CAD file I accept and agree to the [Terms and Conditions](#) of use.