



AMP | Multilock Connector System

TE Internal #: 1123043-2

TE Internal Description: 040 III HD 72POS CAP ASSY H TIN

High Pin Count Header

[View on TE.com >](#)

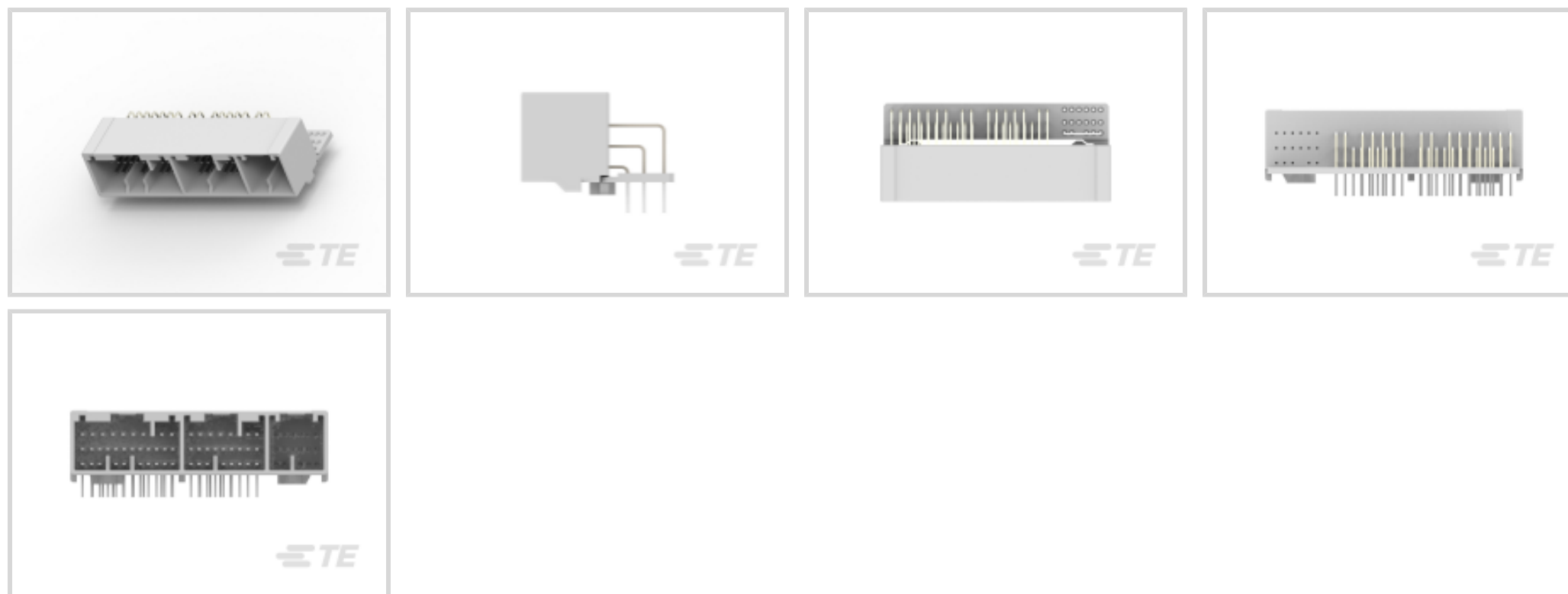

All High Pin Count Header (44)

Product Compliance

[For compliance documentation, visit the product page on TE.com>](#)

EU RoHS Directive 2011/65/EU	Compliant
EU ELV Directive 2000/53/EC	Compliant
China RoHS 2 Directive MIIT Order No 32, 2016	No Restricted Materials Above Threshold
EU REACH Regulation (EC) No. 1907/2006	Current ECHA Candidate List: JUNE 2024 (241) Candidate List Declared Against: JUNE 2024 (241) Does not contain REACH SVHC
Halogen Content	Low Halogen - Br, Cl, F, I < 900 ppm per homogenous material. Also BFR/CFR/PVC Free
Solder Process Capability	Wave solder capable to 240°C

Product Compliance Disclaimer

This information is provided based on reasonable inquiry of our suppliers and represents our current actual knowledge based on the information they provided. This information is subject to change. The part numbers that TE has identified as EU RoHS compliant have a maximum concentration of 0.1% by weight in homogenous materials for lead, hexavalent chromium, mercury, PBB, PBDE, DBP, BBP, DEHP, DIBP, and 0.01% for cadmium, or qualify for an exemption to these limits as defined in the Annexes of Directive 2011/65/EU (RoHS2). Finished electrical and electronic equipment products will be CE marked as required by Directive 2011/65/EU. Components may not be CE marked. Additionally, the part numbers that TE has identified as EU ELV compliant have a maximum concentration of 0.1% by weight in homogenous materials for lead, hexavalent chromium, and mercury, and 0.01% for cadmium, or qualify for an exemption to these limits as defined in the Annexes of Directive 2000/53/EC (ELV). Regarding the REACH Regulation, the information TE provides on SVHC in articles for this part number is based on the latest European Chemicals Agency (ECHA) 'Guidance on requirements for substances in articles' posted at this URL: <https://echa.europa.eu/guidance-documents/guidance-on-reach>

## Compatible Parts



## Also in the Series | Multilock Connector System

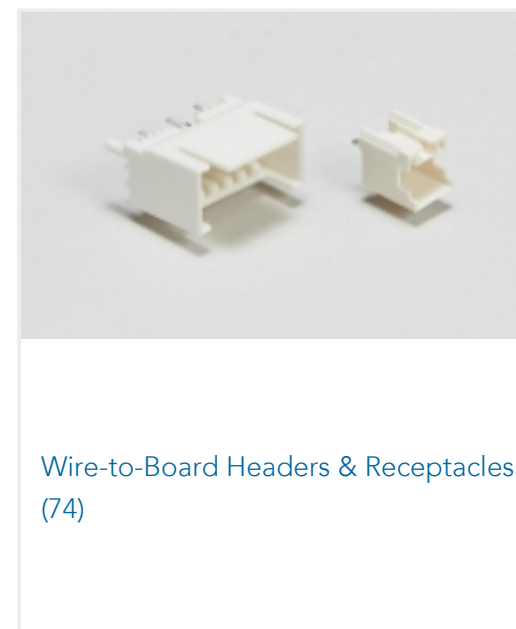
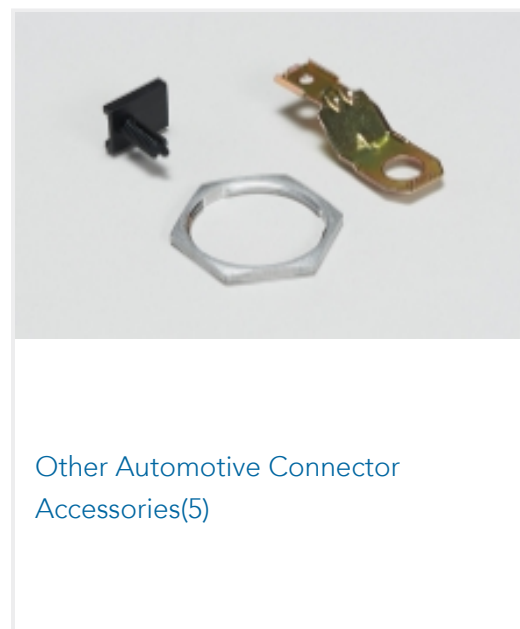
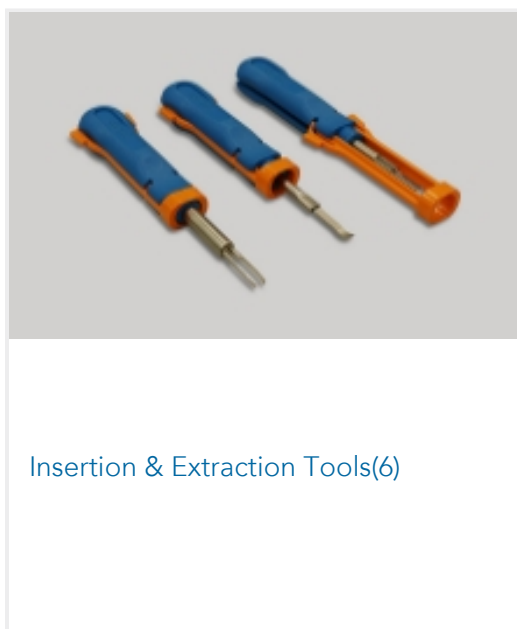
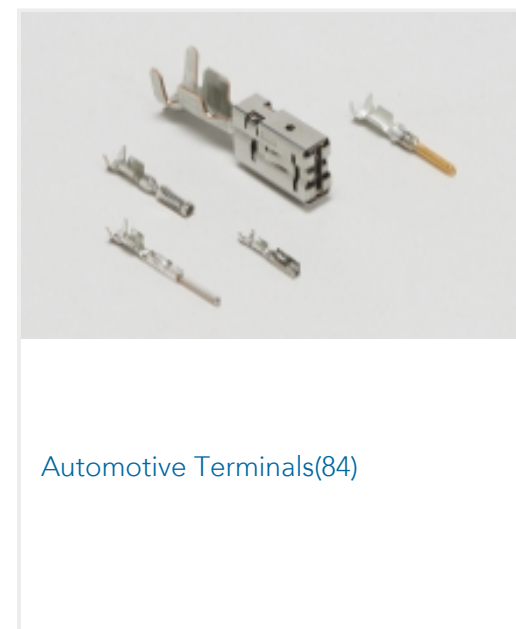
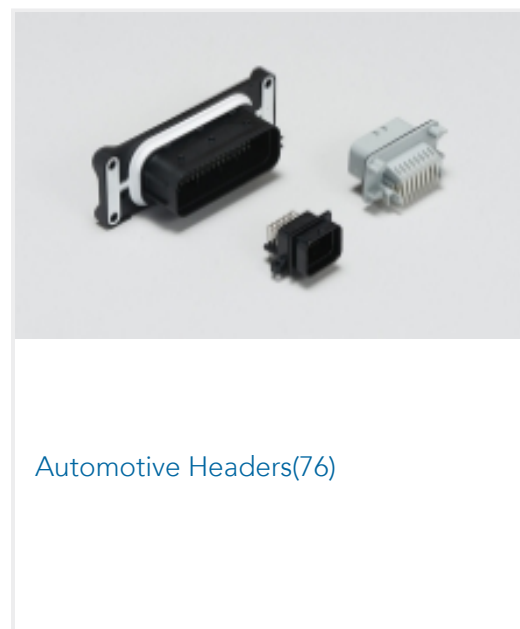

## Customers Also Bought

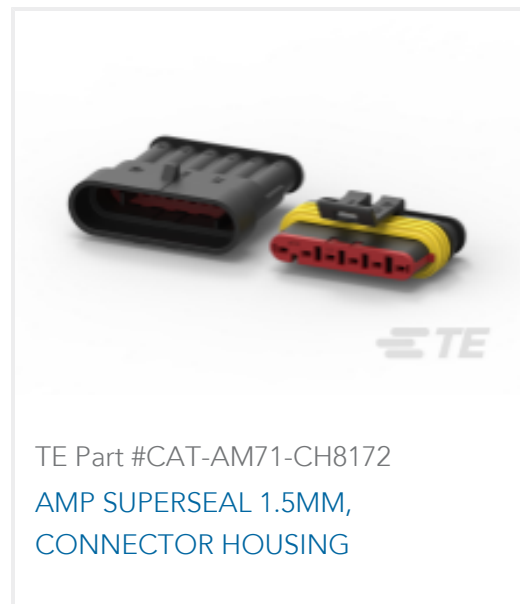

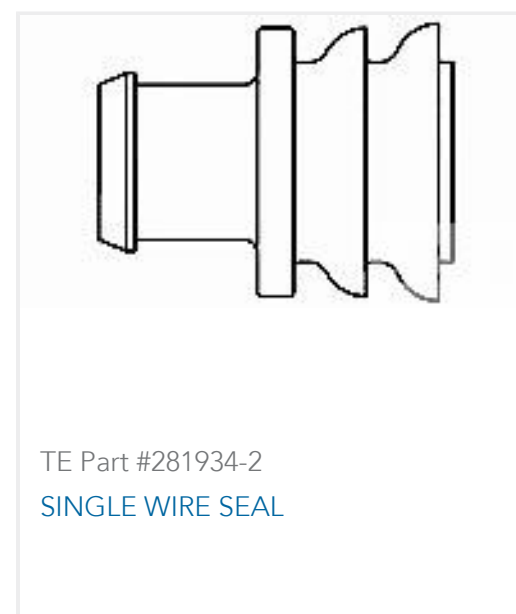
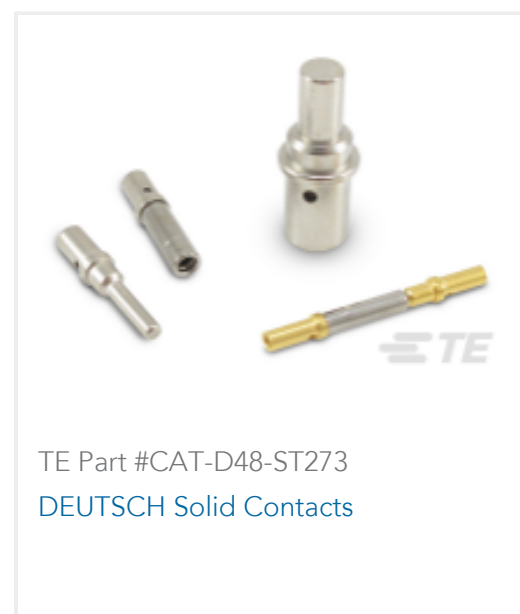

## Documents

### Product Drawings

040 III HD 72POS CAP ASSY H TIN

Japanese

040 III HD 72POS CAP ASSY H TIN

English

### CAD Files

3D PDF

3D

Customer View Model

ENG\_CVM\_CVM\_1123043-2\_F.2d\_dxf.zip

English

Customer View Model

ENG\_CVM\_CVM\_1123043-2\_F.3d\_igs.zip

English

Customer View Model

ENG\_CVM\_CVM\_1123043-2\_F.3d\_stp.zip

English

By downloading the CAD file I accept and agree to the [Terms and Conditions](#) of use.

### Product Specifications

Product Specification

Japanese

040 III High Density Connector

Japanese

Product Specification

Japanese

040 III High Density Connector

Japanese