

1-926657-5 ✓ ACTIVE

AMPMODU | AMPMODU LOCKING CLIP

TE Internal #: 1-926657-5

15 Position, Receptacle, Housing, Crimp, Wire-to-Board, UL 94V-0,
2.54 mm [.1 in] Centerline, 1 Row, Wire & Cable, Signal,
AMPMODU LOCKING CLIP

[View on TE.com >](#)



Connectors > Rectangular Connectors > Standard Rectangular Connectors



Connector Product Type: **Housing**

Connector & Housing Type: **Receptacle**

Connector System: **Wire-to-Board**

UL Flammability Rating: **UL 94V-0**

Number of Positions: **15**

Features

Product Type Features

Connector Product Type	Housing
Connector & Housing Type	Receptacle
Connector System	Wire-to-Board
Connector & Contact Terminates To	Wire & Cable

Configuration Features

Number of Positions	15
Number of Rows	1

Body Features

Primary Product Color	Black
-----------------------	-------

Contact Features

Contact Type	Socket
Contact Current Rating (Max)	3 A

Termination Features

Termination Method to Wire & Cable	Crimp
------------------------------------	-------

Mechanical Attachment

Strain Relief	Without
Mating Retention	Without
Connector Mounting Type	Cable Mount (Free-Hanging)



Housing Features

Housing Entry Configuration	Both Ends Closed
Centerline (Pitch)	2.54 mm [.1 in]
Housing Material	PBT GV15

Dimensions

Row-to-Row Spacing	2.54 mm [.1 in]
--------------------	-----------------

Usage Conditions

Operating Temperature Range	-65 – 105 °C [-85 – 221 °F]
-----------------------------	-----------------------------

Operation/Application

Circuit Application	Signal
---------------------	--------

Industry Standards

UL Flammability Rating	UL 94V-0
------------------------	----------

Packaging Features

Packaging Method	Carton
Packaging Quantity	1000

Product Compliance

[For compliance documentation, visit the product page on TE.com>](#)

EU RoHS Directive 2011/65/EU	Compliant
EU ELV Directive 2000/53/EC	Compliant
China RoHS 2 Directive MIIT Order No 32, 2016	有害物质含量符合标准要求 No Restricted Substance(s) Above Threshold
EU REACH Regulation (EC) No. 1907/2006	Current ECHA Candidate List: JUNE 2025 (250) Candidate List Declared Against: JUNE 2025 (250) Does not contain REACH SVHC
Halogen Content	Not Low Halogen - contains Br or Cl > 900 ppm.
Solder Process Capability	Not applicable for solder process capability

Product Compliance Disclaimer

This information is provided based on reasonable inquiry of our suppliers and represents our current actual knowledge based on the information they provided. This information is subject to change. The part numbers that TE has identified as EU RoHS compliant have a maximum concentration of 0.1% by weight in homogenous materials for lead, hexavalent chromium, mercury, PBB, PBDE, DBP, BBP, DEHP, DIBP, and 0.01% for cadmium, or qualify for an exemption to these

limits as defined in the Annexes of Directive 2011/65/EU (RoHS2). Finished electrical and electronic equipment products will be CE marked as required by Directive 2011/65/EU. Components may not be CE marked. Additionally, the part numbers that TE has identified as EU ELV compliant have a maximum concentration of 0.1% by weight in homogenous materials for lead, hexavalent chromium, and mercury, and 0.01% for cadmium, or qualify for an exemption to these limits as defined in the Annexes of Directive 2000/53/EC (ELV). Regarding the REACH Regulation, the information TE provides on SVHC in articles for this part number is based on the latest European Chemicals Agency (ECHA) 'Guidance on requirements for substances in articles' posted at this URL: <https://echa.europa.eu/guidance-documents/guidance-on-reach>

Compatible Parts

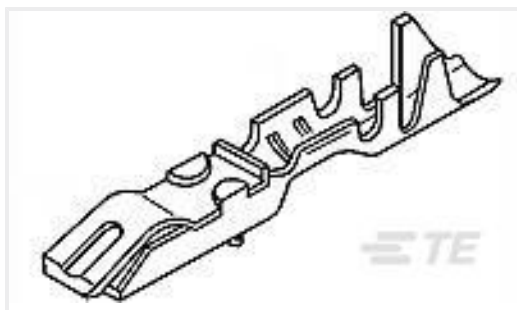

TE Part # 5-87165-2
LOCKING CLIP ASSY .025 SQ LP

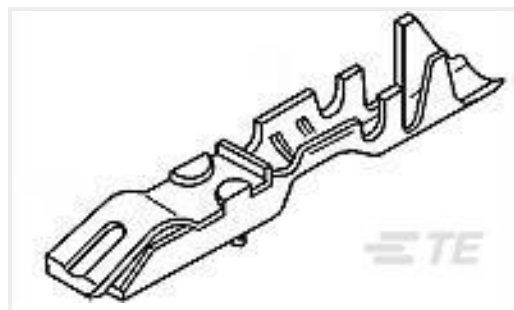

TE Part # 5-87191-2
LOCKING CLIP ASSY .025 SQ LP



TE Part # 5-87124-2
LOCKING CLIP CONT ASSY .025 SQ



TE Part # 87191-1
LOCKING CLIP ASSY .025 SQ LP

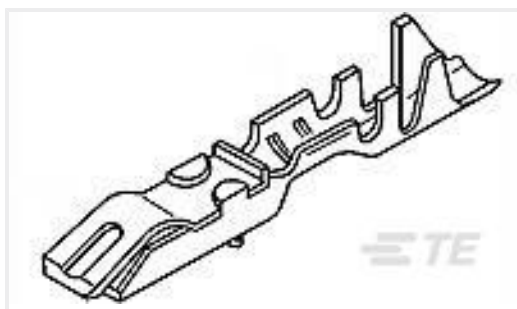

TE Part # 87165-1
LOCKING CLIP ASSY .025 SQ LP

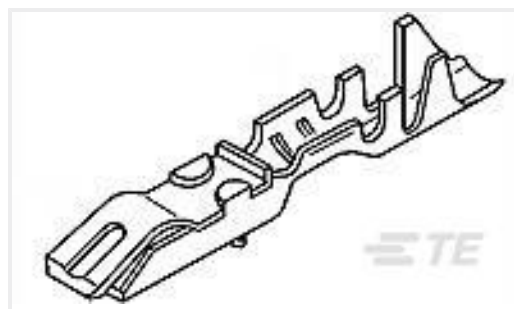

TE Part # 867052-1
LOCKING CLIP CONT ASSY .025 SQ

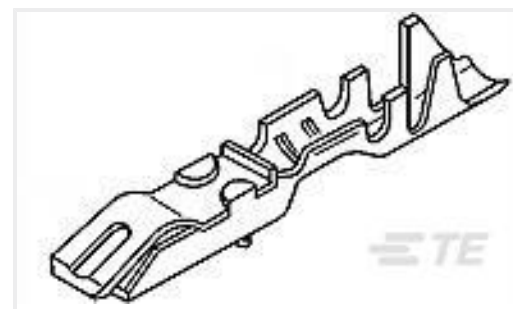

TE Part # 87165-2
LOCKING CLIP ASSY .025 SQ LP

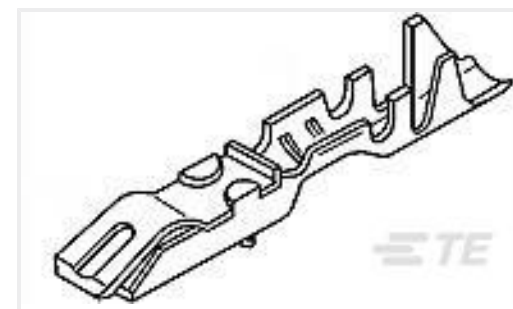

TE Part # 87190-1
LOCKING CLIP CONT ASSY .025 SQ

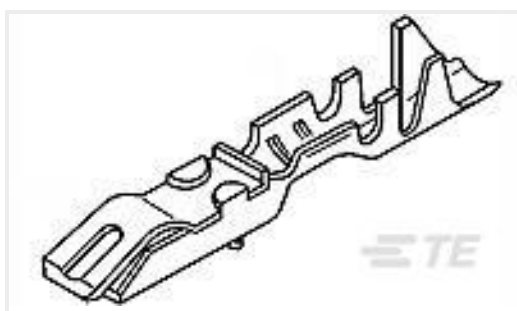

TE Part # 5-867052-1
LOCKING CLIP CONT ASSY .025 SQ



TE Part # 87124-1
LOCKING CLIP CONT ASSY .025 SQ



TE Part # 867052-2
LOCKING CLIP CONT ASSY .025 SQ

Also in the Series | AMPMODU LOCKING CLIP



Connector Contacts(5)



Connector Hardware(1)



Insertion & Extraction Tools(2)



Rectangular Connector Housings(53)



Rectangular Power Connectors(32)

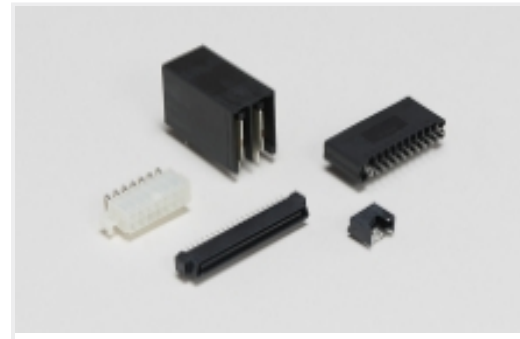

Standard Rectangular Connectors(53)

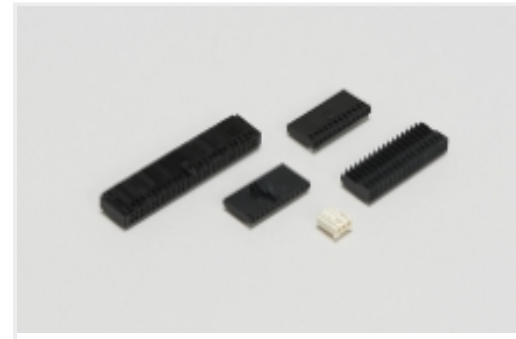

Wire-to-Board Connector Assemblies & Housings(53)

Customers Also Bought

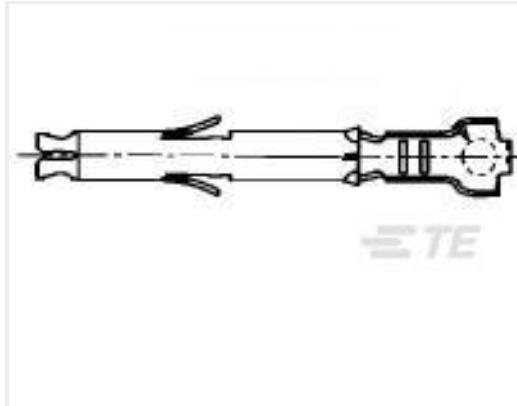

TE Part #170366-1
MINI UNIVERSAL M-N-L SOCKET LP



TE Part #172337-1
MINI UMNL PLUG HOUSING 3P



TE Part #172338-1
MINI UMNL PLUG HOUSING 4P



TE Part #794611-1
MICRO MNL RPT CNT,LS PC,TIN



TE Part #826648-2
2P AMPMODU II STIFT LEI

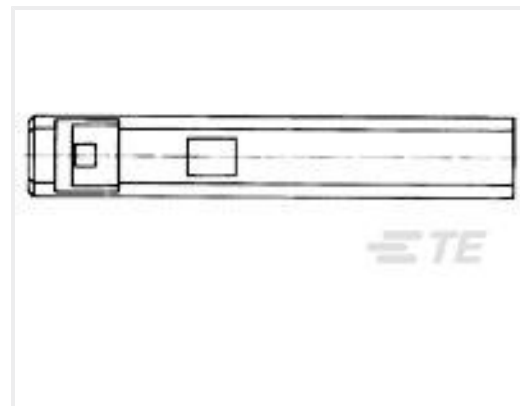

TE Part #926657-4
LOCKING CLIP HSG



TE Part #928205-2
2P TELFIX BU-GEH

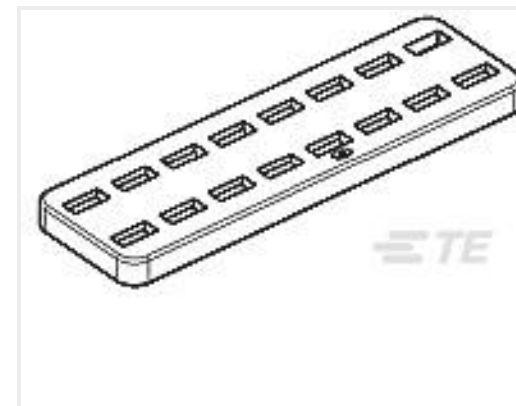

TE Part #963205-1
SEAL



TE Part #1445022-2
MICRO MNL RECEPT HSG SINGLE R



TE Part #1658612-4
09 POS HDF RCPT, MS, LEAD FREE

Documents

Product Drawings

[15P LOCKG CLIP GEH](#)

English

CAD Files

[Customer View Model](#)

[ENG_CVM_1-926657-5_E1.3d_igs.zip](#)

English

[Customer View Model](#)



[ENG_CVM_1-926657-5_E1.3d_stp.zip](#)

English

Customer View Model

[ENG_CVM_1-926657-5_E1.2d_dxf.zip](#)

English

3D PDF

English

By downloading the CAD file I accept and agree to the [Terms and Conditions](#) of use.

Agency Approvals

UL Report

English