

1-292254-0 ✓ ACTIVE



AMP CT

TE Internal #: 1-292254-0

Connector Assembly, Plug to Plug Relay Header, Wire-to-Panel, 10

Position, 2 mm [.078 in] Centerline, 1 Row, Natural, Signal, Panel

Mount, AMP CT

[View on TE.com >](#)

Connectors > PCB Connectors > Wire-to-Board Connectors > Wire-to-Board Connector Assemblies & Housings

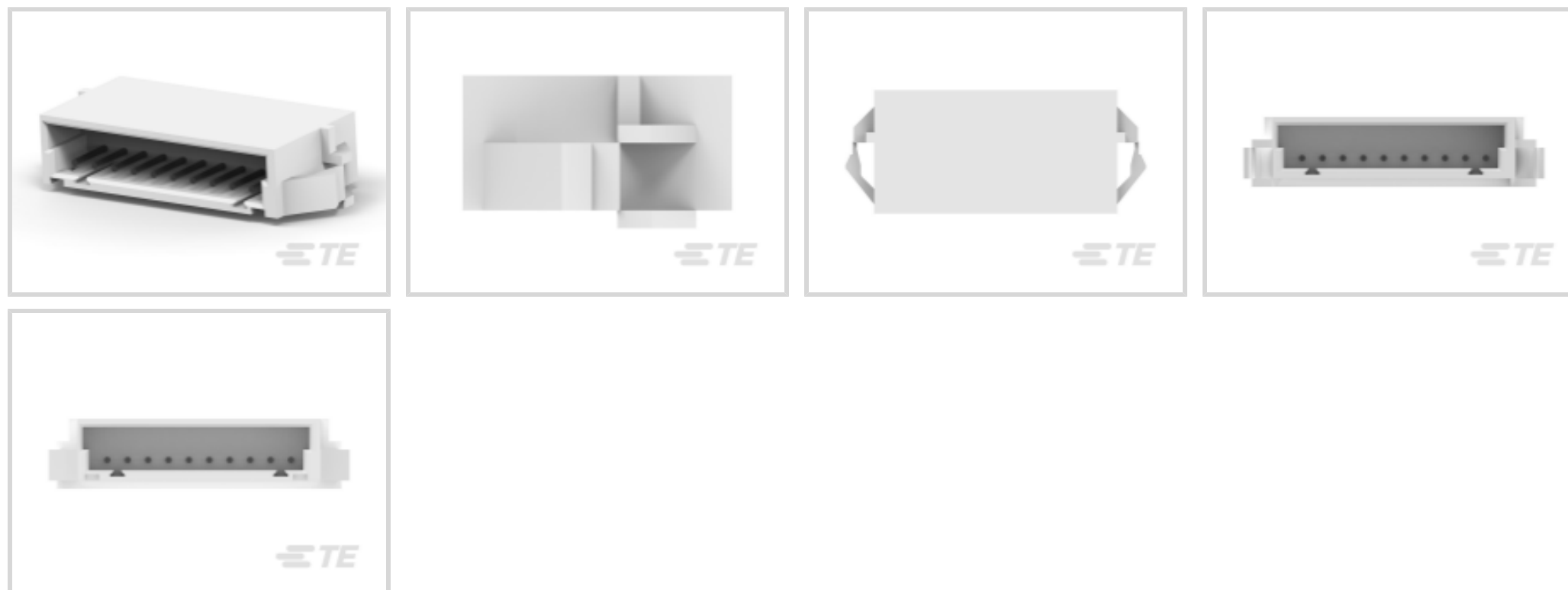

Connector Product Type: **Connector Assembly**

Connector & Housing Type: **Plug to Plug Relay Header**

Connector System: **Wire-to-Panel**

Number of Positions: **10**

Centerline (Pitch): **2 mm [.078 in]**

Features

Industry Standards

Compatible With Agency/Standards Products	UL, CSA
UL Flammability Rating	UL 94V-0
Compatible With Approved Standards Products	UL Recognized

Electrical Characteristics

Operating Voltage	125 V
-------------------	-------

Packaging Features

Packaging Method	Bag & Box
Packaging Quantity	300

Dimensions

Connector Width	6 mm [.236 in]
Panel Thickness (Recommended)	.81 – 1.6 mm [.032 – .063 in]
Connector Height	12 mm [.472 in]
Connector Length	23.78 mm [.936 in]



Contact Features

Contact Retention Within Housing	Without
Contact Base Material	Brass
Contact Type	Pin
Contact Current Rating (Max)	4 A

Mechanical Attachment

Panel Mount Feature Type	Latches
Strain Relief	Without
Panel Mount Feature	With
Mating Retention Type	Locking Latch
Mating Retention	With
Connector Mounting Type	Panel Mount

Housing Features

Housing Material	Nylon 66
Centerline (Pitch)	2 mm [.078 in]

Product Type Features

Connector Product Type	Connector Assembly
Connector & Housing Type	Plug to Plug Relay Header
Connector System	Wire-to-Panel
Sealable	No

Configuration Features

Number of Positions	10
Number of Rows	1

Body Features

Primary Product Color	Natural
-----------------------	---------

Usage Conditions

Operating Temperature Range	-40 – 105 °C [-40 – 221 °F]
-----------------------------	-----------------------------

Operation/Application

Circuit Application	Signal
---------------------	--------

Other

EU RoHS Compliance	Compliant
EU ELV Compliance	Compliant



Product Compliance

[For compliance documentation, visit the product page on TE.com>](#)

EU RoHS Directive 2011/65/EU	Compliant
EU ELV Directive 2000/53/EC	Compliant
China RoHS 2 Directive MIIT Order No 32, 2016	No Restricted Materials Above Threshold
EU REACH Regulation (EC) No. 1907/2006	Current ECHA Candidate List: JUNE 2024 (241) Candidate List Declared Against: JUNE 2024 (241) Does not contain REACH SVHC
Halogen Content	Low Halogen - Br, Cl, F, I < 900 ppm per homogenous material. Also BFR/CFR/PVC Free
Solder Process Capability	Not applicable for solder process capability

Product Compliance Disclaimer

This information is provided based on reasonable inquiry of our suppliers and represents our current actual knowledge based on the information they provided. This information is subject to change. The part numbers that TE has identified as EU RoHS compliant have a maximum concentration of 0.1% by weight in homogenous materials for lead, hexavalent chromium, mercury, PBB, PBDE, DBP, BBP, DEHP, DIBP, and 0.01% for cadmium, or qualify for an exemption to these limits as defined in the Annexes of Directive 2011/65/EU (RoHS2). Finished electrical and electronic equipment products will be CE marked as required by Directive 2011/65/EU. Components may not be CE marked. Additionally, the part numbers that TE has identified as EU ELV compliant have a maximum concentration of 0.1% by weight in homogenous materials for lead, hexavalent chromium, and mercury, and 0.01% for cadmium, or qualify for an exemption to these limits as defined in the Annexes of Directive 2000/53/EC (ELV). Regarding the REACH Regulation, the information TE provides on SVHC in articles for this part number is based on the latest European Chemicals Agency (ECHA) 'Guidance on requirements for substances in articles' posted at this URL: <https://echa.europa.eu/guidance-documents/guidance-on-reach>

Compatible Parts



Also in the Series | **AMP CT**



Connector Contacts(8)

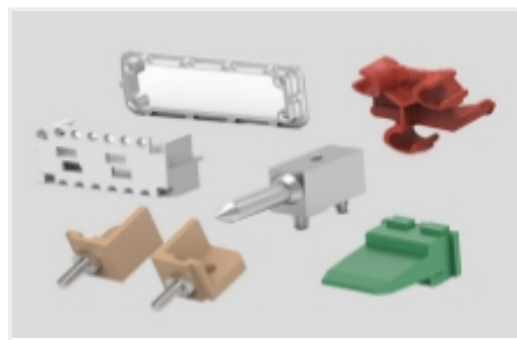

Connector Hardware(46)

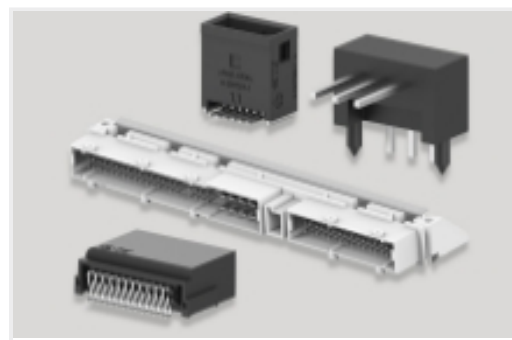

PCB Headers & Receptacles(756)

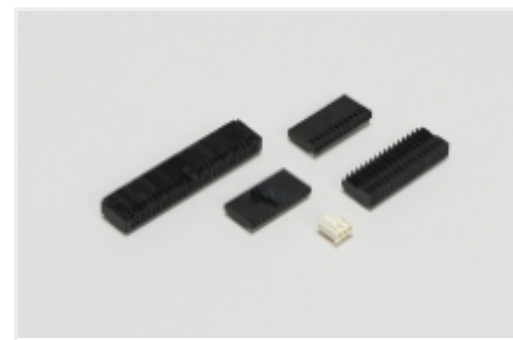

Wire-to-Board Connector Assemblies & Housings(255)

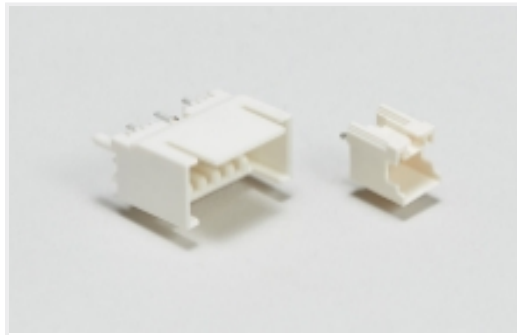

Wire-to-Board Headers & Receptacles (756)

Customers Also Bought

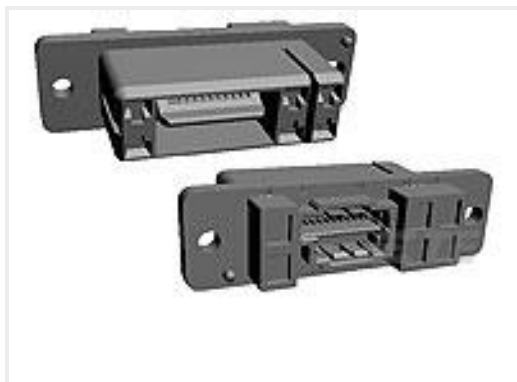

TE Part #2-1674755-0
REC ASSY FOR MINI CT HYBIRD DR

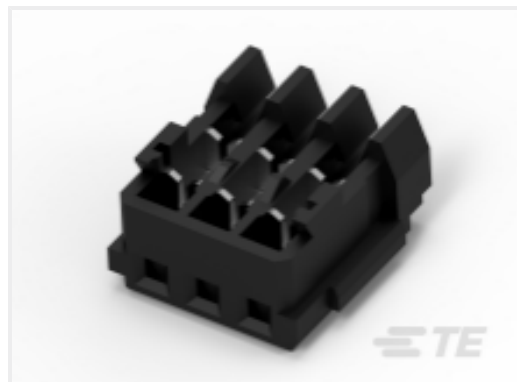

TE Part #2-353293-3
1.5MM CT MT REC ASS'Y 3P BLACK



TE Part #4-353294-0
AMP MINI D/R HDR HSG 40P NATU



TE Part #3-353294-0
AMP MINI D/R HDR HSG 30P NATU



TE Part #3-353293-0
1.5MM CT MT REC ASSY 10P BLACK



TE Part #292254-9
CT RELAY HDR ASSY 9P NAT



TE Part #292156-6
CT RELAY HDR ASSY FREE HANGING



TE Part #3-353293-4
1.5MM CT MT REC ASSY 14P BLACK

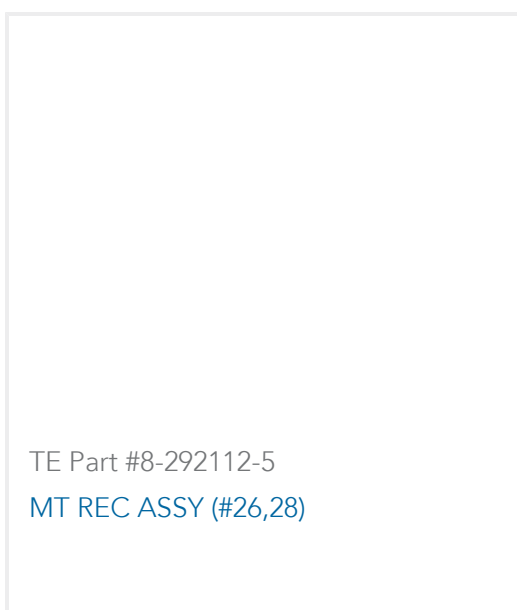

TE Part #8-292112-5
MT REC ASSY (#26,28)

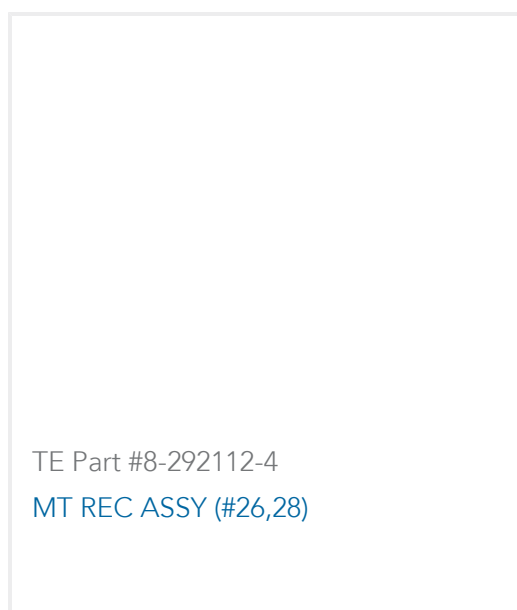

TE Part #8-292112-4
MT REC ASSY (#26,28)

Documents



Product Drawings

CT RELAY HDR ASSY 10P NAT

English

CAD Files

3D PDF

3D

Customer View Model

[ENG_CVM_CVM_1-292254-0_D.2d_dxf.zip](#)

English

Customer View Model

[ENG_CVM_CVM_1-292254-0_D.3d_igs.zip](#)

English

Customer View Model

[ENG_CVM_CVM_1-292254-0_D.3d_stp.zip](#)

English

By downloading the CAD file I accept and agree to the [Terms and Conditions](#) of use.

Product Specifications

AMP COMMON TERMINATION (CT), CONNECTOR, 2mm PITCH, M/T TYPE, LEAD FREE VERSION

Japanese

Product Specification

Japanese

Agency Approvals

Agency Approval Document

English