

1-292227-2 ✓ ACTIVE

AMP Mini CT

TE Internal #: 1-292227-2

PCB Mount Header, Right Angle, Wire-to-Board, 12 Position, 1.5 mm [.059 in] Centerline, Fully Shrouded, Tin, Surface Mount, Signal, AMP Mini CT

[View on TE.com >](#)



Connectors > PCB Connectors > PCB Headers & Receptacles



PCB Connector Assembly Type: **PCB Mount Header**

PCB Mount Orientation: **Right Angle**

Connector System: **Wire-to-Board**

Number of Positions: **12**

Number of Rows: **1**

Features

Electrical Characteristics

Operating Voltage	50 VDC
-------------------	--------

Dimensions

Connector Width	4.9 mm[.192 in]
PCB Thickness (Recommended)	.8 mm[.031 in]
Connector Height	7.7 mm[.303 in]
Connector Length	22.5 mm[.886 in]

Packaging Features

Packaging Quantity	200
Packaging Method	Reel

Industry Standards

Compatible With Agency/Standards Products	UL, CSA
Compatible With Approved Standards Products	UL E28476, CSA LR7189
UL Flammability Rating	UL 94V-0

Operation/Application

Assembly Process Feature	Pick and Place Cover
Circuit Application	Signal

Mechanical Attachment

Mating Retention Type	Latch
-----------------------	-------



Mating Retention	With
Mating Alignment Type	Polarization
PCB Mount Retention Type	Solder Peg
PCB Mount Alignment Type	Locating Posts
PCB Mount Retention	With
PCB Mount Alignment	With
Connector Mounting Type	Board Mount
Mating Alignment	With

Termination Features

Square Termination Post & Tail Dimension	.5 mm[.02 in]
Termination Method to PCB	Surface Mount

Contact Features

Mating Square Post Dimension	.5 mm[.02 in]
PCB Contact Termination Area Plating Material Thickness	1 μ m[39.37 μ in]
Contact Shape & Form	Square
Contact Layout	Inline
Contact Mating Area Length	2.4 mm[.095 in]
Contact Base Material	Brass
PCB Contact Termination Area Plating Material	Pre-Tin
Contact Mating Area Plating Material	Tin
Contact Type	Pin
Contact Current Rating (Max)	2 A

Housing Features

Housing Material	Nylon 6T
Centerline (Pitch)	1.5 mm[.059 in]

Product Type Features

PCB Connector Assembly Type	PCB Mount Header
Connector System	Wire-to-Board
Header Type	Fully Shrouded
Sealable	No
Connector & Contact Terminates To	Printed Circuit Board

Configuration Features



PCB Mount Orientation	Right Angle
Number of Positions	12
Number of Rows	1

Body Features

Primary Product Color	Natural
-----------------------	---------

Usage Conditions

Operating Temperature Range	-30 – 105 °C[-22 – 221 °F]
-----------------------------	----------------------------

Other

EU RoHS Compliance	Compliant
EU ELV Compliance	Compliant

Product Compliance

[For compliance documentation, visit the product page on TE.com>](#)

EU RoHS Directive 2011/65/EU	Compliant
EU ELV Directive 2000/53/EC	Compliant
China RoHS 2 Directive MIIT Order No 32, 2016	No Restricted Materials Above Threshold
EU REACH Regulation (EC) No. 1907/2006	Current ECHA Candidate List: JUNE 2024 (241) Candidate List Declared Against: JUNE 2024 (241) Does not contain REACH SVHC
Halogen Content	Not Low Halogen - contains Br or Cl > 900 ppm.
Solder Process Capability	Reflow solder capable to 245°C

Product Compliance Disclaimer

This information is provided based on reasonable inquiry of our suppliers and represents our current actual knowledge based on the information they provided. This information is subject to change. The part numbers that TE has identified as EU RoHS compliant have a maximum concentration of 0.1% by weight in homogenous materials for lead, hexavalent chromium, mercury, PBB, PBDE, DBP, BBP, DEHP, DIBP, and 0.01% for cadmium, or qualify for an exemption to these limits as defined in the Annexes of Directive 2011/65/EU (RoHS2). Finished electrical and electronic equipment products will be CE marked as required by Directive 2011/65/EU. Components may not be CE marked. Additionally, the part numbers that TE has identified as EU ELV compliant have a maximum concentration of 0.1% by weight in homogenous materials for lead, hexavalent chromium, and mercury, and 0.01% for cadmium, or qualify for an exemption to these limits as defined in the Annexes of Directive 2000/53/EC (ELV). Regarding the REACH Regulation, the information TE provides on SVHC in articles for this part number is based on the latest European Chemicals Agency (ECHA) 'Guidance on requirements for substances in articles' posted at this URL: <https://echa.europa.eu/guidance-documents/guidance-on-reach>

Compatible Parts

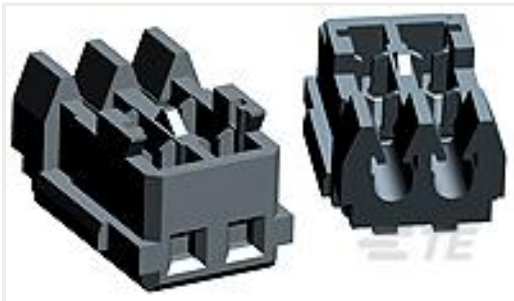

TE Part # 6-353293-2
MINI CT MT REC ASSY 12P BLUR



TE Part # CAT-AM7053-H8172
Mini Common Termination (CT) Housings



TE Part # CAT-AM7053-C7671
Mini Common Termination Contacts



TE Part # 1-353293-2
MINI CT MT REC ASSY 12P GRAY

Also in the Series | AMP Mini CT



Connector Contacts(4)

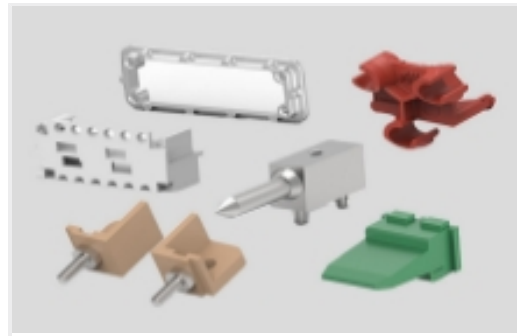

Connector Hardware(10)

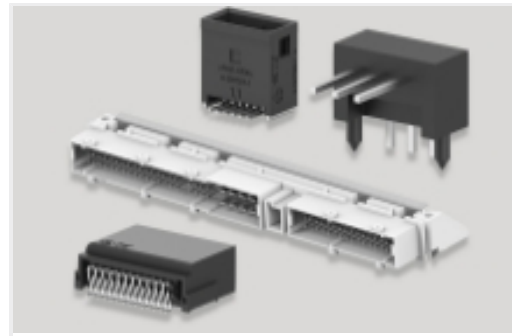

PCB Headers & Receptacles(332)

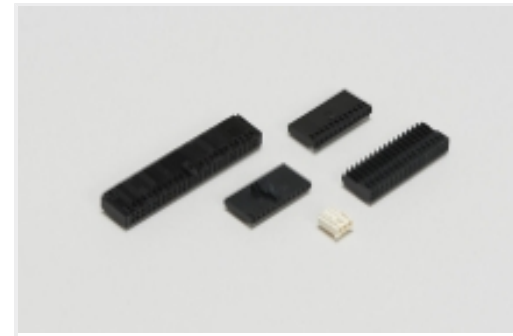

Wire-to-Board Connector Assemblies & Housings(172)

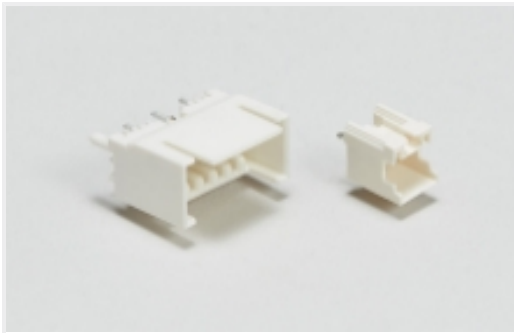

Wire-to-Board Headers & Receptacles (332)

Customers Also Bought



TE Part #2-292227-5
1.5 MINI CT SGL H SMT W/BOSS 5



TE Part #1-292230-0
1.5 MINI CT SGL V SMT W/BOSS 1

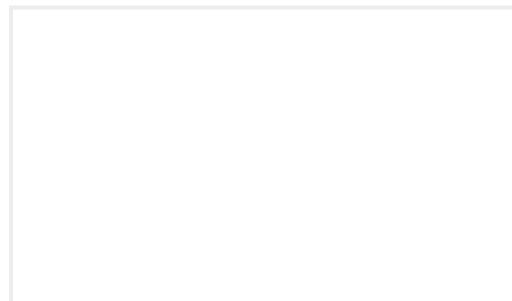

TE Part #1-2308397-3
1.5 MINI CT SGL V SMT W/BOSS 13

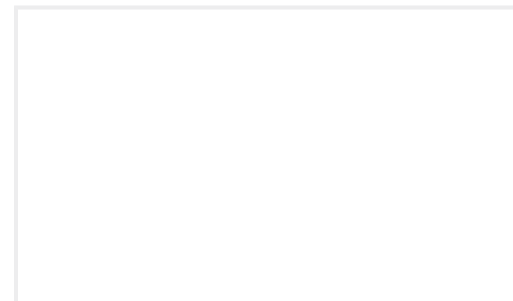

TE Part #1-2308397-9
1.5 MINI CT SGL V SMT W/BOSS 19

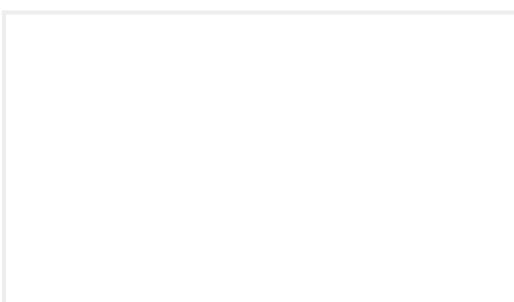

TE Part #2-2308397-0
1.5 MINI CT SGL V SMT W/BOSS 20



TE Part #1-1612257-2
REC ASSY 12P ,MINI CT DC DRAW

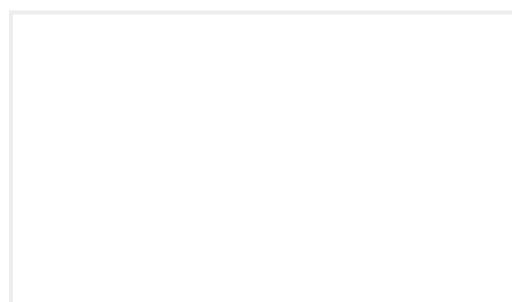

TE Part #1-2308397-5
1.5 MINI CT SGL V SMT W/BOSS 15

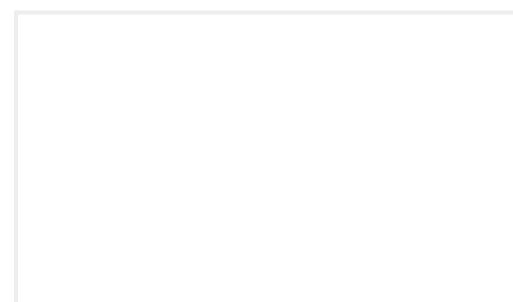

TE Part #1-2308397-4
1.5 MINI CT SGL V SMT W/BOSS 14



TE Part #1-292207-2
MINI CT SGL DIP V 12P NAT



TE Part #8-292131-3
SGL HDR ASSY BOX DIP V POLARIS

Documents

Product Drawings

[1.5 MINI CT SGL H SMT W BOSS 1](#)

English

CAD Files

[3D PDF](#)

3D

Customer View Model

[ENG_CVM_CVM_1-292227-2_A1.2d_dxf.zip](#)

English

Customer View Model

[ENG_CVM_CVM_1-292227-2_A1.3d_igs.zip](#)

English

Customer View Model

[ENG_CVM_CVM_1-292227-2_A1.3d_stp.zip](#)

English

By downloading the CAD file I accept and agree to the [Terms and Conditions](#) of use.

Product Specifications

[Application Specification](#)

English

Agency Approvals

[UL](#)

English