

1-2363638-2 ✓ ACTIVE

LUMAWISE | LUMAWISE Endurance S

TE Internal #: 1-2363638-2

Connector, Black, 27.4 mm Height, Keyed / Not Vented, UL, 4 Position, Sealable, Wire & Cable, -40 – 90 °C [-40 – 194 °F], LUMAWISE Endurance S

[View on TE.com >](#)



Connectors > Lighting Connectors > Street Lighting Controls > Street Lighting Connectors

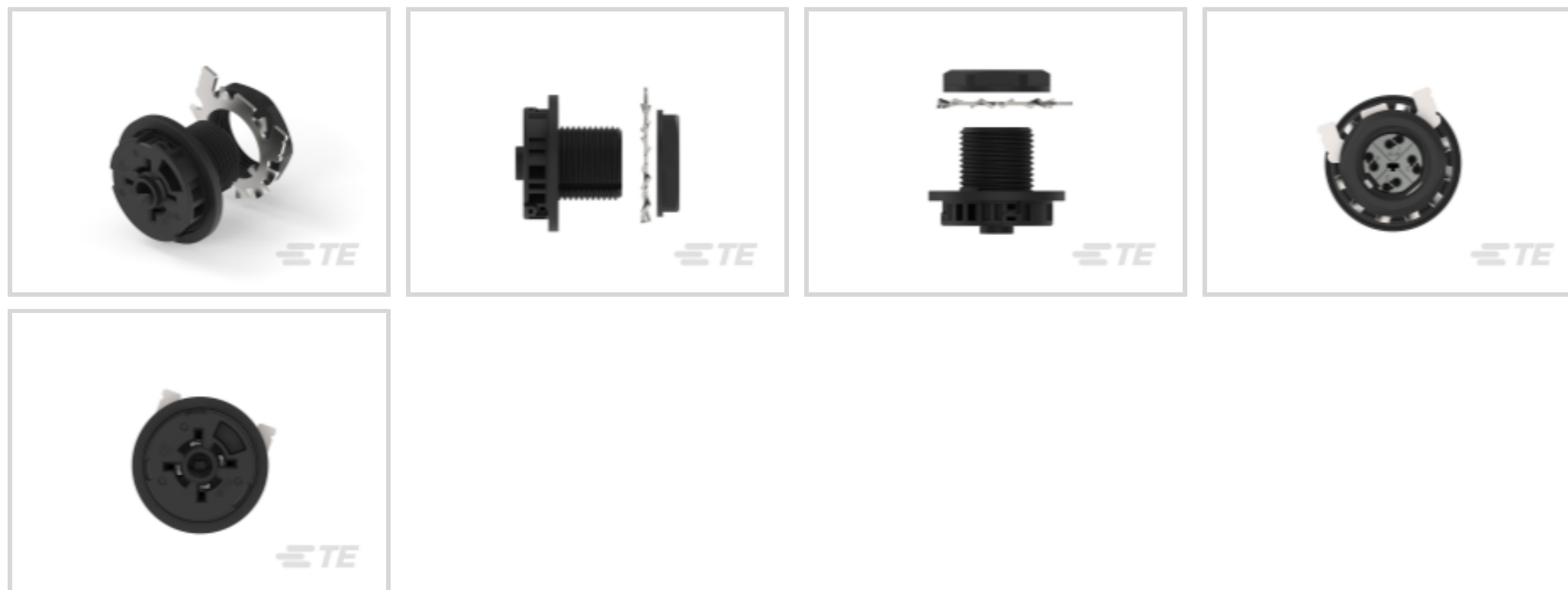

Lighting Product Type: **Connector**

Primary Product Color: **Black**

Product Height: **27.4 mm**

Lighting Connector Features Included: **Keyed, Not Vented**

Compatible With Agency/Standards Products: **UL**

Features

Product Type Features

Lighting Product Type	Connector
Sealable	Yes
Connector & Contact Terminates To	Wire & Cable

Configuration Features

Lighting Connector Features Included	Keyed, Not Vented
Number of Positions	4

Body Features

Primary Product Color	Black
-----------------------	-------

Contact Features

Contact Current Rating (Max)	1.5 A
------------------------------	-------

Dimensions

Product Diameter	36.5 mm
Product Height	27.4 mm



Usage Conditions

Operating Temperature Range	-40 – 90 °C[-40 – 194 °F]
-----------------------------	---------------------------

Industry Standards

IP Rating	IP66
Compatible With Agency/Standards Products	UL

Product Compliance

[For compliance documentation, visit the product page on TE.com>](#)

EU RoHS Directive 2011/65/EU	Compliant
EU ELV Directive 2000/53/EC	Compliant
China RoHS 2 Directive MIIT Order No 32, 2016	有害物质含量符合标准要求 No Restricted Substance(s) Above Threshold
EU REACH Regulation (EC) No. 1907/2006	Current ECHA Candidate List: JUNE 2025 (250) Candidate List Declared Against: JAN 2023 (233) Does not contain REACH SVHC
Halogen Content	Not Yet Reviewed for halogen content
Solder Process Capability	Not applicable for solder process capability

Product Compliance Disclaimer

This information is provided based on reasonable inquiry of our suppliers and represents our current actual knowledge based on the information they provided. This information is subject to change. The part numbers that TE has identified as EU RoHS compliant have a maximum concentration of 0.1% by weight in homogenous materials for lead, hexavalent chromium, mercury, PBB, PBDE, DBP, BBP, DEHP, DIBP, and 0.01% for cadmium, or qualify for an exemption to these limits as defined in the Annexes of Directive 2011/65/EU (RoHS2). Finished electrical and electronic equipment products will be CE marked as required by Directive 2011/65/EU. Components may not be CE marked. Additionally, the part numbers that TE has identified as EU ELV compliant have a maximum concentration of 0.1% by weight in homogenous materials for lead, hexavalent chromium, and mercury, and 0.01% for cadmium, or qualify for an exemption to these limits as defined in the Annexes of Directive 2000/53/EC (ELV). Regarding the REACH Regulation, the information TE provides on SVHC in articles for this part number is based on the latest European Chemicals Agency (ECHA) 'Guidance on requirements for substances in articles' posted at this URL: <https://echa.europa.eu/guidance-documents/guidance-on-reach>

Compatible Parts



TE Part # 1-2343404-1
MODULE ASSY, 80MM LUMAWISE S, KEYED, vented



TE Part # 2341474-2
SEALING CAP, RCPT, LUMAWISE ENDURANCE S



TE Part # 2341474-1
SEALING CAP, RCPT, LUMAWISE ENDURANCE S



TE Part # 2-2343404-1
MODULE, 80MM LUMAWISE ENDURANCE S, KEYED



TE Part # 2382635-1
LUMAWISE POWER INPUT TERMINAL BLOCK (TB)



TE Part # 2343405-1
MODULE, 40MM LUMAWISE ENDURANCE S, KEYED



TE Part # 2396687-5
SEALING CAP, RCPT, LUMAWISE ENDURANCE S

Also in the Series | LUMAWISE Endurance S

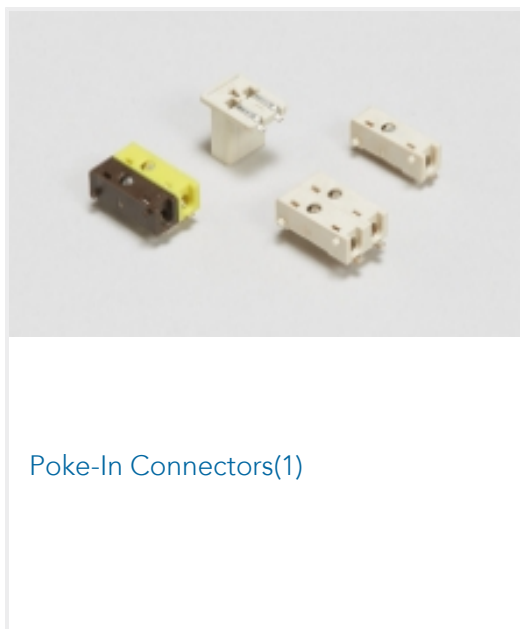

Poke-In Connectors(1)

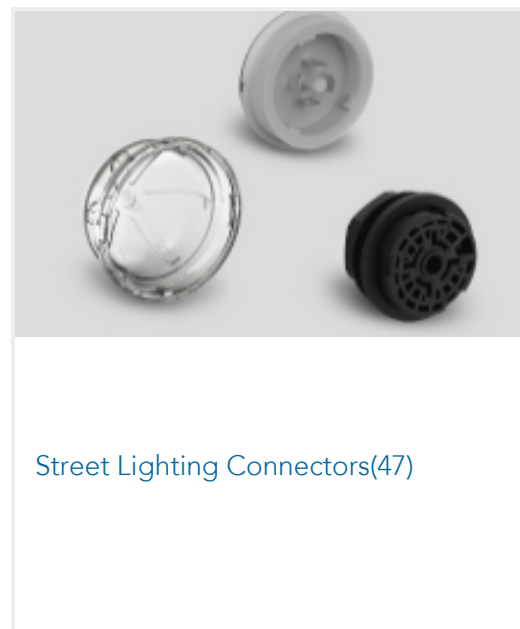

Street Lighting Connectors(47)

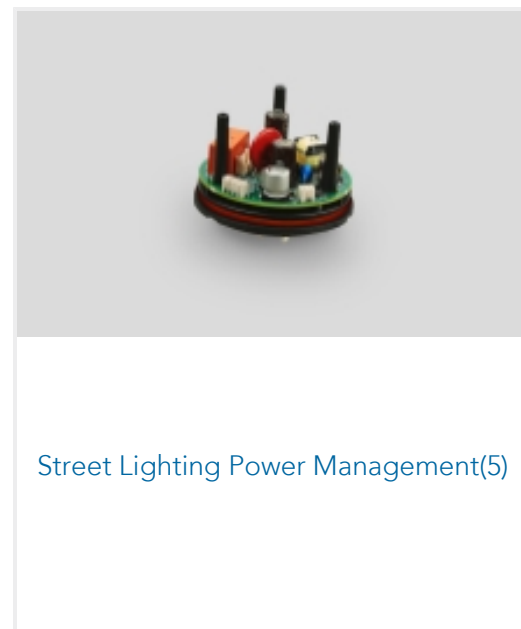

Street Lighting Power Management(5)

Customers Also Bought

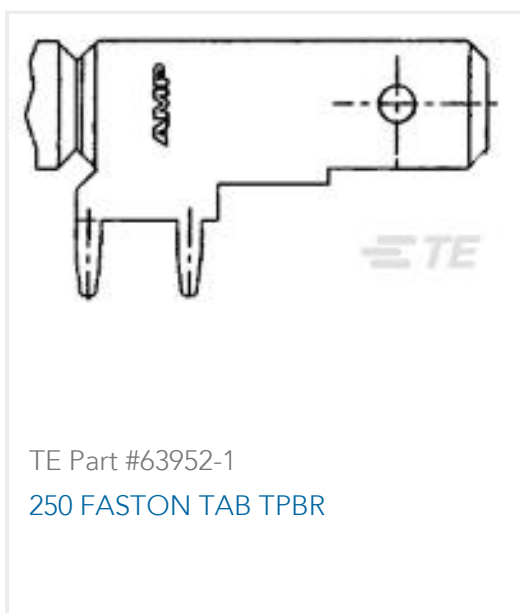

TE Part #63952-1
250 FASTON TAB TPBR



TE Part #826926-5
5P AMPMODU II STIFT LEI



TE Part #1-1123722-7
3.96 EP PLUG HSG 7P(NATURAL)

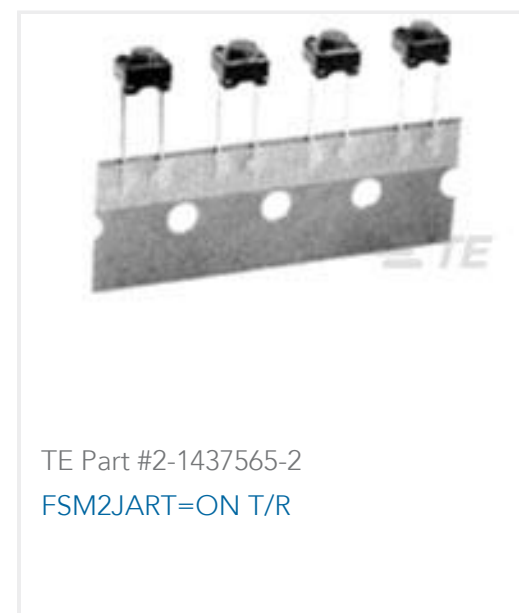

TE Part #2-1437565-2
FSM2JART=ON T/R



TE Part #6-1625892-1
3W SM M/OX 5% 5K6

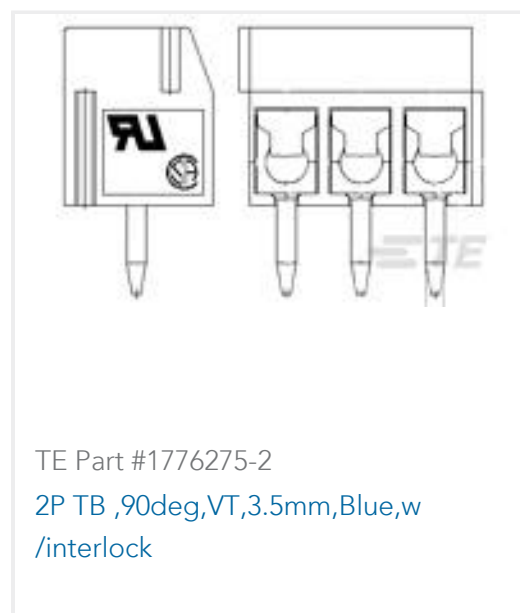

TE Part #1776275-2
2P TB, 90deg, VT, 3.5mm, Blue, w /interlock



TE Part #2-1879501-9
CRGH2512 5% 15R 2W



TE Part #2176243-1
CRGS0603 5% 1R0



Documents

Product Drawings

[Rcpt,LUMAWISE Endurance S2 Kit,KeyA,Dots](#)

English

CAD Files

Customer View Model

[ENG_CVM_CVM_1-2363638-2_A1.3d_stp.zip](#)

English

Customer View Model

[ENG_CVM_CVM_1-2363638-2_A1.3d_igs.zip](#)

English

3D PDF

3D

Customer View Model

[ENG_CVM_CVM_1-2363638-2_A1.2d_dxf.zip](#)

English

By downloading the CAD file I accept and agree to the [Terms and Conditions](#) of use.

Datasheets & Catalog Pages

[Datasheet - Lumawise Z10](#)

English

[Lumawise Endurance S Modules](#)

English

Product Specifications

[Application Specification](#)

English

Agency Approvals

[CB_CERT_IEC_61984_US_34131_M1_UL_C1](#)

English

[UL_EU_CERT_EN_61984_UL_EU_01778_M1_C1](#)

English

[CB_CERT_US_34131_M1_UL_4788988643_TR_C1](#)

English

1-2363638-2

Connector, Black, 27.4 mm Height, Keyed / Not Vented, UL, 4 Position, Sealable,
Wire & Cable, -40 – 90 °C [-40 – 194 °F], LUMAWISE Endurance S

