

1-172165-6 ✓ ACTIVE

MATE-N-LOK | Mini-Universal MATE-N-LOK

TE Internal #: 1-172165-6

Housing, Plug, Wire-to-Wire, 2 Position, 4.14 mm [.163 in]

Centerline, Wire & Cable, UL 94V-0, Mini-Universal MATE-N-LOK,

Rectangular Power Connectors

[View on TE.com >](#)



Connectors > Power Connectors > Rectangular Power > Rectangular Power Connectors

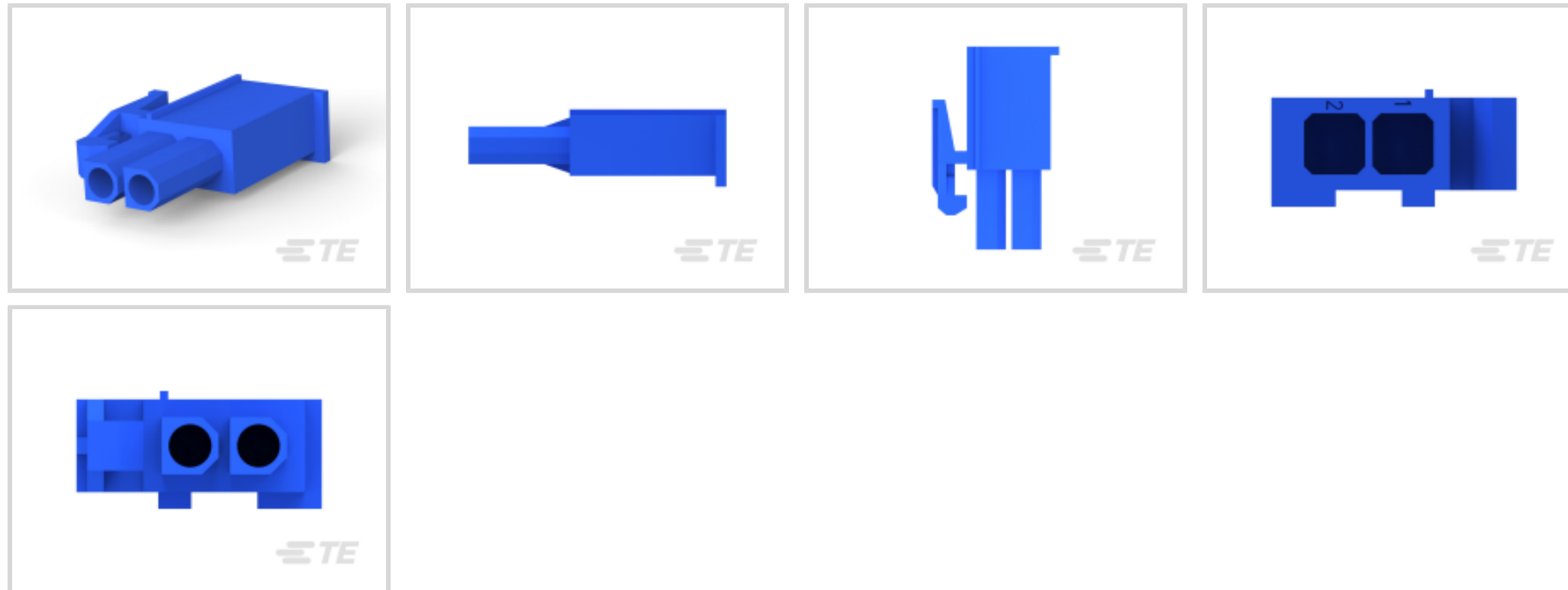

Rectangular Power Connector Type: **Housing**

Connector & Housing Type: **Plug**

Connector System: **Wire-to-Wire**

Number of Positions: **2**

Centerline (Pitch): **4.14 mm [.163 in]**

Features

Packaging Features

Packaging Quantity	1000
Packaging Method	Bag

Product Type Features

Rectangular Power Connector Type	Housing
Connector & Housing Type	Plug
Connector System	Wire-to-Wire
Sealable	No
Connector & Contact Terminates To	Wire & Cable

Configuration Features

Number of Positions	2
Number of Power Positions	2
Number of Signal Positions	0
Number of Rows	1

Electrical Characteristics



Operating Voltage	600 VDC
-------------------	---------

Contact Features

Contact Retention Within Housing	Without
----------------------------------	---------

Contact Type	Socket
--------------	--------

Termination Features

Termination Method to Wire & Cable	Crimp
------------------------------------	-------

Mechanical Attachment

Connector Mounting Type	Cable Mount (Free-Hanging)
-------------------------	----------------------------

Housing Features

Centerline (Pitch)	4.14 mm [.163 in]
--------------------	-------------------

Housing Color	Blue
---------------	------

Housing Material	Nylon 66/6
------------------	------------

Usage Conditions

Operating Temperature Range	-20 – 105 °C [-4 – 221 °F]
-----------------------------	----------------------------

Operation/Application

Circuit Application	Power & Signal
---------------------	----------------

Industry Standards

UL Flammability Rating	UL 94V-0
------------------------	----------

Glow Wire Rating	Standard Part - Not Glow Wire
------------------	-------------------------------

Other

EU RoHS Compliance	Compliant
--------------------	-----------

EU ELV Compliance	Compliant
-------------------	-----------

Product Compliance

[For compliance documentation, visit the product page on TE.com>](#)

EU RoHS Directive 2011/65/EU	Compliant
------------------------------	-----------

EU ELV Directive 2000/53/EC	Compliant
-----------------------------	-----------

China RoHS 2 Directive MIIT Order No 32, 2016	No Restricted Materials Above Threshold
---	---

EU REACH Regulation (EC) No. 1907/2006	Current ECHA Candidate List: JUNE 2024 (241) Candidate List Declared Against: JUNE 2024 (241) Does not contain REACH SVHC
--	---



Halogen Content

Low Halogen - Br, Cl, F, I < 900 ppm per homogenous material. Also BFR/CFR/PVC Free

Solder Process Capability

Not applicable for solder process capability

Product Compliance Disclaimer

This information is provided based on reasonable inquiry of our suppliers and represents our current actual knowledge based on the information they provided. This information is subject to change. The part numbers that TE has identified as EU RoHS compliant have a maximum concentration of 0.1% by weight in homogenous materials for lead, hexavalent chromium, mercury, PBB, PBDE, DBP, BBP, DEHP, DIBP, and 0.01% for cadmium, or qualify for an exemption to these limits as defined in the Annexes of Directive 2011/65/EU (RoHS2). Finished electrical and electronic equipment products will be CE marked as required by Directive 2011/65/EU. Components may not be CE marked. Additionally, the part numbers that TE has identified as EU ELV compliant have a maximum concentration of 0.1% by weight in homogenous materials for lead, hexavalent chromium, and mercury, and 0.01% for cadmium, or qualify for an exemption to these limits as defined in the Annexes of Directive 2000/53/EC (ELV). Regarding the REACH Regulation, the information TE provides on SVHC in articles for this part number is based on the latest European Chemicals Agency (ECHA) 'Guidance on requirements for substances in articles' posted at this URL: <https://echa.europa.eu/guidance-documents/guidance-on-reach>

Compatible Parts



TE Part # 794406-1
MINI UMNL CONT 20-16AWG SN



TE Part # 770985-1
MINI UMNL PIN 26-22AWG SN LP



TE Part # 170364-4
MINI UNIVERSAL M-N-L PIN LP



TE Part # 1-794406-0
MINI UMNL SOK 20-16 AWG AU LF



TE Part # 1-770835-0
MINI UMNL PIN AU LF



TE Part # 1-770902-1
MINI UMNL SOK 26-22 AWG AU LF



TE Part # 1-770904-1
MINI UMNL SOK 22-18AWG AU LF



TE Part # 1-794059-0
MINI UMNL PIN L/P LF



TE Part # 1-794407-1
MINI UMNL SOK 20-16 AWG AU LF



TE Part # 170360-3
MINI UNIVERSAL M-N-L PIN



TE Part # 170363-1
MINI UNIVERSAL M-N-L PIN LP



TE Part # 170364-3
MINI UNIVERSAL M-N-L PIN LP



Also in the Series | **Mini-Universal MATE-N-LOK**

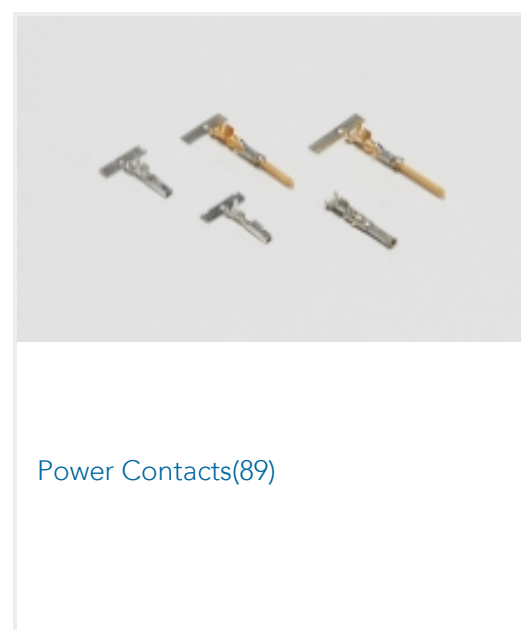
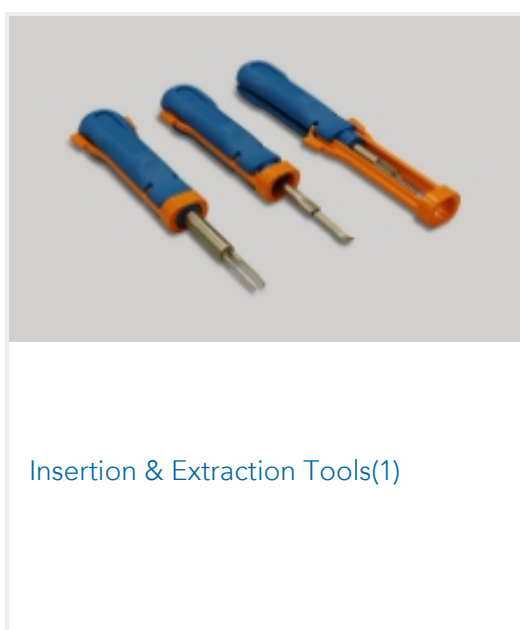
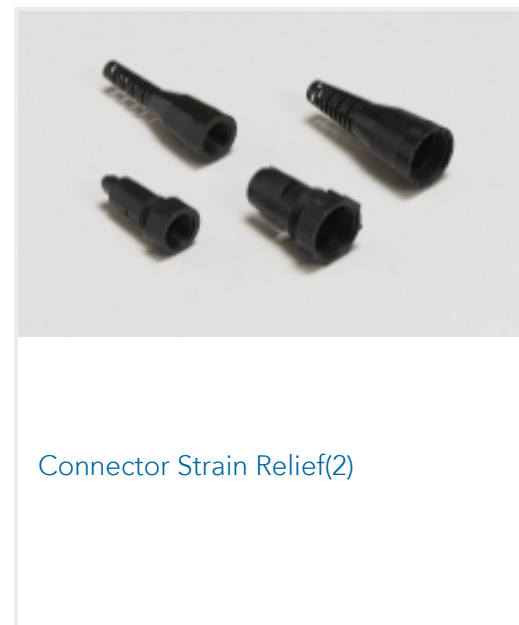
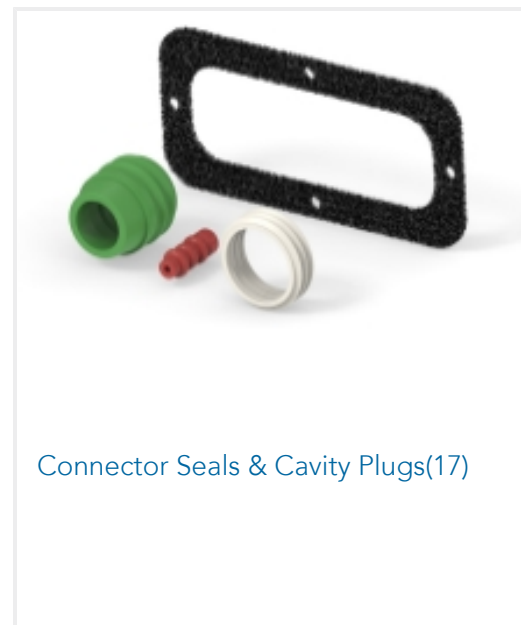
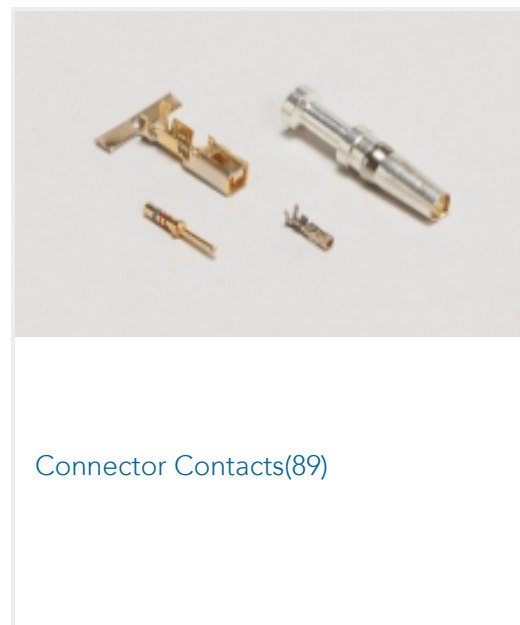

Customers Also Bought

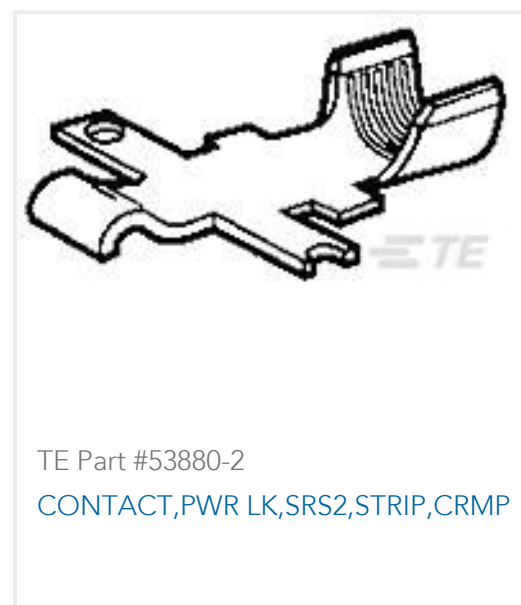

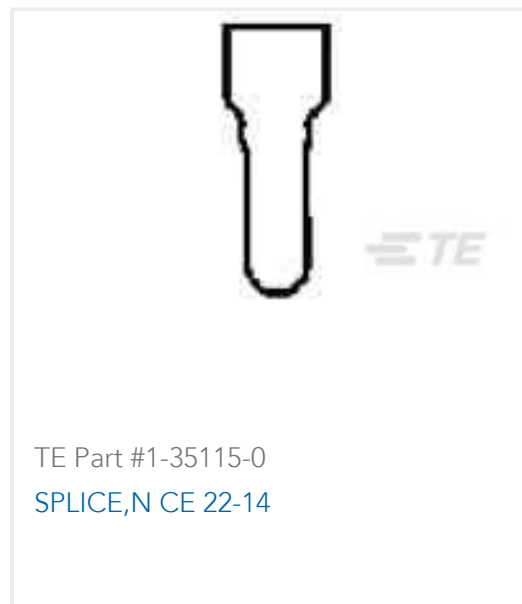

Documents

Product Drawings

[2CIR MINI U-M-N-L PLUG BLUE](#)

English

CAD Files

[3D PDF](#)

3D

Customer View Model

[ENG_CVM_CVM_1-172165-6_H.2d_dxf.zip](#)

English

Customer View Model

[ENG_CVM_CVM_1-172165-6_H.3d_igs.zip](#)

English

Customer View Model

[ENG_CVM_CVM_1-172165-6_H.3d_stp.zip](#)

English

By downloading the CAD file I accept and agree to the [Terms and Conditions](#) of use.

Product Specifications

[Engineering Report](#)

English

Instruction Sheets

[Instruction Sheet \(U.S.\)](#)

English

Agency Approvals

[UL Report](#)

1-172165-6

Housing, Plug, Wire-to-Wire, 2 Position, 4.14 mm [.163 in] Centerline, Wire & Cable,
UL 94V-0, Mini-Universal MATE-N-LOK, Rectangular Power Connectors



English