

# HSC100220RJ ✓ ACTIVE

CGS | CGS HS

TE Internal #: 1-1625999-8

220 ohm, Wire Wound, 5 %, Power Resistor, 100 W, 2 Terminations,  
±30 ppm/°C, Solder Lug, Loose Piece - Tray, 26 mm [1.024 in]

Height, CGS HS

[View on TE.com >](#)



Passive Components > Resistors > Chassis Mount Resistors > Power Resistors: Aluminium Housed, HSC

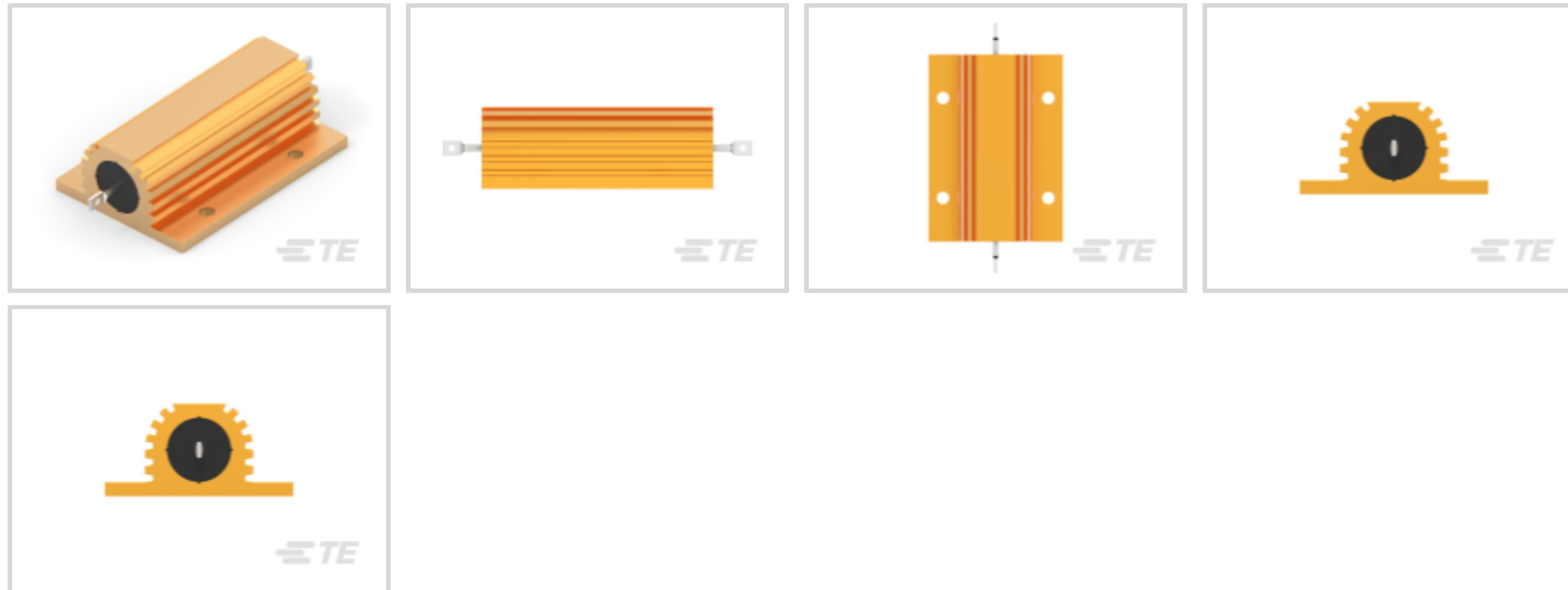

Resistor Type: **Power Resistor**

Resistance Class: **Up to 1kΩ**

Resistance Value: **220 Ω**

Power Rating: **100 W**

Element Type: **Wire Wound**

[All Power Resistors: Aluminium Housed, HSC \(485\)](#)

## Features

### Product Type Features

Resistor Type	Power Resistor
Element Type	Wire Wound

### Configuration Features

Number of Resistors	1
---------------------	---

### Electrical Characteristics

Operating Voltage	1900 VDC
Resistance Class	Up to 1kΩ
Resistance Value	220 Ω
Power Rating	100 W
Passive Component Tolerance	5 %

### Termination Features

Number of Terminations	2
------------------------	---

Chassis Mount Resistor Termination Type

Solder Lug

### Mechanical Attachment

Panel Mount Feature Type

Flange with Mounting Holes

### Dimensions

Product Height

26 mm[1.024 in]

Product Length

87.5 mm[3.445 in]

Product Width

47.5 mm[1.87 in]

### Usage Conditions

Temperature Coefficient

 $\pm 30$  ppm/ $^{\circ}\text{C}$ 

### Packaging Features

Packaging Method

Loose Piece - Tray

## Product Compliance

For compliance documentation, visit the product page on [TE.com](https://www.te.com)>

EU RoHS Directive 2011/65/EU

Compliant

EU ELV Directive 2000/53/EC

Compliant

China RoHS 2 Directive MIIT Order No 32, 2016

有害物质含量符合标准要求 No Restricted Substance(s) Above Threshold

EU REACH Regulation (EC) No. 1907/2006

Current ECHA Candidate List: JUNE 2025 (250)  
 Candidate List Declared Against: JUNE 2025 (250)  
 Does not contain REACH SVHC

Halogen Content

Low Halogen - Br, Cl, F < 900 ppm per homogenous material. Also BFR/CFR/PVC Free

Solder Process Capability

Hand solderable with lead free solder

#### Product Compliance Disclaimer

This information is provided based on reasonable inquiry of our suppliers and represents our current actual knowledge based on the information they provided. This information is subject to change. The part numbers that TE has identified as EU RoHS compliant have a maximum concentration of 0.1% by weight in homogenous materials for lead, hexavalent chromium, mercury, PBB, PBDE, DBP, BBP, DEHP, DIBP, and 0.01% for cadmium, or qualify for an exemption to these limits as defined in the Annexes of Directive 2011/65/EU (RoHS2). Finished electrical and electronic equipment products will be CE marked as required by Directive 2011/65/EU. Components may not be CE marked. Additionally, the part numbers that TE has identified as EU ELV compliant have a maximum concentration of 0.1% by weight in homogenous materials for lead, hexavalent chromium, and mercury, and 0.01% for cadmium, or qualify for an exemption to these limits as defined in the Annexes of Directive 2000/53/EC (ELV). Regarding the REACH Regulation, the information TE provides on SVHC in articles for this part number is based on the latest European Chemicals Agency (ECHA) 'Guidance on requirements for substances in articles' posted at this URL: <https://echa.europa.eu/guidance-documents/guidance-on-reach>

## Compatible Parts



TE Part # 1625999-3  
HSC100 10R 5%

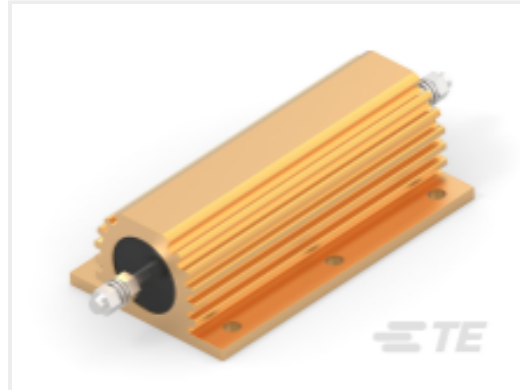

TE Part # 1630027-1  
HSC300 100R 5%

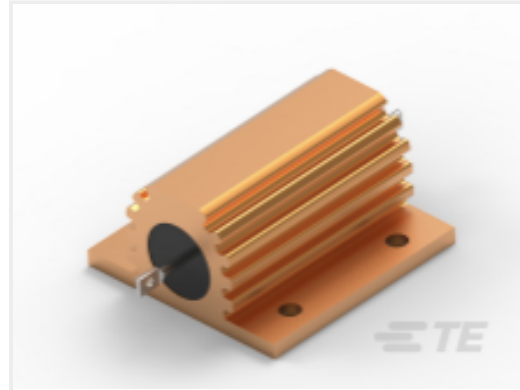

TE Part # CAT-C339-H85913  
Power Resistors: Aluminum Housed,  
HSA

## Also in the Series | CGS HS



Automotive Housings(1)

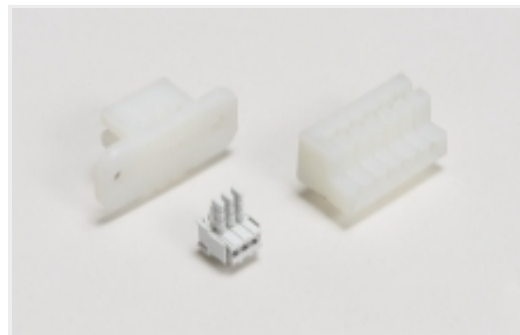

Card Edge Connector Housings(1)



FFC Connectors(1)

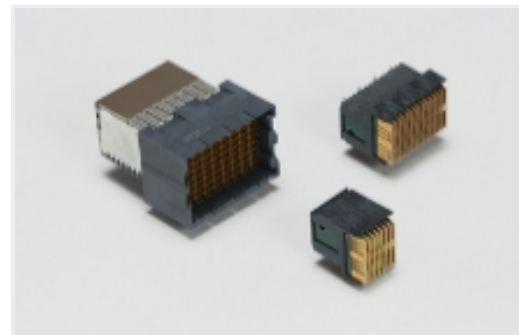

High Speed Backplane Connectors(10)

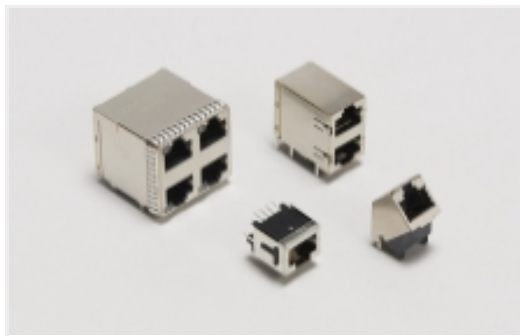

RJ45 Connectors(1)

## Customers Also Bought



TE Part #802524-SF  
FN2030B-30-08



TE Part #803409-SF  
FN2090B-30-08



TE Part #66740-1  
TYPE XII FEMALE CONT (STRIP)

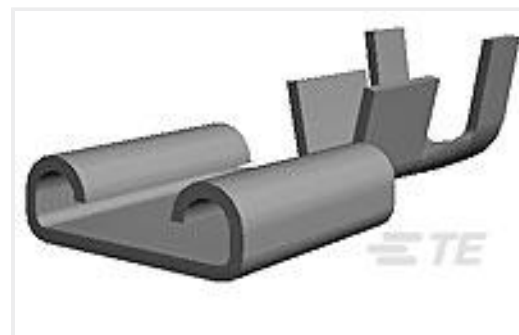

TE Part #5-160506-8  
250 FASTON REC 20-16 AWG TPBZ



TE Part #2-480416-5  
250 FASTON HSG.,REC.,1 POS,  
NATURAL



TE Part #2-1393250-9  
W28-XQ1A-14=W28

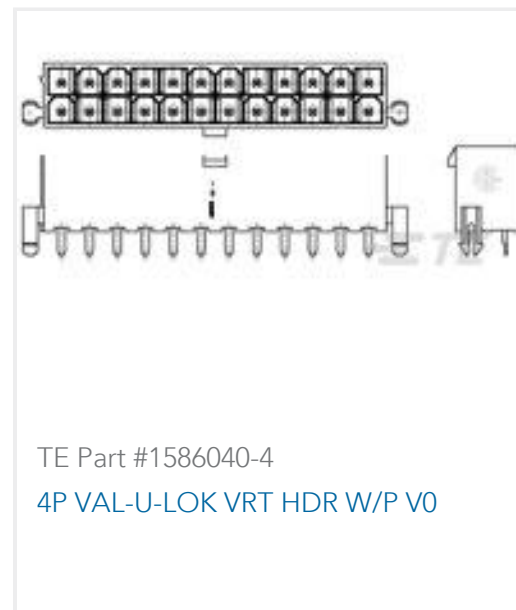

TE Part #1586040-4  
4P VAL-U-LOK VRT HDR W/P V0



TE Part #2-1625999-8  
HSC100 330R 5%

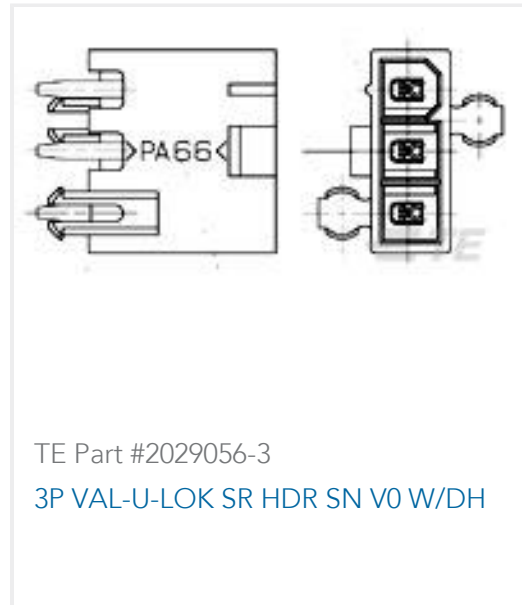

TE Part #2029056-3  
3P VAL-U-LOK SR HDR SN V0 W/DH

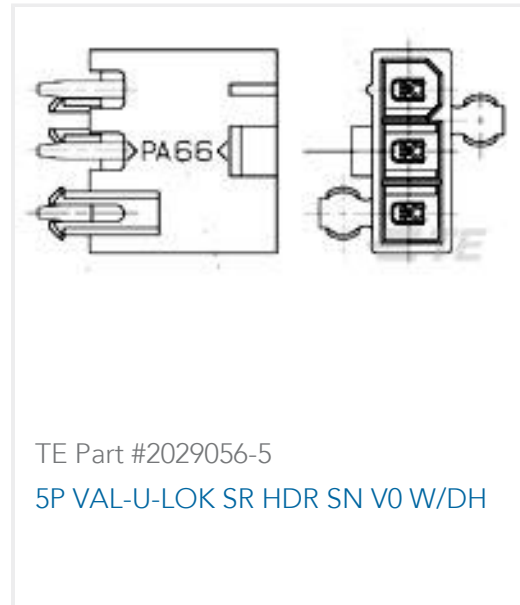

TE Part #2029056-5  
5P VAL-U-LOK SR HDR SN V0 W/DH

## Documents

### Product Drawings

#### HSC100 220R 5%

English

### CAD Files

#### 3D PDF

3D

#### Customer View Model

[ENG\\_CVM\\_CVM\\_1-1625999-8\\_AH.2d\\_dxf.zip](#)

English

#### Customer View Model

[ENG\\_CVM\\_CVM\\_1-1625999-8\\_AH.3d\\_igs.zip](#)

English

#### Customer View Model

[ENG\\_CVM\\_CVM\\_1-1625999-8\\_AH.3d\\_stp.zip](#)

English

By downloading the CAD file I accept and agree to the [Terms and Conditions](#) of use.

### Datasheets & Catalog Pages

#### 4-1773460-6\_RESISTIVE\_SOLUTIONS\_RAIL

English

#### 1309350\_PASSIVE\_COMPONENT

English

#### Aluminium Housed Power Resistors - Type HS Series

English

#### 8-1773459-4\_POWER\_FILTERING\_AND\_RESISTIVE\_SOLUTIONS\_FOR\_ELEVATORS\_AND\_ESCALATORS

English

HSC100220RJ

220 ohm, Wire Wound, 5 %, Power Resistor, 100 W, 2 Terminations,  $\pm 30$  ppm/ $^{\circ}$ C,  
Solder Lug, Loose Piece - Tray, 26 mm [1.024 in] Height, CGS HS

