



RAYCHEM

TE Internal #: 053007-000

Straight Heat Shrink Boot, 202 Shape Code, Lipped, 25 Material Code, 25 Material Systems Code, Adhesive Precoat, -75 – 150 °C [-103 – 302 °F]

[View on TE.com >](#)

Wire Protection & Management > Heat Shrink Shapes > Heat Shrink Boots > Low Profile Heat Shrink Boots: Poly Molded, Lipped, Straight

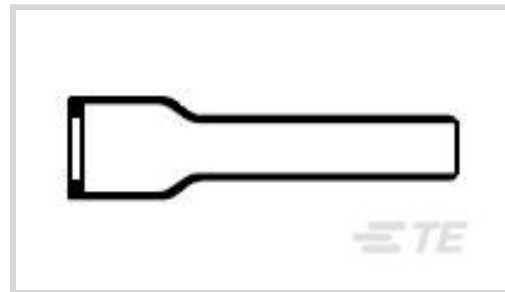

Body Orientation: **Straight**

Molded Part Shape Code: **202**

Lipped: **Yes**

Material Code: **25**

Material Systems Code: **25**

[All Low Profile Heat Shrink Boots: Poly Molded, Lipped, Straight \(143\)](#)

Features

Industry Standards

Compatible With Approved Standards Products	VG95343 Parts 6,7,8 and 9
---	---------------------------

Dimensions

Expanded Inside Diameter (Min)	43.7 mm[1.72 in]
--------------------------------	------------------

Body Features

Primary Product Material	Fluid Resistant Modified Elastomer
Material Code	25
Material Systems Code	25

Configuration Features

Lipped	Yes
Adhesive Requirement	Adhesive Precoat

Housing Features

Body Orientation	Straight
------------------	----------

Usage Conditions

Operating Temperature Range	-75 – 150 °C[-103 – 302 °F]
Resistance Protection	Long-Term Fluid Exposure at High Temperatures



Other

Molded Part Shape Code	202
Adhesive Code	86
EU RoHS Compliance	Compliant
EU ELV Compliance	Compliant

Product Compliance



[For compliance documentation, visit the product page on TE.com>](#)

EU RoHS Directive 2011/65/EU	Compliant
EU ELV Directive 2000/53/EC	Compliant
China RoHS 2 Directive MIIT Order No 32, 2016	No Restricted Materials Above Threshold
EU REACH Regulation (EC) No. 1907/2006	Current ECHA Candidate List: JUNE 2024 (241) Candidate List Declared Against: JUNE 2024 (241) Does not contain REACH SVHC
Halogen Content	Not Low Halogen - contains Br or Cl > 900 ppm.
Solder Process Capability	Not applicable for solder process capability

Product Compliance Disclaimer

This information is provided based on reasonable inquiry of our suppliers and represents our current actual knowledge based on the information they provided. This information is subject to change. The part numbers that TE has identified as EU RoHS compliant have a maximum concentration of 0.1% by weight in homogenous materials for lead, hexavalent chromium, mercury, PBB, PBDE, DBP, BBP, DEHP, DIBP, and 0.01% for cadmium, or qualify for an exemption to these limits as defined in the Annexes of Directive 2011/65/EU (RoHS2). Finished electrical and electronic equipment products will be CE marked as required by Directive 2011/65/EU. Components may not be CE marked. Additionally, the part numbers that TE has identified as EU ELV compliant have a maximum concentration of 0.1% by weight in homogenous materials for lead, hexavalent chromium, and mercury, and 0.01% for cadmium, or qualify for an exemption to these limits as defined in the Annexes of Directive 2000/53/EC (ELV). Regarding the REACH Regulation, the information TE provides on SVHC in articles for this part number is based on the latest European Chemicals Agency (ECHA) 'Guidance on requirements for substances in articles' posted at this URL: <https://echa.europa.eu/guidance-documents/guidance-on-reach>

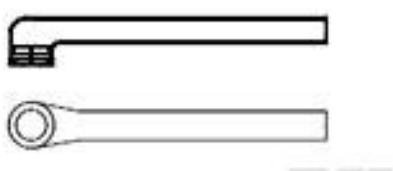
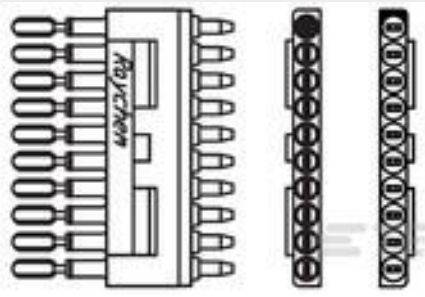
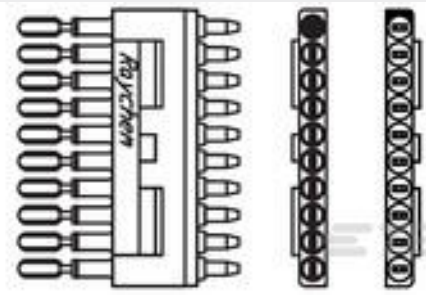
Customers Also Bought

 <p>TE Part #122827-000 222D232-25-02/86-0</p>	 <p>TE Part #699318-000 MTC100-JB2-P11-T15</p>	 <p>TE Part #699316-000 MTC100-JA2-P11-T13</p>	 <p>TE Part #662293-000 202D232-25-08/86-0</p>
---	---	---	---

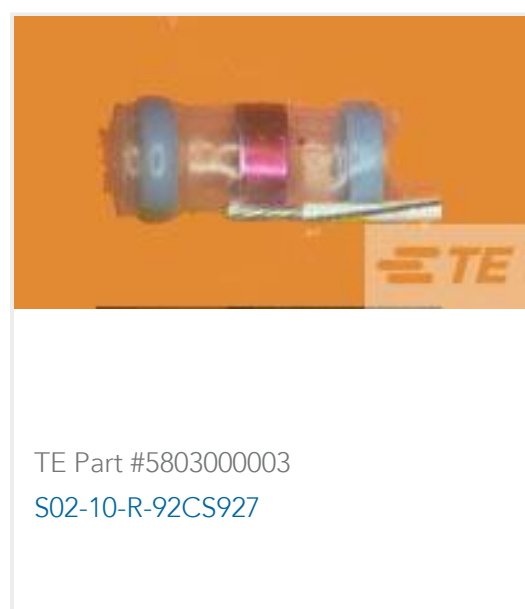
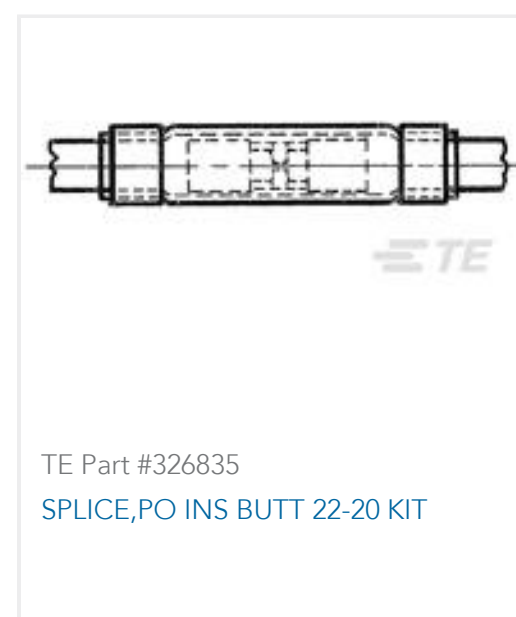
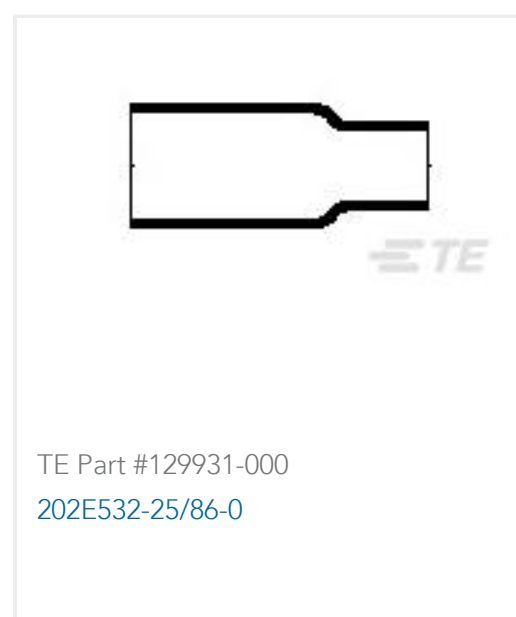

Documents

Product Drawings

[202D263-25-08/86-0](#)

English

Datasheets & Catalog Pages

[1654025_Sec4_-25](#)

English

Raychem Molded Parts Visual Guide

English

Product Specifications

[Product Specification](#)

English