

839036-E ✓ ACTIVE

ERNI | ERNI MiniBridge

TE Internal #: 839036-E

6 Position, Cable Assembly Length .3 m [.98 ft], Gray Cable, .14 mm² Wire, 26 AWG, Socket Housing End A, Socket Housing End B, VW-1

[View on TE.com >](#)



Cable Assemblies > Copper Cable Assemblies > High Speed I/O Cable Assemblies



Number of Positions: 6

Cable Assembly Length: .3 m [.98 ft]

Cable Color: Gray

Shielded: No

Wire Size: .14 mm²

Features

Product Type Features

Cable Style	Discrete Pair
Cable Assembly (End A)	Socket Housing
Cable Assembly (End B)	Socket Housing

Configuration Features

Mounting Location	External
Number of Positions	6

Electrical Characteristics

Impedance	100 Ω
-----------	-------

Body Features

Cable Color	Gray
Cable Flammability Rating	VW-1

Contact Features

Contact Mating Area Plating Material	Gold (Au)
--------------------------------------	-----------



Mechanical Attachment

Mating Alignment	With
------------------	------

Housing Features

Housing Material	Liquid Crystal Polymer (LCP)
------------------	------------------------------

Dimensions

Wire Size	26 AWG
Outside Cable Diameter	1 mm [.039 in]

Operation/Application

Shielded	No
----------	----

Other

Cable Assembly Configuration	Double Ended
Cable Assembly Length	.3 m [.98 ft]

Product Compliance

[For compliance documentation, visit the product page on TE.com>](#)

EU RoHS Directive 2011/65/EU	Compliant
EU ELV Directive 2000/53/EC	Not Yet Reviewed
China RoHS 2 Directive MIIT Order No 32, 2016	有害物质含量符合标准要求 No Restricted Substance(s) Above Threshold
EU REACH Regulation (EC) No. 1907/2006	Current ECHA Candidate List: FEB 2026 (253) Candidate List Declared Against: JUNE 2023 (235) Does not contain REACH SVHC
Halogen Content	Not Yet Reviewed for halogen content
Solder Process Capability	Not reviewed for solder process capability

Product Compliance Disclaimer

This information is provided based on reasonable inquiry of our suppliers and represents our current actual knowledge based on the information they provided. This information is subject to change. The part numbers that TE has identified as EU RoHS compliant have a maximum concentration of 0.1% by weight in homogenous materials for lead, hexavalent chromium, mercury, PBB, PBDE, DBP, BBP, DEHP, DIBP, and 0.01% for cadmium, or qualify for an exemption to these limits as defined in the Annexes of Directive 2011/65/EU (RoHS2). Finished electrical and electronic equipment products will be CE marked as required by Directive 2011/65/EU. Components may not be CE marked. Additionally, the part numbers that TE has identified as EU ELV compliant have a maximum concentration of 0.1% by weight in homogenous materials for lead, hexavalent chromium, and mercury, and 0.01% for cadmium, or qualify for an exemption to these limits as defined in the Annexes of Directive 2000/53/EC (ELV). Regarding the REACH Regulation, the information TE provides on SVHC in articles for this part number is based on the latest European Chemicals Agency (ECHA) 'Guidance on requirements for substances in articles' posted at this URL: <https://echa.europa.eu/guidance-documents/guidance-on-reach>

Compatible Parts

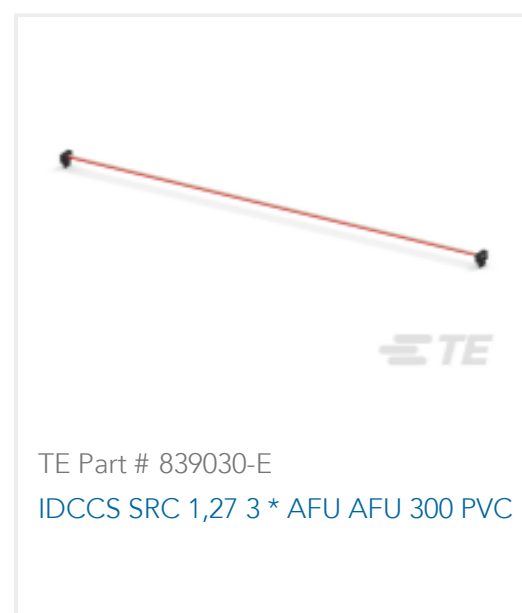
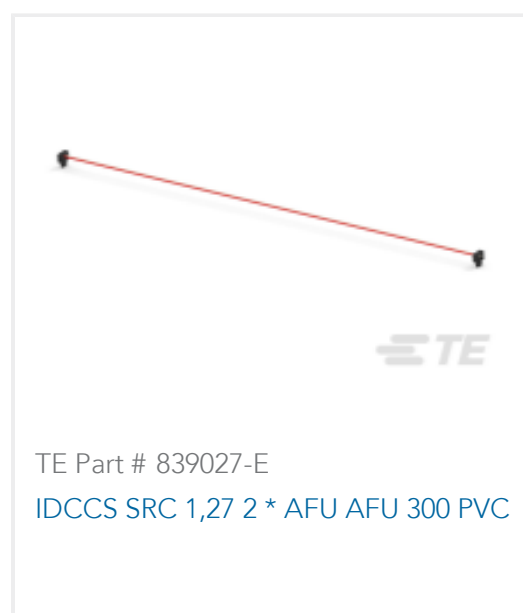

Also in the Series | ERNI MiniBridge

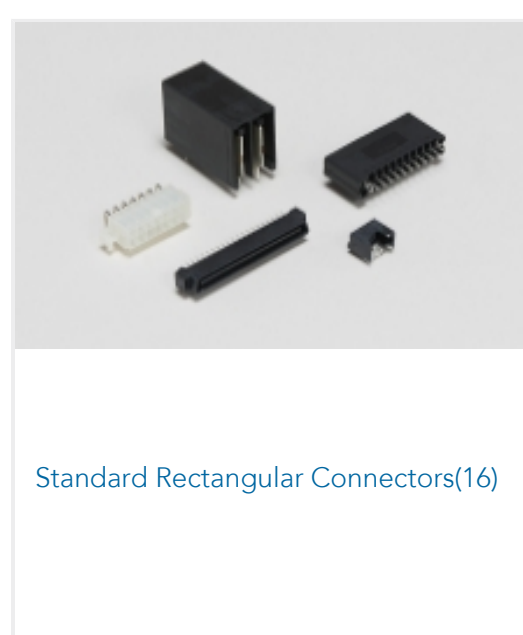
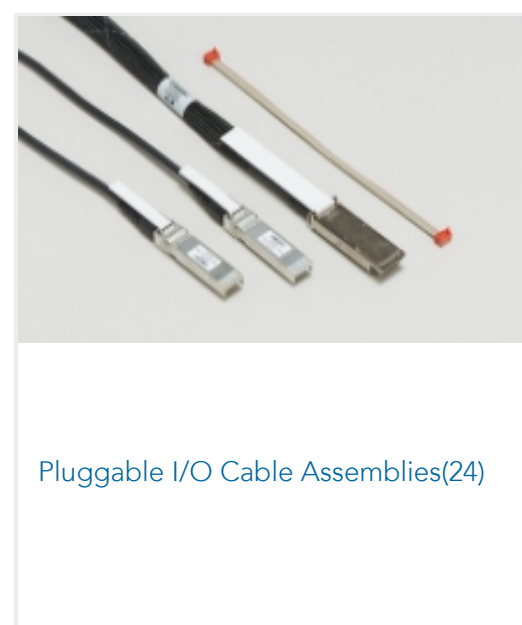
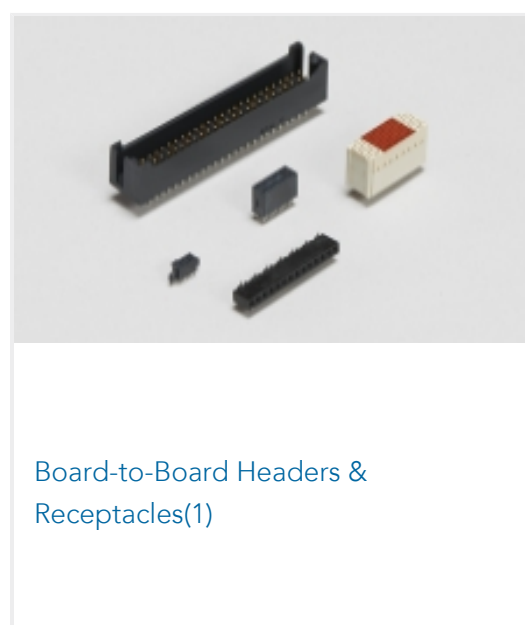

Customers Also Bought

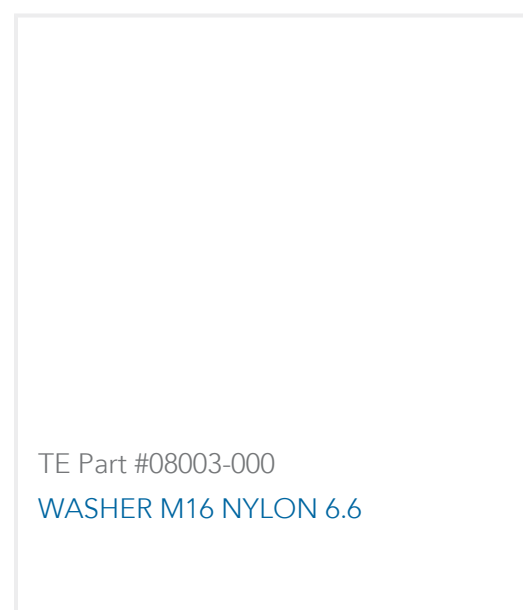
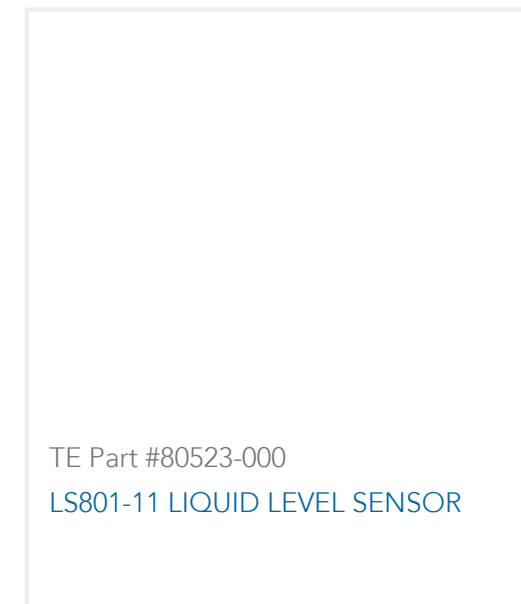
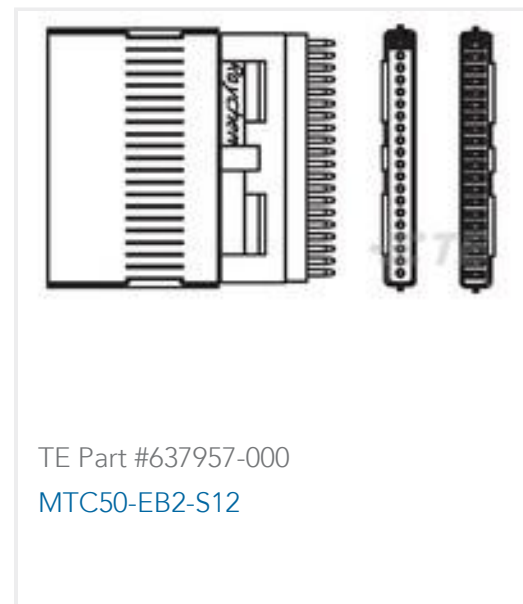

Documents

CAD Files

Customer View Model

[ENG_CVM_CVM_839036-E_A.3d_igs.zip](#)

English

Customer View Model

[ENG_CVM_CVM_839036-E_A.3d_stp.zip](#)

English

Customer View Model

[ENG_CVM_CVM_839036-E_A.2d_dxf.zip](#)

English

3D PDF

3D

By downloading the CAD file I accept and agree to the [Terms and Conditions](#) of use.

Datasheets & Catalog Pages

[Datasheet - ERNI MiniBridge 1.27mm Connectors](#)

English

[Datasheet - ERNI MiniBridge 1.27mm Connectors](#)

German

839036-E

6 Position, Cable Assembly Length .3 m [.98 ft], Gray Cable, .14 mm² Wire, 26 AWG,
Socket Housing End A, Socket Housing End B, VW-1

