



Part Number : [1300150070](#)

Product Description : Mini-Change C-Size Receptacle, 12 Poles, 1/2" - 14 NPT Threads, Female (Straight) to 16 AWG Leads, 0.5m (1.64') Length

Series Number : 130015

Status : Active

Product Category : Circular Industrial Connectors

Engineering Number : 3R2004A20M005

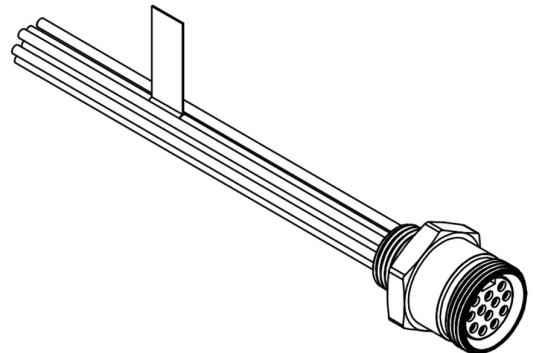

Documents & Resources

Drawings

[1300150070_sd.pdf](#)

Product Environment Compliance

Compliance

GADSL/IMDS	Not Relevant
China RoHS	
EU ELV	Not Relevant
Low-Halogen Status	Not Low-Halogen per IEC 61249-2-21
REACH SVHC	Contains Lead per D(2022)9120-DC (17 Jan 2023)
EU RoHS	Compliant with Exemption 6(c) per EU 2015/863

Multiple Part Product Compliance Statements

- Eu RoHS
- REACH SVHC
- Low-Halogen

Multiple Part Industry Compliance Documents

- IPC 1752A Class C
- IPC 1752A Class D
- Molex Product Compliance Declaration

- IEC-62474

- chemSHERPA (xml)

EU RoHS Certificate of Compliance

Part Details

General

Status	Active
Category	Circular Industrial Connectors
Series	130015
Description	Mini-Change C-Size Receptacle, 12 Poles, 1/2" - 14 NPT Threads, Female (Straight) to 16 AWG Leads, 0.5m (1.64') Length
Comments	C-Size (1-1/8" - 16 UN-2A)
IP Rating	IP67
Product Name	Mini-Change
Type	Single Ended (pigtail)
UPC	78678884587

Agency

CSA	LR6837
UL	E152210

Electrical

Current - Maximum per Contact	5.0A
Voltage - Maximum	600V AC/DC

Physical

Coupling Type	External Thread
Gender	Female
Keyway	Single
Length	0.50m
Material - Component	Zinc Die-Cast with Black Epoxy
Mounting Thread Size	1/2" - 14 NPT
Net Weight	44.000/g
Orientation	Straight

Panel Mount	Front
Poles	12
Temperature Range - Operating	-20° to +105°C
Wire/Cable Type	UL 1015
Wire Size (AWG)	16

This document was generated on Feb 13, 2025