



RAST | RAST 5

TE Internal #: 1-2371464-2

2 Position, Plug, Housing, Crimp, Wire-to-Board, UL 94V-0, 5 mm [.197 in] Centerline, 1 Row, Wire & Cable, Power & Signal, RAST 5

[View on TE.com >](#)

Connectors > Rectangular Connectors > Standard Rectangular Connectors



Connector Product Type: **Housing**

Connector & Housing Type: **Plug**

Connector System: **Wire-to-Board**

UL Flammability Rating: **UL 94V-0**

Number of Positions: **2**

## Features

### Product Type Features

Connector Product Type	Housing
Connector & Housing Type	Plug
Connector System	Wire-to-Board
Sealable	No
Connector & Contact Terminates To	Wire & Cable

### Configuration Features

Number of Positions	2
Number of Rows	1

### Body Features

Primary Product Color	Natural
-----------------------	---------

### Contact Features

Contact Type	Receptacle
--------------	------------

### Termination Features

Termination Method to Wire & Cable	Crimp
------------------------------------	-------



### Mechanical Attachment

Contact Retention Type Within Housing	Locking Lance
Locking Latch Between Cavity Number	1 + 2
Mating Retention	With
Connector Mounting Type	Cable Mount (Free-Hanging)

### Housing Features

Centerline (Pitch)	5 mm [.197 in]
Housing Material	PA 66

### Usage Conditions

Operating Temperature Range	-40 – 110 °C [-40 – 230 °F]
-----------------------------	-----------------------------

### Operation/Application

Circuit Application	Power & Signal
---------------------	----------------

### Industry Standards

UL Flammability Rating	UL 94V-0
Glow Wire Rating	GWT 750°C (Without Flame)

### Product Compliance

[For compliance documentation, visit the product page on TE.com>](#)

EU RoHS Directive 2011/65/EU	Compliant
EU ELV Directive 2000/53/EC	Compliant
China RoHS 2 Directive MIIT Order No 32, 2016	有害物质含量符合标准要求 No Restricted Substance(s) Above Threshold
EU REACH Regulation (EC) No. 1907/2006	Current ECHA Candidate List: JUNE 2025 (250) Candidate List Declared Against: JUNE 2025 (250) Does not contain REACH SVHC
Halogen Content	Not Low Halogen - contains Br or Cl > 900 ppm.
Solder Process Capability	Not reviewed for solder process capability

#### Product Compliance Disclaimer

This information is provided based on reasonable inquiry of our suppliers and represents our current actual knowledge based on the information they provided. This information is subject to change. The part numbers that TE has identified as EU RoHS compliant have a maximum concentration of 0.1% by weight in homogenous materials for lead, hexavalent chromium, mercury, PBB, PBDE, DBP, BBP, DEHP, DIBP, and 0.01% for cadmium, or qualify for an exemption to these limits as defined in the Annexes of Directive 2011/65/EU (RoHS2). Finished electrical and electronic equipment products will be CE marked as required by Directive 2011/65/EU. Components may not be CE marked. Additionally, the part

numbers that TE has identified as EU ELV compliant have a maximum concentration of 0.1% by weight in homogenous materials for lead, hexavalent chromium, and mercury, and 0.01% for cadmium, or qualify for an exemption to these limits as defined in the Annexes of Directive 2000/53/EC (ELV). Regarding the REACH Regulation, the information TE provides on SVHC in articles for this part number is based on the latest European Chemicals Agency (ECHA) 'Guidance on requirements for substances in articles' posted at this URL: <https://echa.europa.eu/guidance-documents/guidance-on-reach>

## Compatible Parts



## Also in the Series | RAST 5

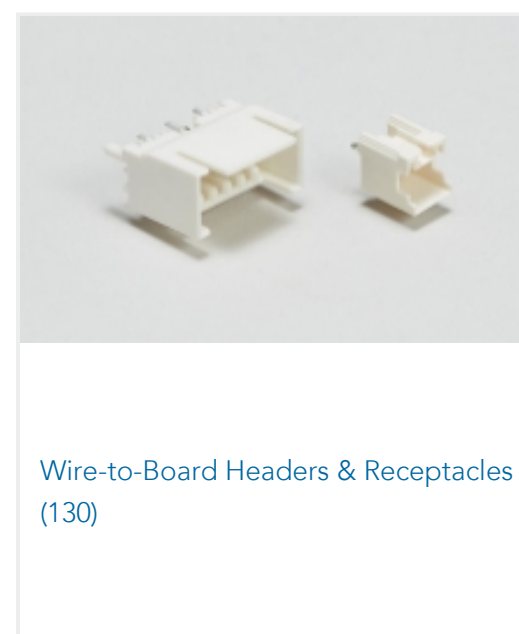
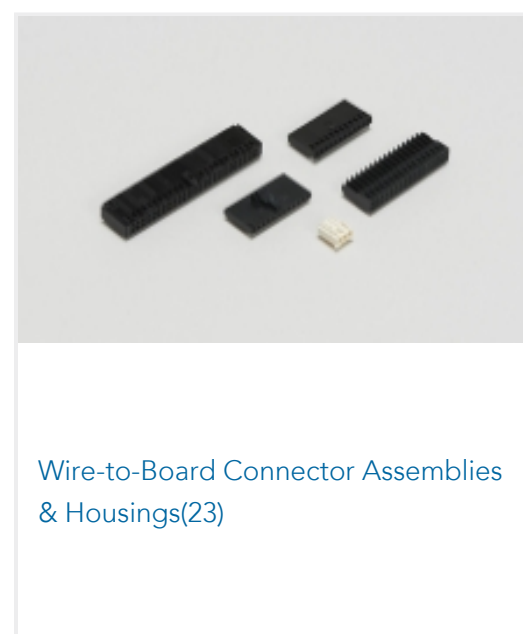
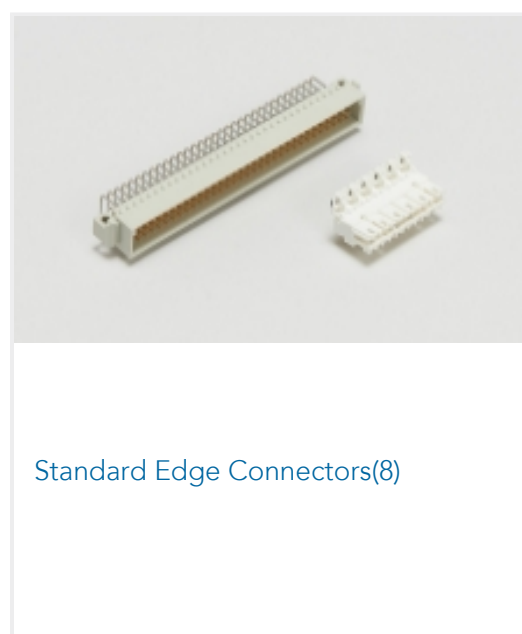
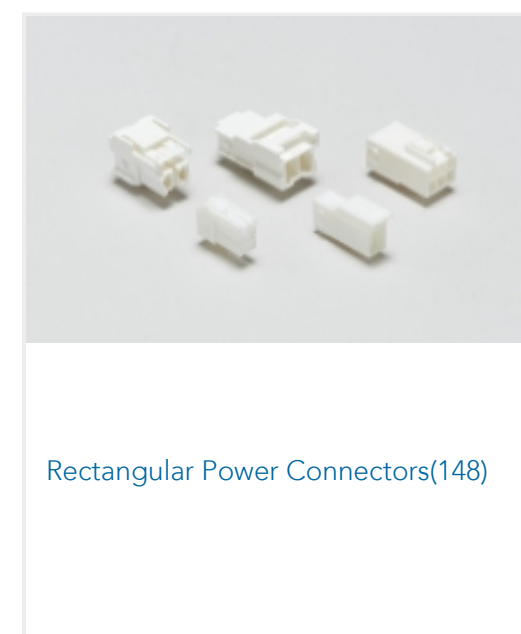
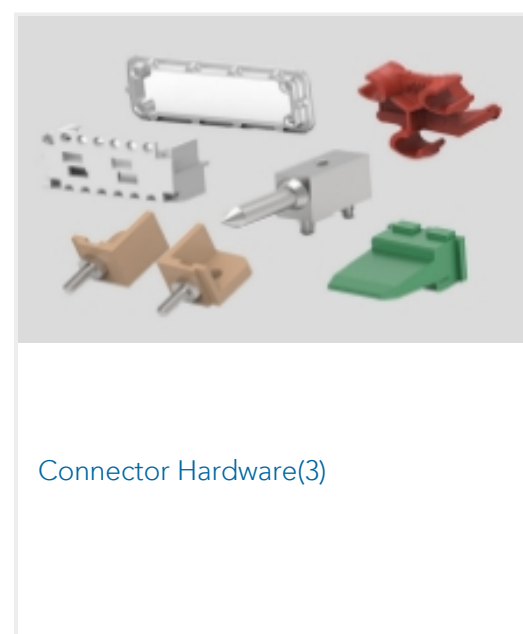
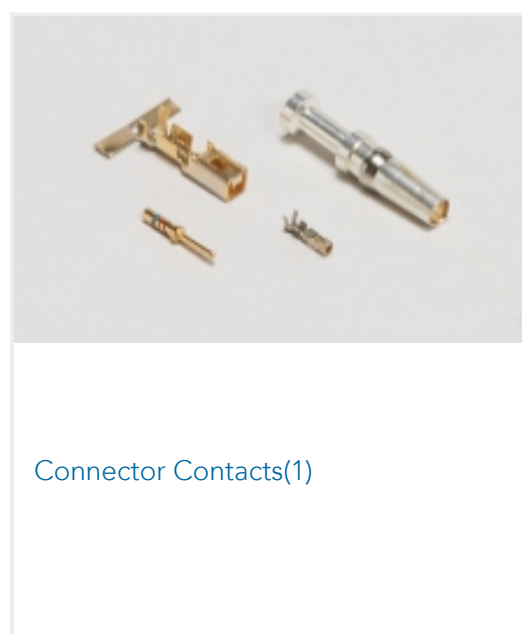

## Customers Also Bought

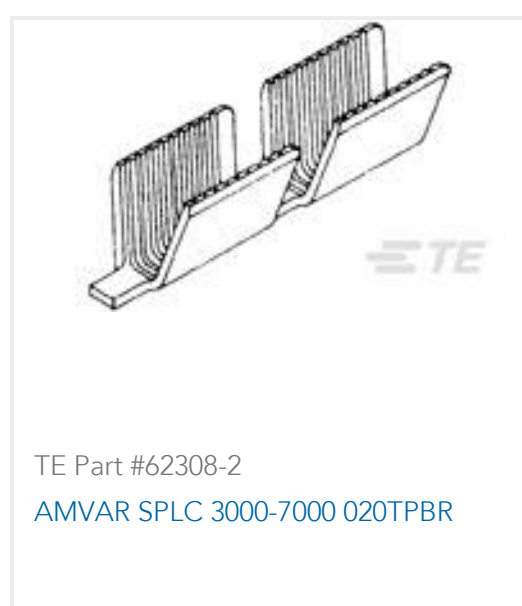

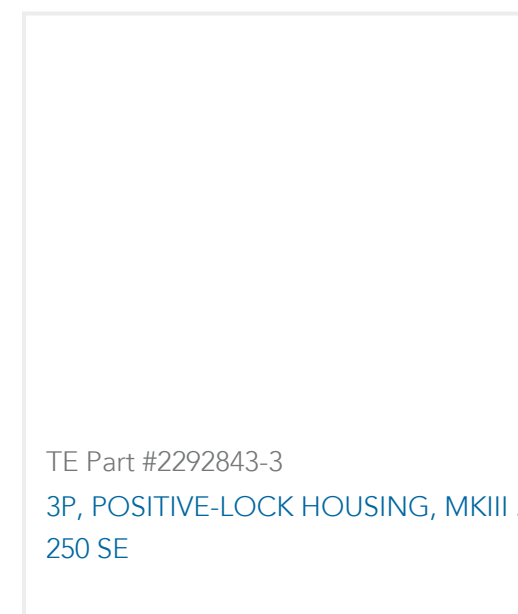

## Documents

### Product Drawings

[2P, RAST5 P-LOCK HSG, INNER SLOT](#)

English

### CAD Files

Customer View Model

[ENG\\_CVM\\_CVM\\_1-2371464-2\\_A1.2d\\_dxf.zip](#)

English

[3D PDF](#)

3D

Customer View Model

[ENG\\_CVM\\_CVM\\_1-2371464-2\\_A1.3d\\_stp.zip](#)

English

Customer View Model

[ENG\\_CVM\\_CVM\\_1-2371464-2\\_A1.3d\\_igs.zip](#)

English

By downloading the CAD file I accept and agree to the [Terms and Conditions](#) of use.

### Datasheets & Catalog Pages

[RAST Connector System Catalog](#)

English

### Product Specifications

[Product Specification](#)

English

### Agency Approvals

[UL Report](#)

English