

1-2348454-3 ✓ ACTIVE

[Dynamic Series](#) | [Dynamic 1000 Series](#)

TE Internal #: 1-2348454-3

PCB Mount Header, Vertical, Wire-to-Board, 6 Position, 2.5 mm [.099 in] Centerline, Fully Shrouded, Tin (Sn), Dynamic 1000 Series

[View on TE.com >](#)



Connectors > PCB Connectors > PCB Headers & Receptacles > Header Assembly: Wire-to-Board, 5A, gold or tin plated

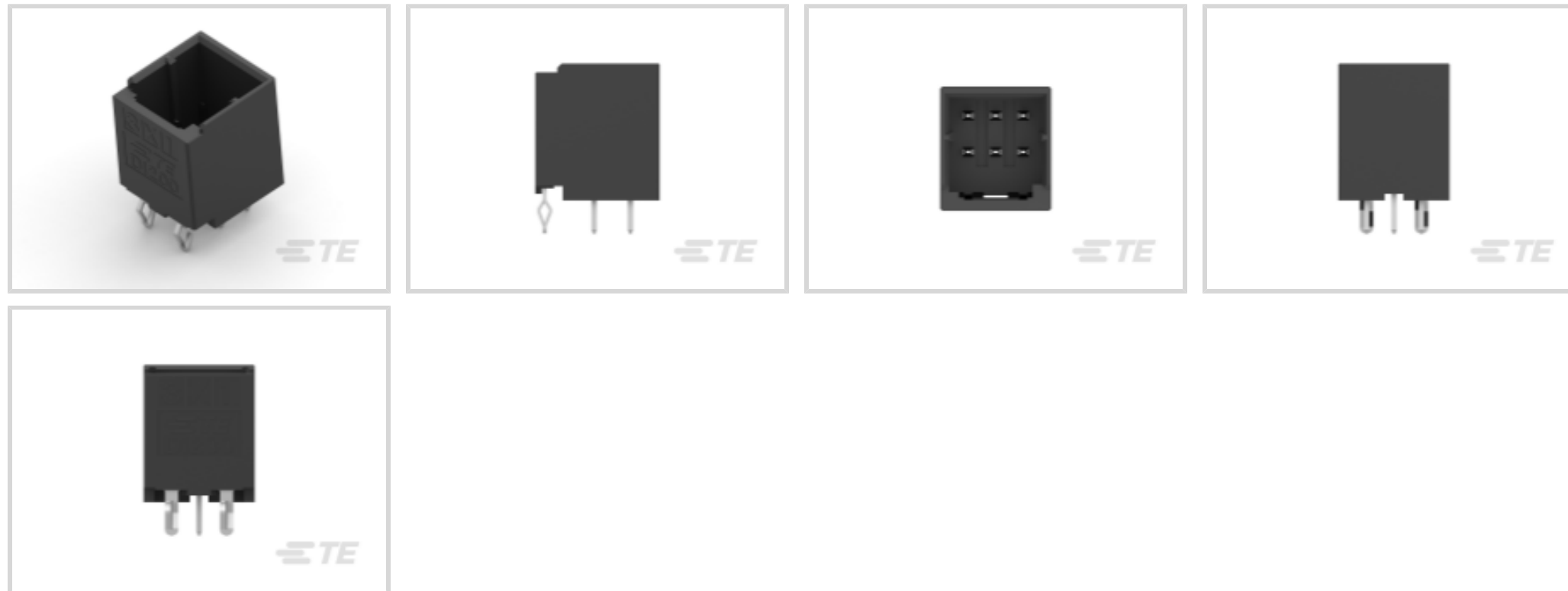

PCB Connector Type: **PCB Mount Header**

PCB Mount Orientation: **Vertical**

Connector System: **Wire-to-Board**

Number of Positions: **6**

Centerline (Pitch): **2.5 mm [.099 in]**

[All Header Assembly: Wire-to-Board, 5A, gold or tin plated \(89\)](#)

Features

Product Type Features

PCB Connector Type	PCB Mount Header
Connector System	Wire-to-Board
Header Type	Fully Shrouded
Sealable	No
Connector & Contact Terminates To	Printed Circuit Board
Connector Product Type	Connector Assembly

Configuration Features

PCB Mount Orientation	Vertical
Number of Positions	6
Number of Rows	2

Body Features

Primary Product Color	Black
-----------------------	-------

Contact Features



Contact Mating Area Plating Material	Tin (Sn)
Contact Mating Area Plating Material Finish	Matte
Contact Mating Area Plating Material Thickness	2 µm[80 µin]
Contact Type	Pin
Contact Current Rating (Max)	5 A

Termination Features

Termination Method to PCB	Through Hole - Solder
---------------------------	-----------------------

Mechanical Attachment

PCB Mount Retention Type	Retention Leg
Mating Alignment Type	Keyed
PCB Mount Alignment	Without
Mating Retention	With
PCB Mount Retention	With
Connector Mounting Type	Board Mount
Mating Alignment	With

Housing Features

Centerline (Pitch)	2.5 mm[.099 in]
Housing Material	Polyester GF

Usage Conditions

Operating Temperature Range	-55 – 105 °C[-67 – 221 °F]
-----------------------------	----------------------------

Operation/Application

Circuit Application	Power & Signal
---------------------	----------------

Industry Standards

UL Flammability Rating	UL 94V-0
------------------------	----------

Packaging Features

Packaging Method	Tube
------------------	------

Product Compliance

[For compliance documentation, visit the product page on TE.com>](#)

EU RoHS Directive 2011/65/EU	Compliant
EU ELV Directive 2000/53/EC	Compliant
China RoHS 2 Directive MIIT Order No 32, 2016	有害物质含量符合标准要求 No Restricted



	Substance(s) Above Threshold
EU REACH Regulation (EC) No. 1907/2006	Current ECHA Candidate List: JUNE 2025 (250) Candidate List Declared Against: JUNE 2025 (250) Does not contain REACH SVHC
Halogen Content	Not Low Halogen - contains Br or Cl > 900 ppm.
Solder Process Capability	Wave solder capable to 265°C

Product Compliance Disclaimer

This information is provided based on reasonable inquiry of our suppliers and represents our current actual knowledge based on the information they provided. This information is subject to change. The part numbers that TE has identified as EU RoHS compliant have a maximum concentration of 0.1% by weight in homogenous materials for lead, hexavalent chromium, mercury, PBB, PBDE, DBP, BBP, DEHP, DIBP, and 0.01% for cadmium, or qualify for an exemption to these limits as defined in the Annexes of Directive 2011/65/EU (RoHS2). Finished electrical and electronic equipment products will be CE marked as required by Directive 2011/65/EU. Components may not be CE marked. Additionally, the part numbers that TE has identified as EU ELV compliant have a maximum concentration of 0.1% by weight in homogenous materials for lead, hexavalent chromium, and mercury, and 0.01% for cadmium, or qualify for an exemption to these limits as defined in the Annexes of Directive 2000/53/EC (ELV). Regarding the REACH Regulation, the information TE provides on SVHC in articles for this part number is based on the latest European Chemicals Agency (ECHA) 'Guidance on requirements for substances in articles' posted at this URL: <https://echa.europa.eu/guidance-documents/guidance-on-reach>

Compatible Parts



Also in the Series | Dynamic 1000 Series

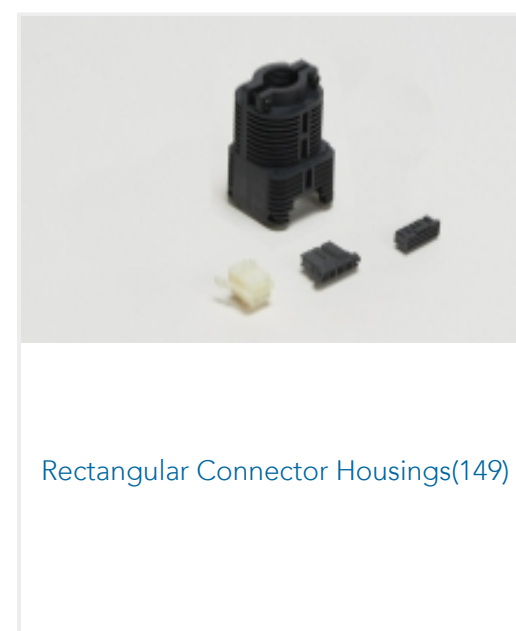
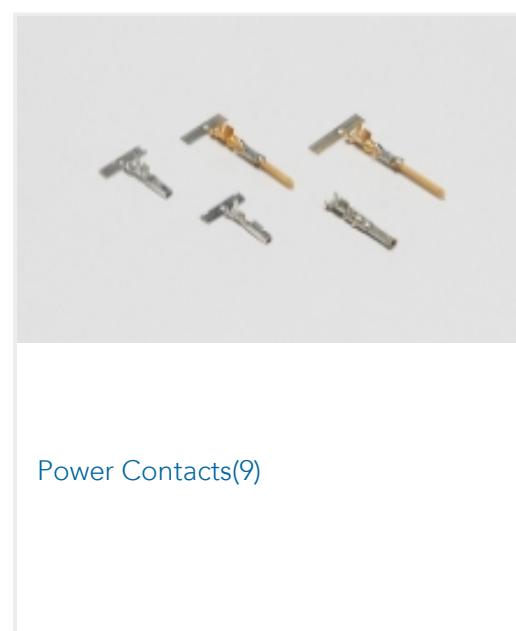
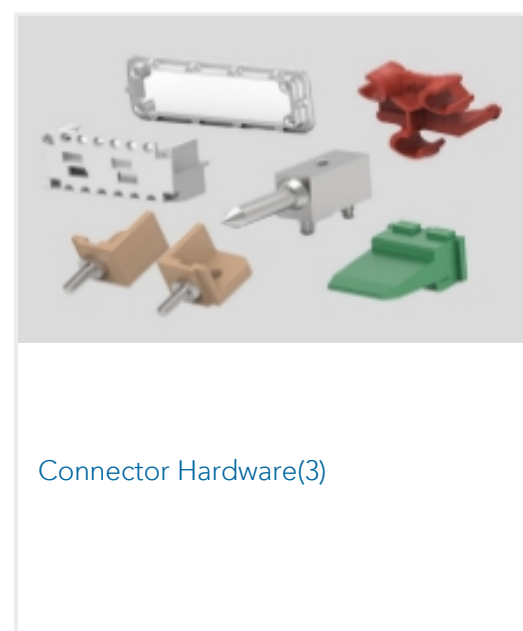
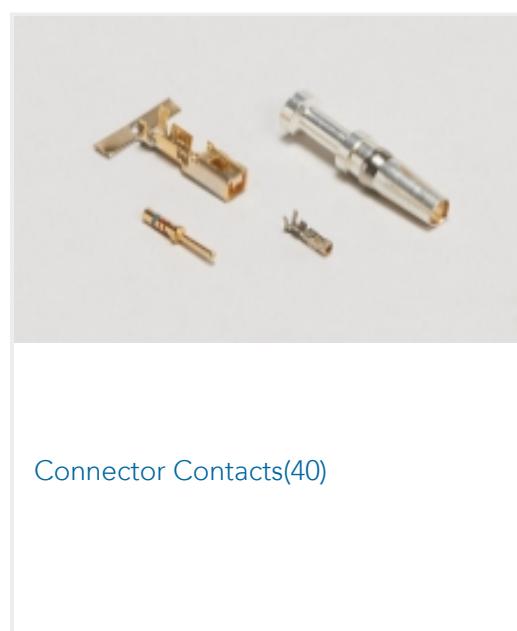



Rectangular Power Connectors(130)

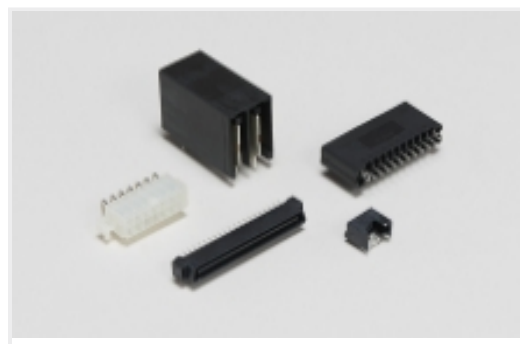

Standard Rectangular Connectors(152)

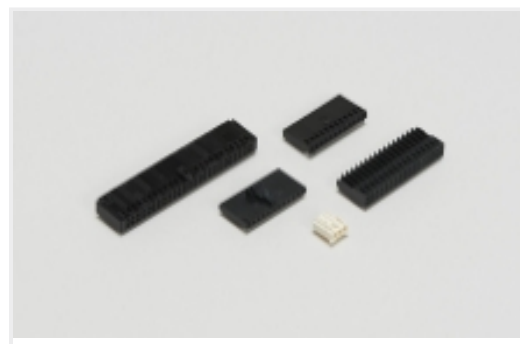

Wire-to-Board Connector Assemblies & Housings(84)

Customers Also Bought



TE Part #114017-ZZ
SEALING PLUG, SIZE 12/16, WHT



TE Part #DT04-2P
REC, 2P, GRY, N



TE Part #DT06-2S
PLG, 2P, GRY, N



TE Part #CAT-D48-ST273
DEUTSCH Connector Solid Contacts



TE Part #CAT-D487-W416
Wedgelocks: DEUTSCH DT

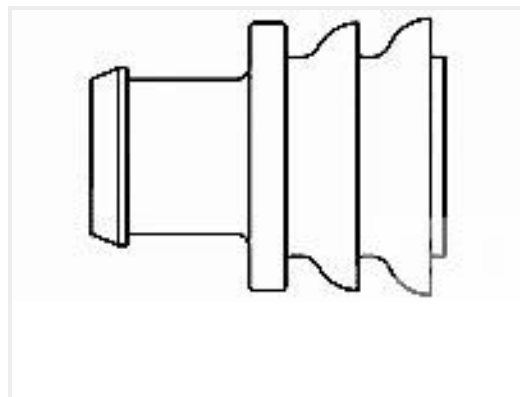

TE Part #281934-2
SINGLE WIRE SEAL



TE Part #CAT-AM71-CH8172
AMP SUPERSEAL 1.5MM,
CONNECTOR HOUSING

Documents

Product Drawings

DYNAMIC 1200D HDR ASSY V 6P X BLACK TIN

English

CAD Files

3D PDF

3D

Customer View Model

[ENG_CVM_CVM_1-2348454-3_A.2d_dxf.zip](#)

English

Customer View Model

[ENG_CVM_CVM_1-2348454-3_A.3d_igs.zip](#)

English

Customer View Model

[ENG_CVM_CVM_1-2348454-3_A.3d_stp.zip](#)

English

By downloading the CAD file I accept and agree to the [Terms and Conditions](#) of use.



Datasheets & Catalog Pages

DYNAMIC D-1000 SERIES

English

Product Specifications

Application Specification

English