

DF57 Series

Low Profile "Swing-Lock" Wire-to-Board Connector for Power (Compliant with UL, C-UL standards)



Power Supply



Positive-Lock



Low Profile



Apr. 1. 2026 Copyright 2026 HIROSE ELECTRIC CO., LTD. All Rights Reserved.



Features

1. Reinforced Lock Structure with Swing Lock

A swing-lock mechanism, featuring Hirose's proprietary connection method, reinforces the cable-side lock structure. This design is resistant to cable disengagement under load and supports challenging cable routing.

The connector also includes a guide surface for improved insertability. (Patented)

Swing-Lock Structure explanatory drawing

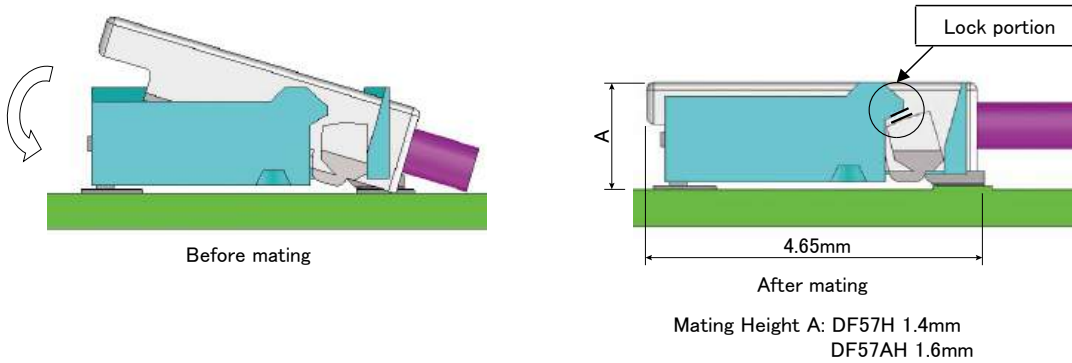

2. Header Lock Improves Plug Retention

The header connector is designed to retain the mold lance during engagement, preventing it from slipping and enhancing overall retention strength. (Patented)

3. Highly Reliable Contact Structure

Despite its low-profile design (1.4mm stacking height), the connector achieves an effective mating length of 0.42mm. A two-point contact structure ensures high contact reliability.

Contact Structure

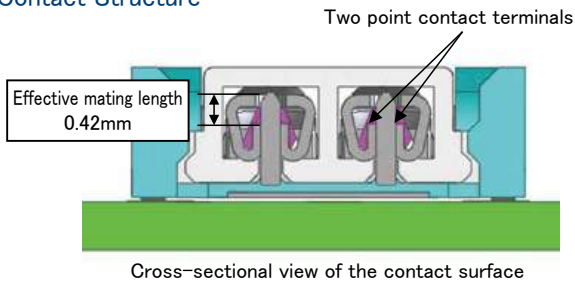

4. Insert Guide Key Prevents Misalignment

An insert guide key ensures correct mating alignment, improving operability and preventing potential connector breakage due to incorrect insertion.

【Incorrect Positioning】

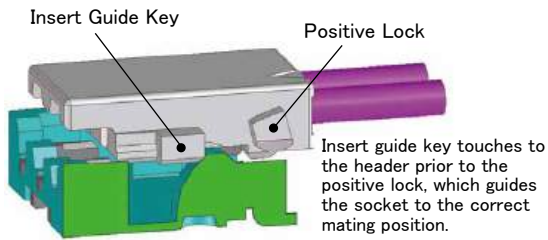

【Starts mating after the socket is aligned to the correct position】

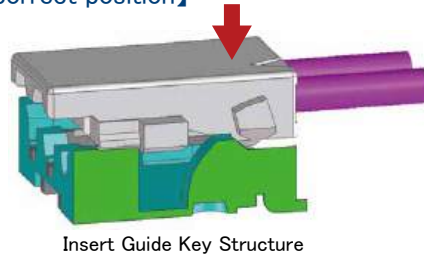

5. Solder Wicking Prevention

Integral molding eliminates gaps between terminals and housing, effectively preventing solder wicking.

6. Case Disengagement Prevention

Retention tabs are integrated in the molding, preventing the case from disengaging with the terminals due to tough electric cable routing and load.

7. Cost Effective

Integrating both terminals and retention tabs into the molding reduces assembly complexity and overall cost.

Specifications

	AWG	2pos.	3pos.	4pos.	5, 6pos.
Rated Current (Note 1)	26	3.0A/pin	-	1.5A/pin	1.5A/pin
	28	2.5A/pin	2.0A/pin	1.5A/pin	
	30	1.5A/pin		1.0A/pin	
	32	1.0A/pin		0.8A/pin	
	34	0.8A/pin		0.5A/pin	
	Rated Voltage	2 to 6pos.: 50V AC/DC 2pos. (Middle pin of 3 pos. is removed): 100V AC/DC			
Operating Temperature	-35 to +85°C (Note 2)				
Operating Humidity Range	20 to 80% (Note 3)				
Storage Temperature Range	-10 to +60°C (Note 4)				
Storage Humidity Range	40 to 70% (Note 4)				

	UL, C-UL certified specifications				
	AWG	2pos.	3pos.	4pos.	5, 6pos.
Rated Current (Note 1)	26	3.0A/pin	-	1.5A/pin	1.5A/pin
	28	2.5A/pin	2.0A/pin	1.5A/pin	
	30	1.5A/pin		1.0A/pin	
	32	1.0A/pin		0.8A/pin	
	34	0.8A/pin		0.5A/pin	
	Rated Voltage	2 to 6pos.: 29V AC/DC			

Note 1: This is the allowable current when the indicated current value is applied to all pins.

Note that the current may exceed the rated current when it is applied to multiple circuits.

Note 2: Includes temperature rise caused by current flow.

Note 3: Use without condensation.

Note 4: Storage here refers to the long-term storage condition for unused products before mounting the circuit board.

The operating temperature and humidity ranges are applied while in a non-energized state, while in transport or after PCB mounting.

Note 5: The above standards are representative of this series. Please refer to the "Delivery Specifications" for proper exchange.

Item	Specification	Condition
Insulation Resistance	100M Ω Min.	100V DC
Withstanding Voltage	No insulation breakdown.	500V AC for 1 min.
Contact Resistance	10m Ω Max.	Measured at 20 mV AC or less 1mA
Vibration Resistance	No electrical discontinuity of 1 μ s or more	Frequency: 10 to 55Hz, Single Amplitude: 0.75mm, 10 cycles each in 3 axes.
Shock Resistance	No electrical discontinuity of 1 μ s or more	Acceleration: 490m/s ² Duration: 11ms, half-sine waves 3 times each in both directions
Humidity	Contact Resistance: 20m Ω Max. Insulation Resistance: 500M Ω Min.	Temperature: 40 ± 2°C Humidity: 90 to 95%, Leave for 96 hours
Temperature Cycle	Contact Resistance: 20m Ω Max. Insulation Resistance: 500M Ω Min.	Temperature: -55 → +5 to +35 → +85 → +5 to +35°C Time: 30 → 2 to 3 → 30 → 2 to 3 minutes 5 cycles
Mating Durability	Contact Resistance: 20m Ω Max.	30 times
Resistance to Soldering Heat	No melting of the resin part that affects the performance.	Reflow: Recommended Temperature Profile Manual soldering: 350 ± 10°C for 3 seconds

Material / Finish

Product	Parts	Material	Color / Finish	UL Flammability Rating	RoHS2
Header	Insulation	LCP	Black	UL94V-0	○
			Beige		
	Contact	Brass	Tin Plated or Gold Plated	-	○
Crimp Socket	Insulation	PBT	White	UL94V-0	○
			Black		
		LCP	Beige		
			Black		
Crimp Contacts	Contact	Phosphor Bronze	Tin Plated or Gold Plated	-	○

Product Number Structure

Refer to the chart below when determining the product specifications from the product number.
Please select from the product numbers listed in this catalog when placing orders.

■ Header

● 1.2mm Pitch

DF57 H - # P - 1.2 V

① ② ③ ④ ⑤ ⑥

① Series Name	DF57	④ Connector Type	P: Plug
② Insertion Guide Key	H: Yes	⑤ Contact Pitch	1.2mm
③ No. of Pos.	2, 3, 4, 5, 6	⑥ Connection Part	V: SMT Straight Type

● 2.4mm Pitch

DF57 H - 2 P - 2.4 V

① ② ③ ④ ⑤ ⑥

① Series Name	DF57	④ Connector Type	P: Plug
② Insertion Guide Key	H: Yes	⑤ Contact Pitch	2.4mm (3 pos. with middle pin out: product corresponding to rated voltage 100V)
③ No. of Pos.	2	⑥ Connection Part	V: SMT Straight Type

■ Socket

● Applicable Cable Size 28 to 34 AWG

DF57 # H - # S - 1.2 C

① ② ③ ④ ⑤ ⑥ ⑦

① Series Name	DF57	⑤ Connector Type	S: Crimp Socket
② Applicable Cable Size	None: 28 to 34 AWG	⑥ Contact Pitch	1.2mm
③ Insertion Guide Key	H: Yes	⑦ Connection Part	C: Crimp Socket
④ No. of Pos.	2, 3, 4, 5, 6		

● Applicable Cable Size 26 to 28 AWG

DF57 A H - # S - 1.2 C

① ② ③ ④ ⑤ ⑥ ⑦

① Series Name	DF57	⑤ Connector Type	S: Crimp Socket
② Applicable Cable Size	A: 26 to 28 AWG	⑥ Contact Pitch	1.2mm
③ Insertion Guide Key	H: Yes	⑦ Connection Part	C: Crimp Socket
④ No. of Pos.	2, 4, 5, 6		

■ Crimp Contact

DF57 - 2830 SCF A

① ② ③ ⑤

① Series Name	DF57	③ Type / Packaging Type	SCF: Socket Contact / Reel
② Applicable Cable Size	2628: 26 to 28 AWG 2830: 28 to 30 AWG 3234: 32 to 34 AWG	④ Plating Specifications	None: Tin Plated A: Gold Plated

Straight Pin Header, SMT

● 1.2mm Pitch

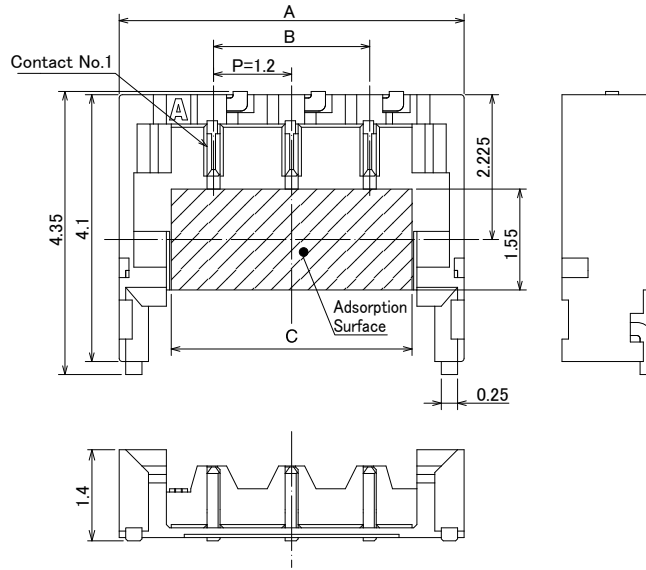

Recommended PCB Layout (t=1mm)

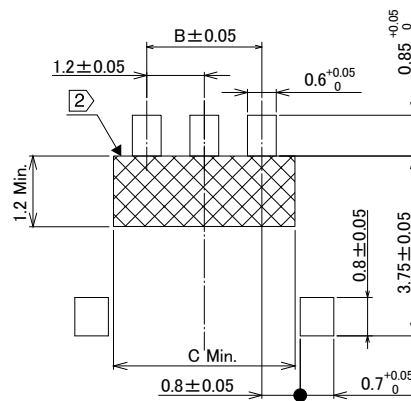

Unit : mm

Part No.	HRS No.	No. of Pos.	A	B	C	Specification No. (Note 2)			Purchase Unit
						(21)	(23)	(51)	
DF57H-2P-1.2V(##)	CL0666-0104-7-##	2	4.1	1.2	2.5	○	○	○	5,000pcs per reel
DF57H-3P-1.2V(##)	CL0666-0105-0-##	3	5.3	2.4	3.7	○	○		
DF57H-4P-1.2V(##)	CL0666-0106-2-##	4	6.5	3.6	4.9	○	○	○	
DF57H-5P-1.2V(##)	CL0666-0107-5-##	5	7.7	4.8	6.1	○			
DF57H-6P-1.2V(##)	CL0666-0108-8-##	6	8.9	6	7.3	○			

[Specifications] -##, (##)
 (21): Tin Plated, Color: Black
 (23): Tin Plated, Color: Beige
 (51): Gold Plated, Color: Black

Note 1: If there is a pattern on the area and resist is not applied, it may come into contact with the connector terminal.
 Note 2: For products for which "○" is not indicated in the specification number column, contact a Hirose sales representative.

● 2.4mm Pitch

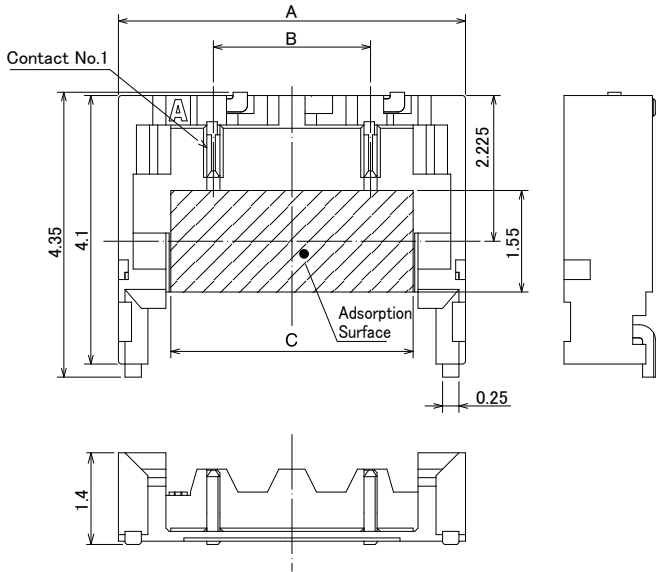

Recommended PCB Layout (t=1 mm)

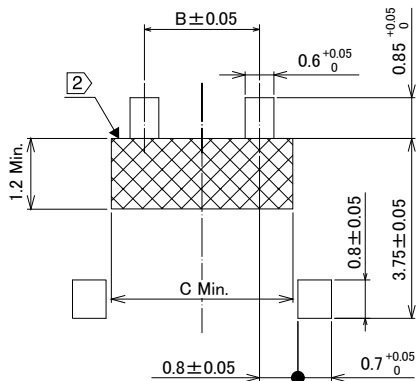

Note: If there is a pattern on the area and resist is not applied, it may come into contact with the connector terminal.

Unit : mm

Part No.	HRS No.	No. of Pos.	A	B	C	Specification No.		Purchase Unit
						(21)	(23)	
DF57H-2P-2.4V(##)	CL0666-0109-0-##	2	5.4	2.4	3.7	○	○	5,000pcs per reel

[Specifications] -##, (##)
 (21): Tin Plated, Color: Black
 (23): Tin Plated, Color: Beige

Crimp Socket

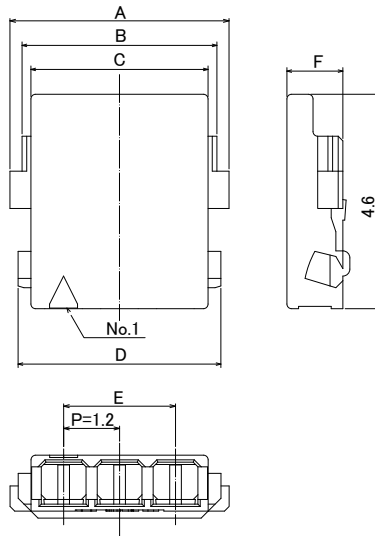

Unit : mm

Part No.	HRS No.	No. of Pos.	A	B	C	D	E	F	Specification No.			Purchase Unit
									None	(08)	(15)	
DF57H-2S-1.2C(##)	CL0666-0100-6-##	2	3.5	2.98	2.6	3.2	1.2	1.2	○	○	○	1,000pcs per bag
DF57H-3S-1.2C(##)	CL0666-0012-0-##	3	4.7	4.18	3.8	4.4	2.4	1.2	○	○	○	
DF57H-4S-1.2C(##)	CL0666-0101-9-##	4	5.9	5.38	5.0	5.6	3.6	1.2	○	○	○	
DF57H-5S-1.2C(##)	CL0666-0102-1-##	5	7.1	6.58	6.2	6.8	4.8	1.2	○	○	○	
DF57H-6S-1.2C(##)	CL0666-0103-4-##	6	8.3	7.78	7.4	8.0	6.0	1.2	○	○	○	

[Specifications] -##, (##)
 None: Material: PBT, Color: White
 (08): Material: LCP, Color: Beige
 (15): Material: LCP, Color: Black

26 AWG Applicable Connector

Unit : mm

Part No.	HRS No.	No. of Pos.	A	B	C	D	E	F	Specification No. (Note 2)			Purchase Unit
									None	(10)	(15)	
DF57AH-2S-1.2C(##)	CL0666-0112-0-##	2	3.5	2.98	2.6	3.2	1.2	1.4	○		○	1,000pcs per bag
DF57AH-4S-1.2C(##)	CL0666-0113-0-##	4	5.9	5.4	5.0	5.6	3.6	1.4	○			
DF57AH-5S-1.2C(##)	CL0666-0110-0-##	5	7.1	6.6	6.2	6.8	4.8	1.4	○			
DF57AH-6S-1.2C(##)	CL0666-0111-2-##	6	8.3	7.8	7.4	8.0	6.0	1.4	○	○		

[Specifications] -##, (##)
 None: Material: PBT, Color: Black
 (10): Material: PBT, Color: White
 (15): Material: LCP, Color: Black

Note: For products without "○" in the specification number column, please contact a Hirose sales representative.

Crimp Contact

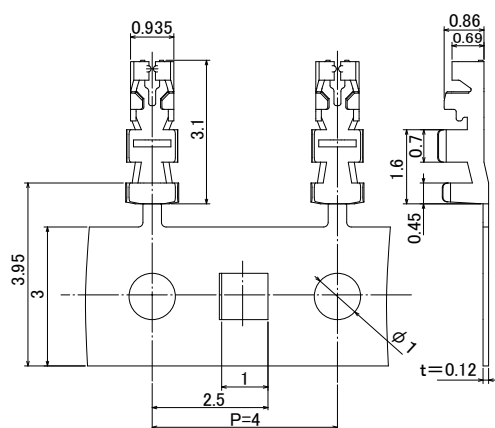

Strip Length: 1.0 to 1.4mm

Part No.	HRS No.	Finish	Applicable Cable	Applicable Socket Connector	Purchase Unit
DF57-2628SCF(41)	CL0666-0013-3-41	Tin Plated	26 to 28 AWG	DF57AH-#S-1.2C(##)	35,000pcs per reel
DF57-2628SCFA(41)	CL0666-0033-0-41	Gold Plated			
DF57-2830SCF	CL0666-0001-4-00	Tin Plated	28 to 30 AWG	DF57H-#S-1.2C(##)	40,000pcs per reel
DF57-2830SCFA	CL0666-0034-3-00	Gold Plated			
DF57-3234SCF	CL0666-0016-1-00	Tin Plated	32 to 34 AWG		

Applicable Cable (Tin Plated Soft Copper Cable)

Part No.	Conductor Size (Core Wire Configuration)	Jacket Diameter	Recommended Wire
DF57-2628SCF(41) DF57-2628SCFA(41)	26 AWG (7 / ϕ 0.16mm)	ϕ 0.88mm Max.	UL3610
	28 AWG (7 / ϕ 0.127mm)		UL1061
DF57-2830SCF DF57-2830SCFA	28 AWG (7 / ϕ 0.127mm)	ϕ 0.5 to ϕ 0.63mm	UL1571 (Thin Wire), UL10584 (ETFE Wire)
	30 AWG (7 / ϕ 0.102mm)		
DF57-3234SCF	32 AWG (7 / ϕ 0.08mm)	ϕ 0.32 to ϕ 0.54mm	UL1571
	34 AWG (Note 2)		-

Note 1: For conforming wires other than the above, refer to the crimping condition table. The crimping condition table is available from the link of the product number. (If you are using an electric wire that is not listed in the crimping condition table, please contact a Hirose sales representative.)

Note 2: When using 34 AWG, contact a Hirose sales representative.

Packaging Specifications

- DF57H-2P-1.2V(##)
- DF57H-3P-1.2V(##)
- DF57H-2P-2.4V(##)

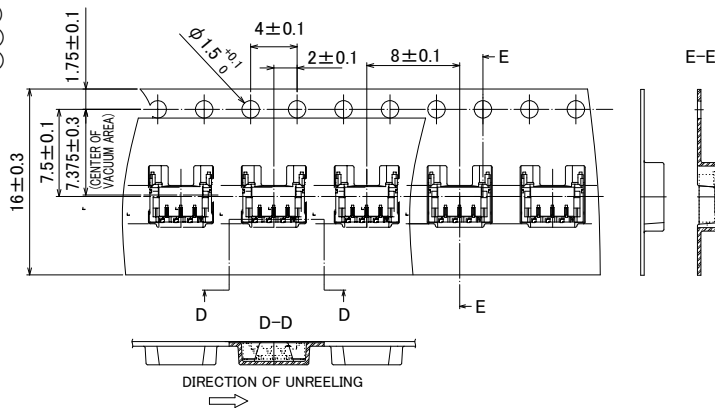

- DF57H-4P-1.2V(##)
- DF57H-5P-1.2V(##)
- DF57H-6P-1.2V(##)

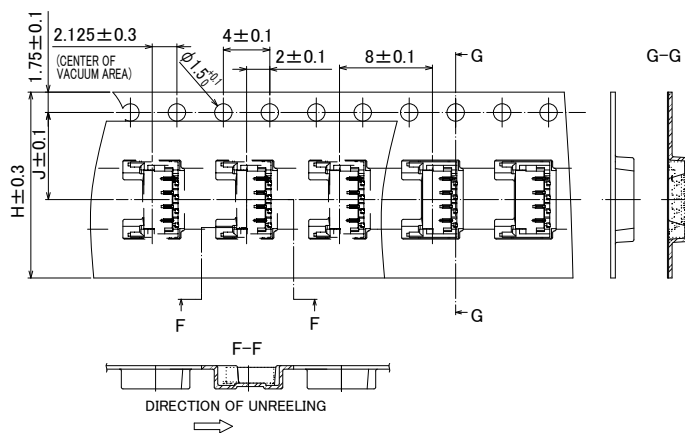

Unit : mm

Part No.	No. of Pos.	H	J
DF57H-4P-1.2V(##)	4	16	7.5
DF57H-5P-1.2V(##)	5	16	7.5
DF57H-6P-1.2V(##)	6	24	11.5

Applicable Crimping Tool

Type	Part No.	HRS No.	Applicable Contacts
Applicator	AP105-DF57-2628S	CL0901-4622-2-00	DF57-2628SCF(41) DF57-2628SCFA(41)
	AP105-DF57-2830S	CL0901-4618-5-00	DF57-2830SCF
	AP105-DF57-2830SA	CL0901-4645-0-00	DF57-2830SCFA
	AP105-DF57-3234S	CL0901-4629-1-00	DF57-3234SCF
Press Body	CM-105C	CL0901-0001-0-00	-
Hand Tool	HT305/DF57-2830HC (Note 2)	CL0902-4635-0-00	DF57-2830SCF
Extraction Tool	DF-C-PO(B)	CL0550-0179-2-00	DF57-####SCF(A)

Note 1: Crimping work must be performed in accordance with the Crimping Quality Standards and Crimping Conditions Table.

Note 2: When using hand tools, only UL1571 thin wire type (28 to 30 AWG) is used.

Note 3: Problems caused by tools other than those specified by our company are not covered by the warranty.

Note 4: If you do not use a tool specified by our company, please contact a Hirose sales representative to request dies drawing.

Crimping Precautions

■ Items Required Prior to Starting

The work-related documents shown below are required before starting harness assembly.
(The ● mark shows the document required.)

When the documents shown below are not available, ask a Hirose sales representative to provide them.

Document Title	Description	Automatic Crimping Machine	Hand Crimping Tool	Remarks
① Crimping Machine Main Unit Instruction Manual	Explanation of main press machine unit	●	—	Bundled with purchase of main press machine unit.
② Applicator Spare Parts Identification	Explanation for Applicator installation	●	—	Bundled with purchase of applicator.
③ Crimp Conditions	Standard values of: Crimp height, Tensile strength	●	—	
④ Crimp Quality Standards	Various standards for crimping conditions	●	—	
⑤ Operating Instructions for Hand Tool	Inspection items of: Crimp height, Tensile strength, and others	—	●	Bundled with purchase of hand tool.
⑥ Cable Assembly Instruction	Harness Procedure	●	●	Please refer to our website.

Tools

When crimping work is applied to our contacts, use the tools designated by Hirose.

*Crimping performed with tools other than those designated should be avoided as it may result in contact failure, disconnection of cable, etc.

*The operating instructions manual is available for the crimping machine and the applicator.

Be sure to carefully read the operating instructions manual before beginning work.

Applicable Cables

Refer to Crimp Condition Table when using cables other than applicable wire. Crimp Condition Table is available from Part No. link.

(If you are using a cable that is not listed in Crimp Condition Table, please contact a Hirose sales representative.)

[Precautions]

- Cables applicable to crimping connectors are tin-plated stranded soft copper wire.
- Avoid crimping solid wire, wires with polyester threads or tin coated wires.
- Avoid crimping two cables together.
- The crimp height setting values (Note) may vary between tin-plated and gold-plated contacts even if the same electric wires are used.
- The crimp height setting values (Note) may vary depending on the difference in the core wire configuration even if the computed cross-sectional area is the same.

Note: The crimp height is an important item that determines crimping quality.

We execute crimping tests for each electric wire to ensure the optimal value for the crimp height with high precision, thereby ensuring optimal setup values.

Precautions

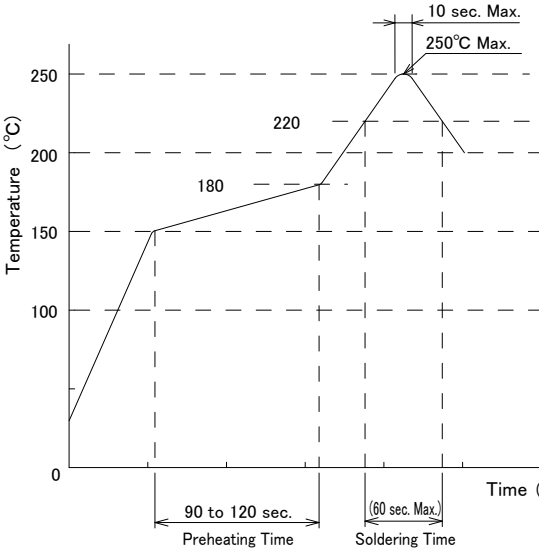
<p>1. Recommended Temperature Profile (Lead-Free Mounting)</p>	 <p>【Conditions】</p> <ol style="list-style-type: none"> 1. Peak Temperature: 250°C Max. 2. Heating: 220°C Min., within 60 sec. 3. Preheating: 150 to 180°C, 90 to 120 sec. 4. Number of Reflow Cycles: 2 cycles Max. <p>* Temperature refers to the surface temperature of the board near the connector lead. Soldering results may change depending on the conditions such as solder paste types, manufacturer, PCB size, and other soldering materials, so please fully check the mounting conditions before use. Note: This temperature profile is a recommended value.</p>
<p>2. Recommended manual soldering</p>	<p>Soldering iron temperature: 350 ± 10°C, Soldering Time: Within 3 sec.</p>
<p>3. Recommended Metal Mask Thickness and Open Area to PCB Pattern (Area Ratio)</p>	<p>Thickness: 0.1mm, Aperture Ratio: 100%</p>
<p>4. Board warpage</p>	<p>Max. of 0.02mm at the center in reference to both ends of the connector.</p>
<p>5. Cleaning Conditions</p>	<p>Please refer to the "Product Guidelines (Board-to-Wire Connector Guidelines)". IPA cleaning is possible. (Washing may change the feel of insertion and removal, so washing is not recommended. Please contact us if you want to use other cleaning solutions)</p>
<p>6. Cautions</p>	<ul style="list-style-type: none"> ■ When inserting the crimping terminal into the crimping socket, to maintain performance reliability, insert crimped terminals horizontally. Avoid inserting them at an angle. ■ Refer to the separate "Cable Assembly Instruction for DF57 Series" and "Crimping Condition Table" for handling precautions when harnessing. ■ Please note that inserting/removing the terminal while the board is not mounted can cause damage or deformation of the terminal. ■ Please note that removing the terminal while holding the wire can cause damage. ■ When soldering by hand, do not apply flux that may result in flux rising. ■ Depending on the production lot of this product, there may be slight differences in the hue of the molded product. This does not affect product performance. In addition, black spots may appear on the molded resin, but this does not affect the quality of the product.
<p>7. Handling Instructions</p>	<p>Please refer to the materials listed below on our company website when handling this product.</p> <ul style="list-style-type: none"> ■ Crimp Quality Standard ■ Cable Assembly Instruction ■ Product Guidelines (Mating/Unmating Operation Instruction Manual) ■ Product Guidelines (Procedures for Using the Crimp Terminal Extracting Tool) ■ Product Guidelines (Board-to-Wire Connector Guidelines)

Operation Precautions

【Mating Operation】

- ① Determine position, fitting the external form.

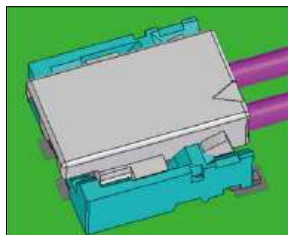

- ② Insert the cable side.

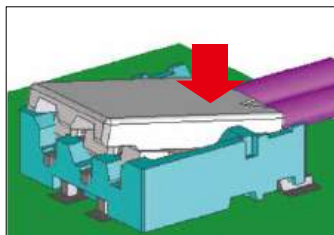

- ③ Press down at the lever side.

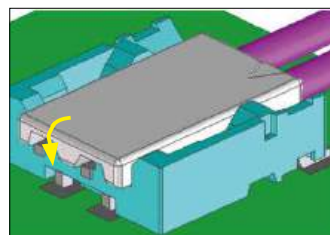

【Unmating Operation】

- ① Hook the lever.



- ② Pull up and friction lock is released.

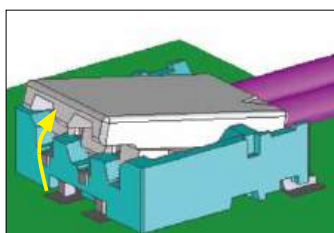

- ③ Positive lock is released, and removal completes.

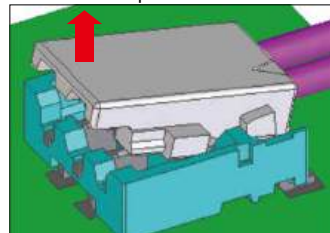

While Taking into Consideration

Specifications mentioned in this catalog are reference values.

When considering to order or use this product, please review the Drawing and Product Specifications sheets.

Use an appropriate cable when using the connector in combination with cables.

If considering usage of a non-specified cable, please contact your sales representative.

If assembly process is done by jigs & tools which are not identified by Hirose, the warranty of the product may be affected.

If considering usage for below mentioned applications, please contact your sales representative.

In cases where the application will demand a high level of reliability, such as automotive, medical instruments, public infrastructure, aerospace/defense etc. Hirose must review before assurance of reliability can be given.