

Smart Sensor 2D Measurement Type ZS

CSM_ZS_DS_E_6_5

A Lineup for Ultra-high-precision Displacement Measurements That Take Smart Sensors into a New Realm



- **ZS-HL Series**
Ultra-high-performance Sensors for core quality for everything from ultra-long ranges to ultra-high precision.
- **ZS-L Series**
Standard Sensors that are ideal for a wide range of high-precision displacement measurements, including spot detection, wide-area detection, and long-distance detection.



Note: Orders for ZS-HLDS2T and ZS-LD40T 4M will be accepted until the end of August 2019.

For the most recent information on models that have been certified for safety standards, refer to your OMRON website.

Be sure to read "Safety Precautions" on page 22.

System Configuration

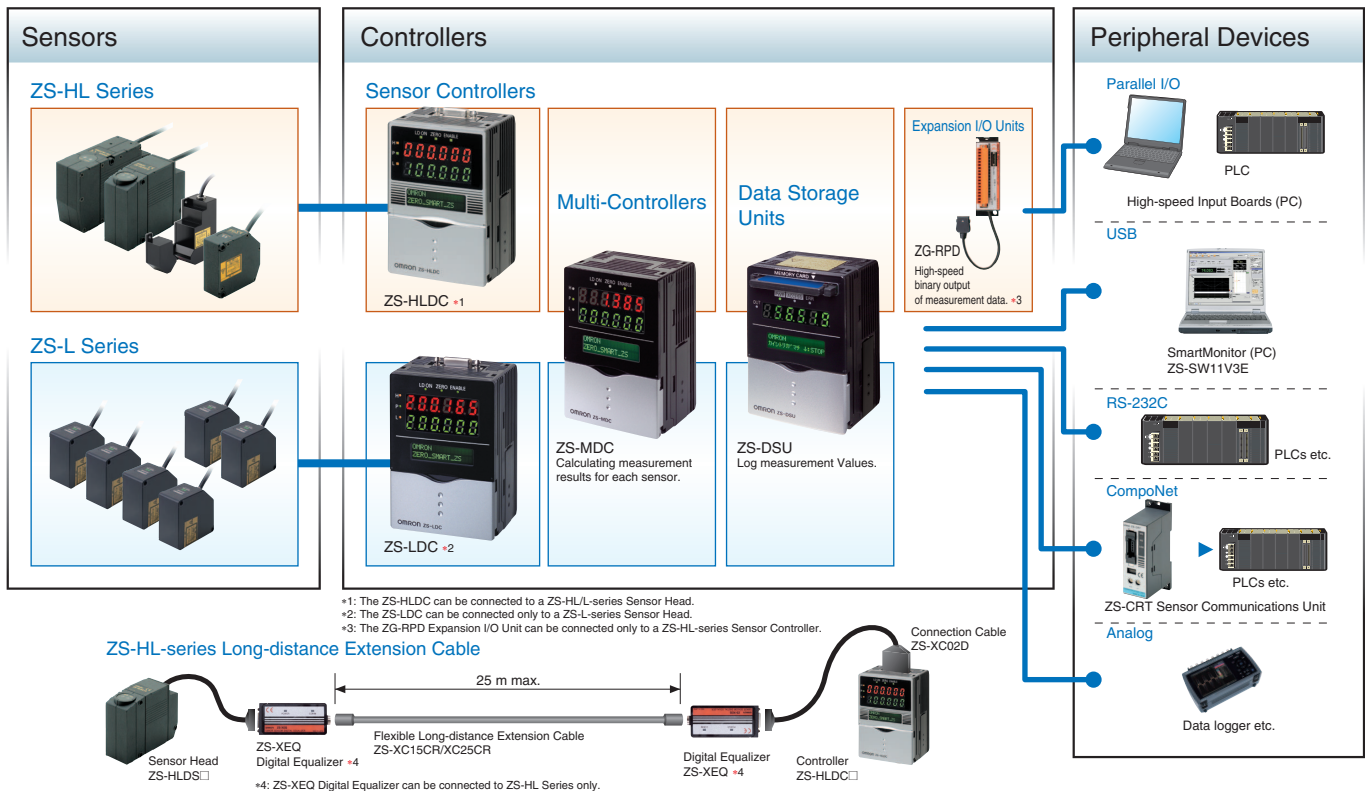

Ordering Information

Smart Sensor

ZS-HL-series Sensor Heads

Optical system	Sensing distance	Beam shape	Beam diameter	Resolution (see note)	Cable length	Model
Regular Reflective Models	20±1 mm	Line beam	1.0 mm × 20 μm	0.25 μm	2m	ZS-HLDS2T 2M *
					0.5m	ZS-HLDS2T 0.5M *
	25±2 mm	Line beam	2.2 mm × 45 μm	0.6 μm	2m	ZS-HLDS2VT 2M
					0.5m	ZS-HLDS2VT 0.5M
Diffuse Reflective Models	50±5 mm	Line beam	1.0 mm × 0 μm	0.25 μm	2m	ZS-HLDS5T 2M
					0.5m	ZS-HLDS5T 0.5M
	100±20 mm	Line beam	3.5 mm × 60 μm	1 μm	2m	ZS-HLDS10 2M
					0.5m	ZS-HLDS10 0.5M
	600±350 mm	Line beam	16 mm × 0.3 mm	8 μm	2m	ZS-HLDS60 2M
					0.5m	ZS-HLDS60 0.5M
	1500±500 mm	Line beam	40 mm × 1.5 mm	500 μm	2m	ZS-HLDS150 2M
					0.5m	ZS-HLDS150 0.5M

Note: Refer to the table of ratings and specifications for details.

* Orders will be accepted until the end of August 2019.

ZS-HL-series Sensor Heads (For Nozzle Gaps)

Optical system	Sensing distance	Beam shape	Beam diameter	Resolution (see note)	Cable length	Model
Regular Reflective Models	10±0.5 mm	Line beam	900 × 25 μm	0.25 μm	2m	ZS-LD10GT 2M
					0.5m	ZS-LD10GT 0.5M
	15±0.75 mm	Line beam	900 × 25 μm	0.25 μm	2m	ZS-LD15GT 2M
					0.5m	ZS-LD15GT 0.5M

Note: Refer to the table of ratings and specifications for details.

ZS-L-series Sensor Heads

Optical system	Sensing distance	Beam shape	Beam diameter	Resolution (see note)	Cable length	Model
Regular Reflective Models	20±1 mm	Line beam	900 × 25 μm	0.25 μm	2m	ZS-LD20T 2M
		0.5m	ZS-LD20T 0.5M			
	Spot beam	25 μm dia.	0.25 μm	2m	ZS-LD20ST 2M	
				0.5m	ZS-LD20ST 0.5M	
	40±2.5 mm	Line beam	2000 × 35 μm	0.4 μm	4m	ZS-LD40T 4M *
					2m	ZS-LD40T 2M
0.5m	ZS-LD40T 0.5M					
Diffuse Reflective Models	50±5 mm	Line beam	900 × 60 μm	0.8 μm	2m	ZS-LD50 2M
					0.5m	ZS-LD50 0.5M
		Spot beam	50 μm dia.	0.8 μm	2m	ZS-LD50S 2M
					0.5m	ZS-LD50S 0.5M
	80±15 mm	Line beam	900 × 60 μm	2 μm	2m	ZS-LD80 2M
					1m	ZS-LD80 1M
		0.5m	ZS-LD80 0.5M			
			130±15 mm	Line beam	600 × 70 μm	3 μm
	0.5m	ZS-LD130 0.5M				
	200±50 mm	Line beam	900 × 100 μm	5 μm	2m	ZS-LD200 2M
					0.5m	ZS-LD200 0.5M
	350±135 mm	Spot beam	240 μm dia.	20 μm	2m	ZS-LD350S 2M
0.5m					ZS-LD350S 0.5M	

Note: No. of samples to average: 128 when set to High-precision Mode.

* Orders will be accepted until the end of August 2019.

ZS-HL-series Sensor Controllers

Shape	Supply voltage	Control outputs	Model
	24 VDC	NPN outputs	ZS-HLDC11
		PNP outputs	ZS-HLDC41

Multi-Controllers

Shape	Supply voltage	Control outputs	Model
	24 VDC	NPN outputs	ZS-MDC11
		PNP outputs	ZS-MDC41

ZS-L-series Sensor Controllers

Shape	Supply voltage	Control outputs	Model
	24 VDC	NPN outputs	ZS-LDC11
		PNP outputs	ZS-LDC41

Data Storage Units



Shape	Supply voltage	Control outputs	Model
	24 VDC	NPN outputs	ZS-DSU11
		PNP outputs	ZS-DSU41

Accessories (Sold Separately)

Controller Link Unit

Shape	Model
	ZS-XCN

Panel Mount Adapter

Shape	Model	
	ZS-XPM1	For 1st Controller
	ZS-XPM2	For expansion (from 2nd Controller on)

RS-232C Cables

Connected to	Model	Qty
Personal computer (2 m)	ZS-XRS3	1
PLC/PT (2 m)	ZS-XPT3	

Extension Cables for Sensor Heads

Cable length	Model	Qty
1 m	ZS-XC1A	1
4 m	ZS-XC4A	
5 m	ZS-XC5B (*1,*2)	
8 m	ZS-XC8A	
10 m	ZS-XC10B (*1)	

*1 Up to two ZS-XC□B Cables can be connected. (22 m max.)

*2 The ZS-XC3BR (3 m) and ZS-XC5BR (5 m) Robot Cables are also available.

Long Extension Cables for Sensor Heads (Used with a Digital Equalizer for ZS-HL Series)

Name	Model	Qty
Digital Equalizer (Relay)	ZS-XEQ	1
Extension Cable (long distance, flexible 15 m cable)	ZS-XC15CR	1
Extension Cable (long distance, flexible 25 m cable)	ZS-XC25CR	1
Digital Equalizer Connection Cable (0.2 m)	ZS-XC02D	1

Logging Software

Name	Model
SmartMonitor Professional	ZS-SW11V3E

Realtime Parallel Output Unit (for ZS-HL Series)

Shape	Control outputs	Model
	NPN outputs	ZG-RPD11-N
	PNP outputs	ZG-RPD41-N

CompoNet-compatible Sensor Communications Unit

Shape	Model
	ZS-CRT

Memory Cards

Model	Capacity
HMC-EF283	256 MB
HMC-EF583	512 MB

Quick Reference for Extension Cable Connections

Extension Cable			Sensor Head			Controller		Remarks
Model	Length	Bend resistant	ZS-LD□ ZS-HLDS2V	ZS-HLDS2/ -HLDS5/-HLDS10/ -HLDS60/-HLDS150	ZS-LDC□	ZS-HLDC□		
ZS-XC1A	1m		○	○	○	○	Only one Extension Cable can be used.	
ZS-XC4A	4m		○	○	○	○		
ZS-XC8A	8m		○	○	○	○		
ZS-XC5B	5m		○	○	○	○	Up to two Extension Cables can be used. (The maximum length is 22 m.)	
ZS-XC10B	10m		○	○	○	○		
ZS-XC5BR	5m	○	○	○	○	○	A ZS-XEQ Digital Equalizer and ZS-XC02D Digital Equalizer Connecting Cable are required.	
ZS-XC15CR	15m	○		○		○		
ZS-XC25CR	25m	○		○		○		

Ratings and Specifications

ZS-HL/L-series Sensor Controllers

Item	Model	ZS-HLDC11/LDC11	ZS-HLDC41/LDC41	
No. of samples to average		1, 2, 4, 8, 16, 32, 64, 128, 256, 512, 1,024, 2,048, or 4,096		
Number of mounted Sensors		1 per Sensor Controller		
External interface	Connection method		Serial I/O: connector, Other: pre-wired (Standard cable length: 2 m)	
	Serial I/O	USB 2.0	1 port, Full Speed (12 Mbps max.), MINI-B	
		RS-232C	1 port, 115,200 bps max.	
	Output	Judgment output	HIGH/PASS/LOW 3 outputs NPN open collector, 30 VDC, 50 mA max., residual voltage 1.2 V max.	HIGH/PASS/LOW: 3 outputs PNP open collector, 50 mA max., residual voltage 1.2 V max.
		Linear output	Selectable from 2 types of output, voltage or current (selected by slide switch on bottom). <ul style="list-style-type: none"> Voltage output: -10 to 10 V, output impedance: 40 Current output: 4 to 20 mA, maximum load resistance: 300 	
Inputs	Laser OFF, ZERO reset timing, RESET	ON: Short-circuited with 0 V terminal or 1.5 V or less OFF: Open (leakage current: 0.1 mA max.)	ON: Short-circuited to supply voltage or within 1.5 V of supply voltage. OFF: Open (leakage current: 0.1 mA max.)	
Functions		<p>Display: Measured value, threshold value, voltage/current, received light amount, and resolution/terminal block output *2</p> <p>Sensing: Mode, gain, measurement object, head installation</p> <p>Measurement point *1: Average, peak, bottom, thickness, step, and calculations</p> <p>Filter: Smooth, average, and differentiation</p> <p>Outputs: Scaling, various hold values, and zero reset</p> <p>I/O settings: Linear (focus/correction), judgments (hysteresis and timer), non-measurement, and bank (switching and clear) *2</p> <p>System: Save, initialization, measurement information display, communications settings, key lock, language, and data load</p> <p>Task: ZS-HLDC□1: Single task or multitask (up to 4) ZS-LDC□1: Single task</p>		
Status indicators		HIGH (orange), PASS (green), LOW (orange), LDON (green), ZERO (orange), and ENABLE (green)		
Segment display	Main digital	8-segment red LED, 6 digits		
	Sub-digital	8-segment green LEDs, 6 digits		
LCD		16 digits x 2 rows, Color of characters: green, Resolution per character: 5 x 8 pixel matrix		
Setting	Setting keys	Direction keys (UP, DOWN, LEFT, and RIGHT), SET key, ESC key, MENU key, and function keys (1 to 4)		
	Slide switch	Threshold switch (2 states: High/Low), mode switch (3 states: FUN, TEACH, and RUN)		
Power supply voltage		21.6 V to 26.4 VDC (including ripple)		
Current consumption		0.5 A max. (when Sensor Head is connected)		
Ambient temperature		Operating: 0 to 50°C, Storage: -15 to +60°C (with no icing or condensation)		
Ambient humidity		Operating and storage: 35% to 85% (with no condensation)		
Degree of protection		IP20 (IEC60529)		
Materials		Case: Polycarbonate (PC)		
Cable length		2 m		
Weight		Approx. 280 g (excluding packing materials and accessories)		
Accessories		Ferrite core (1), instruction sheet		

*1 Can be used with ZS-HLDC□1 when Multitask Mode selected.

*2 Terminal block output is a function of the ZS-HLDC□1.

ZS-HL-series Sensor Heads

Item	Model	ZS-HLDS2T	ZS-HLDS2VT	ZS-HLDS5T	ZS-HLDS10	ZS-HLDS60	ZS-HLDS150	
Applicable Controllers	ZS-HLDC series							
Optical system	Regular reflection	Diffuse reflection	Regular reflection	Diffuse reflection	Regular reflection	Diffuse reflection	Diffuse reflection	
Measuring center distance	20 mm	5.2 mm	25 mm	50 mm	44 mm	100 mm	94 mm	
Measuring range	±1 mm	±1 mm	±2 mm	±5 mm	±4 mm	±20 mm	±16 mm	
Light source	Visible semiconductor laser (wavelength: 650 nm, 1 mW max., JIS Class 2)							
Beam shape	Line beam							
Beam diameter *1	1.0mm × 20 μm	2.2mm × 45 μm	1.0mm × 30 μm	3.5mm × 60 μm	16 × 0.3 mm (at 500 mm)	40 × 1.5 mm (at 1,500 mm)		
Linearity *2	±0.05% F.S.	±0.2% F.S.	±0.1% F.S.			±0.07% F.S. (250 to 750 mm) ±0.1% F.S. (750 to 950 mm)	±0.2% F.S.	
Resolution *3	0.25 μm (No. of samples to average: 256)	0.6 μm (No. of samples to average: 128)	0.25 μm (No. of samples to average: 512)	1 μm (No. of samples to average: 64)		8 μm (No. of samples to average: 64 at 250 mm), 40 μm (No. of samples to average: 64 at 600 mm)	500 μm (No. of samples to average: 64)	
Temperature characteristic *4	0.01% F.S./°C	±0.1% F.S./°C	0.01% F.S./°C					
Sampling cycle	110 μs (High-speed Mode), 500 μs (Standard Mode), 2.2 μs (High-precision Mode), 4.4 μs (High-sensitivity Mode)							
LED Indicators	NEAR indicator	Lights near the measuring center distance, and closer than the measuring center distance inside the measuring range. Flashes when the measurement target is outside of the measuring range or when the received light amount is insufficient.						
	FAR indicator	Lights near the measuring center distance, and farther than the measuring center distance inside the measuring range. Flashes when the measurement target is outside of the measuring range or when the received light amount is insufficient.						
Operating ambient illumination	Illumination on received light surface: 3000 lx or less (incandescent light)				Illumination on received light surface: 1000 lx or less (incandescent light)		Illumination on received light surface: 500 lx or less (incandescent light)	
Ambient temperature	Operating: 0 to 50°C, Storage: -15 to 60°C (with no icing or condensation)							
Ambient humidity	Operating and storage: 35% to 85% (with no condensation)							
Degree of protection *5	IP64	IP67	Cable length 0.5 m: IP66, cable length 2 m: IP67			IP66 *6		
Materials	Case: Aluminum die-cast, Front cover: Glass							
Cable length	0.5 m, 2 m	2 m	0.5 m, 2 m					
Weight	Approx. 350 g		Approx. 600 g			Approx. 800 g		
Accessories	ZS-HLDS2V: Laser labels (1 each for JIS/EN), ferrite cores (2), insure locks (2), instruction sheet ZS-HLDS2/-HLDS5/-HLDS10/-HLDS60/-HLDS150: Laser labels (1 each for JIS/EN, 3 for FDA), ferrite cores (4), insure locks (2), instruction sheet							

*1 Defined as 1/e² (13.5%) of the center optical intensity at the actual measuring center distance (effective value).
The beam diameter is sometimes influenced by the ambient conditions of the workpiece, such as leaked light from the main beam.

*2 This is the error in the measured value with respect to an ideal straight line.
Linearity may change according to the workpiece.
The following options are available.

Model	Diffuse reflection	Mirror reflection
ZS-HLDS2T	SUS block	Glass
ZS-HLDS2VT	---	Glass
ZS-HLDS5T	White alumina ceramic	Glass
ZS-HLDS10	White alumina ceramic	
ZS-HLDS60/HLDS150	White alumina ceramic	---

*3 This is the peak-to-peak displacement conversion value in the displacement output at the measuring center distance in high-precision mode when the number of samples to average is set to within the graph. The maximum resolution at 250 mm is also shown for the ZS-HLDS60. The following options are available.

Model	Diffuse reflection	Mirror reflection
ZS-HLDS2T	SUS block	Glass
ZS-HLDS2VT	---	Glass
ZS-HLDS5T	White alumina ceramic	Glass
ZS-HLDS10	White alumina ceramic	
ZS-HLDS60/HLDS150	White alumina ceramic	---

*4 This is the value obtained at the measuring center distance when the Sensor and workpiece are fixed by an aluminum jig. (typical example)

*5 Protection structure of connector area is IP40.

*6 Ask your OMRON representative about Sensor Heads with IP67 protection.

ZS-L-series Sensor Heads

Item	Model	ZS-LD20T		ZS-LD20ST		ZS-LD40T		ZS-LD10GT	ZS-LD15GT
Applicable Controllers	ZS-HLDC/LDC Series								
Optical system	Regular reflection	Diffuse reflection	Regular reflection	Diffuse reflection	Regular reflection	Diffuse reflection	Regular reflection		
Measuring center distance	20 mm	6.3 mm	20 mm	6.3 mm	40 mm	30 mm	10 mm	15 mm	
Measuring range	±1 mm	±1 mm	±1 mm	±1 mm	±2.5 mm	±2 mm	±0.5 mm	±0.75 mm	
Light source	Visible semiconductor laser (wavelength: 650 nm, 1 mW max., JIS Class 2)								
Beam shape	Line beam		Spot beam		Line beam				
Beam diameter *1	900 × 25 μm		25 μm dia.		2,000 × 35 μm		Approx. 25 × 900 μm		
Linearity *2	±0.1% F.S.								
Resolution *3	0.25 μm		0.25 μm		0.4 μm		0.25 μm	0.25 μm	
Temperature characteristic *4	0.04% F.S./°C		0.04% F.S./°C		0.02% F.S./°C		0.04% F.S./°C		
Sampling cycle	110 μs (High-speed Mode), 500 μs (Standard Mode), 2.2 ms (High-precision Mode), 4.4 ms (High-sensitivity Mode)								
LED Indicators	NEAR indicator	Lights near the measuring center distance, and closer than the measuring center distance inside the measuring range. Flashes when the measurement target is outside of the measuring range or when the received light amount is insufficient.							
	FAR indicator	Lights near the measuring center distance, and farther than the measuring center distance inside the measuring range. Flashes when the measurement target is outside of the measuring range or when the received light amount is insufficient.							
Operating ambient illumination	Illumination on received light surface: 3000 lx or less (incandescent light)								
Ambient temperature	Operating: 0 to 50°C, Storage: -15 to 60°C (with no icing or condensation)								
Ambient humidity	Operating and storage: 35% to 85% (with no condensation)								
Degree of protection *5	Cable length 0.5 m: IP66, cable length 2 m: IP67						IP40		
Materials	Case: Aluminum die-cast, Front cover: Glass								
Cable length	0.5 m, 2 m								
Weight	Approx. 350 g						Approx. 400 g		
Accessories	Laser labels (1 each for JIS/EN, 3 for FDA), ferrite cores (2), insure locks (2), instruction sheet						Laser safety labels (1 each for JIS/EN), ferrite cores (2), insure locks (2)		

- *1 Defined as 1/e² (13.5%) of the center optical intensity at the actual measuring center distance (effective value). The beam diameter is sometimes influenced by the ambient conditions of the workpiece, such as leaked light from the main beam.
- *2 This is the error in the measured value with respect to an ideal straight line. The standard workpiece is white aluminum ceramics and glass in the regular reflection mode. Linearity may change according to the workpiece.
- *3 This is the peak-to-peak displacement conversion value in the displacement output at the measuring center distance in high-precision mode when the number of samples to average is set to 128 and the measuring mode is set to the high-resolution mode. The standard workpiece is white aluminum ceramics and glass in the regular reflection mode.
- *4 This is the value obtained at the measuring center distance when the Sensor and workpiece are fixed by an aluminum jig. (typical example)
- *5 Protection structure of connector area is IP40.

ZS-L-series Sensor Heads

Item	Model	ZS-LD50	ZS-LD50S	ZS-LD80	ZS-LD130	ZS-LD200	ZS-LD350S
Applicable Controllers	ZS-HLDC/LDC Series						
Optical system	Diffuse reflection	Regular reflection	Diffuse reflection	Regular reflection	Diffuse reflection	Regular reflection	Diffuse reflection
Measuring center distance	50 mm	47 mm	50 mm	47 mm	80 mm	78 mm	130 mm
Measuring range	±5 mm	±4 mm	±5 mm	±4 mm	±15 mm	±14 mm	±15 mm
Light source	Visible semiconductor laser (wavelength: 650 nm, 1 mW max., JIS Class 2)						
Beam shape	Line beam	Spot beam	Line beam	Line beam	Line beam	Line beam	Spot beam
Beam diameter *1	900 × 60 μm	50 μm dia.	900 × 60 μm	600 × 70 μm	900 × 100 μm	240 μm dia.	
Linearity *2	±0.1% F.S.					±0.25% F.S.	±0.1% F.S.
Resolution *3	0.8 μm	0.8 μm	2 μm	3 μm	5 μm	20 μm	
Temperature characteristic *4	0.02% F.S./°C	0.02% F.S./°C	0.01% F.S./°C	0.02% F.S./°C	0.02% F.S./°C	0.04% F.S./°C	
Sampling cycle	110 μs (High-speed Mode), 500 μs (Standard Mode), 2.2 ms (High-precision Mode), 4.4 ms (High-sensitivity Mode)						
LED Indicators	NEAR indicator	Lights near the measuring center distance, and closer than the measuring center distance inside the measuring range. Flashes when the measurement target is outside of the measuring range or when the received light amount is insufficient.					
	FAR indicator	Lights near the measuring center distance, and farther than the measuring center distance inside the measuring range. Flashes when the measurement target is outside of the measuring range or when the received light amount is insufficient.					
Operating ambient illumination	Illumination on received light surface: 3000 lx or less (incandescent light)				Illumination on received light surface: 2000 lx or less (incandescent light)		Illumination on received light surface: 3000 lx or less (incandescent light)
Ambient temperature	Operating: 0 to 50°C, Storage: -15 to 60°C (with no icing or condensation)						
Ambient humidity	Operating and storage: 35% to 85% (with no condensation)						
Degree of protection *5	Cable length 0.5 m: IP66, cable length 2 m: IP67						
Materials	Case: Aluminum die-cast, Front cover: Glass						
Cable length	0.5 m, 2 m						
Weight	Approx. 350g						
Accessories	Laser labels (1 each for JIS/EN, 3 for FDA), ferrite cores (2), insure locks (2), instruction sheet						

- *1 Defined as $1/e^2$ (13.5%) of the center optical intensity at the actual measuring center distance (effective value). The beam diameter is sometimes influenced by the ambient conditions of the workpiece, such as leaked light from the main beam.
- *2 This is the error in the measured value with respect to an ideal straight line. The standard workpiece is white aluminum ceramics and glass in the ZS-LD50/LD50S regular reflection mode. Linearity may change according to the workpiece.
- *3 This is the peak-to-peak displacement conversion value in the displacement output at the measuring center distance in high-precision mode when the number of samples to average is set to 128 and the measuring mode is set to the high-resolution mode. The standard workpiece is white aluminum ceramics and glass in the ZS-LD50/LD50S regular reflection mode.
- *4 This is the value obtained at the measuring center distance when the Sensor and workpiece are fixed by an aluminum jig.
- *5 Protection structure of connector area is IP40.

ZS-MDC□1 Multi-Controllers

Basic specifications are the same as those for the ZS-LDC□1 Sensor Controllers.

The following points, however, are different.

1. Sensor Heads cannot be connected.
2. Control Link Units are required to connect up to 9 Controllers. Control Link Units are required to connect Controllers.
3. Processing functions between Controllers: Arithmetic functions

Controller Link Units

Connection Using the ZS-XCN

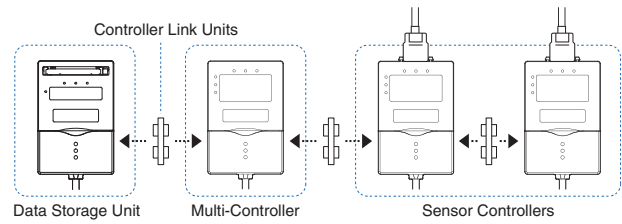

ZS-DSU□1 Data Storage Unit

Item	Model	ZS-DSU11	ZS-DSU41
Number of mounted Sensor Heads		Cannot be connected	
Number of connectable Controllers		10 max. (ZS-MDC: 1, ZS-HLDC/LDC: 9 max.) *	
Connectable Controllers		ZS-HLDC□□, ZS-LDC□□, ZS-MDC□□	
External interface	Connection method		Serial I/O: connector, Other: pre-wired (standard cable length: 2 m)
	Serial I/O	USB 2.0	1 port, Full Speed (12 Mbps max.), MINI-B
		RS-232C	1 port, 115,200 bps max.
	Output	3 outputs: HIGH, PASS, and LOW; NPN open-collector, 30 VDC, 50 mA max., residual voltage: 1.2 V max.	
Inputs	ON: Short-circuited with 0 V terminal or 1.5 V or less; OFF: Open (leakage current: 0.1 mA max.)		
Data resolution		32 bits	
Functions	Logging trigger functions		Start and stop triggers can be set separately; external triggers, data triggers (self-triggers), and time triggers
	Other functions		External banks, alarm outputs, saved data format customization, and clock
Status indicators		OUT (orange), PWR (green), ACCESS (orange), and ERR (red)	
Segment display		8-segment green LEDs, 6 digits	
LCD		16 digits x 2 rows, Color of characters: green, Resolution per character: 5 × 8 pixel matrix	
Setting inputs	Setting keys		Direction keys (UP, DOWN, LEFT, and RIGHT), SET key, ESC key, MENU key, and function keys (1 to 4)
	Slide switch		Threshold switch (2 states: High/Low), mode switch (3 states: FUN, TEACH, and RUN)
Power supply voltage		21.6 V to 26.4 VDC (including ripple)	
Current consumption		0.5 A max.	
Ambient temperature		Operating: 0 to 50°C, Storage: 0 to 60°C (with no icing or condensation)	
Ambient humidity		Operating and storage: 35% to 85% (with no condensation)	
Degree of protection		IP20 (IEC60529)	
Materials		Case: Polycarbonate (PC)	
Weight		Approx. 280 g (excluding packing materials and accessories)	
Accessories		Ferrite core (1), instruction sheet for Data Storage Unit: CSV File Converter for Data Storage Unit/Smart Analyzer Macro Edition	

* Control Link Units are required to connect Controllers.

Engineering Data (Reference Value)

Linearity Characteristic by Materials

ZS-HLDS2T (mode: High-Resolution)

Regular reflection

Inclination angle 0°

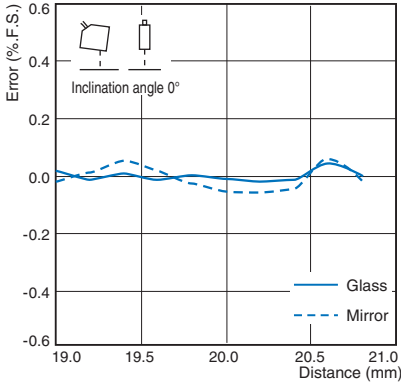

Inclination angle Vertical +0.5°

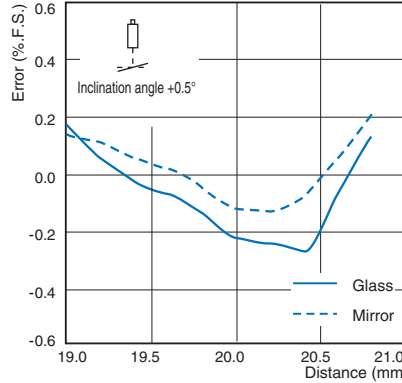

Inclination angle Horizontal +0.5°

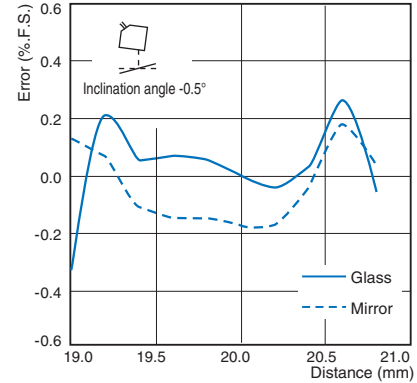

Inclination angle Vertical -0.5°

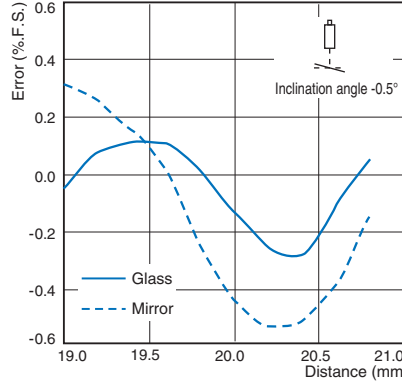

Inclination angle Horizontal -0.5°

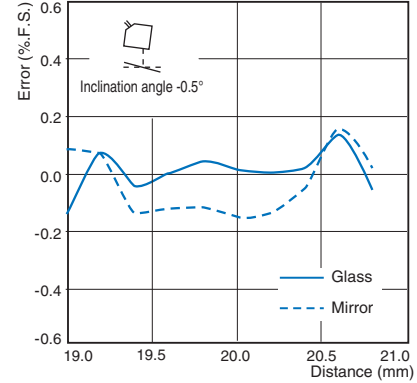

Diffuse reflection

Inclination angle 0°

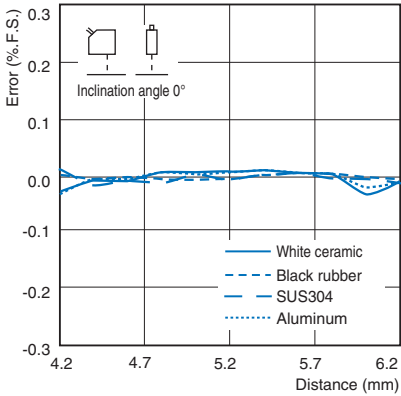

Inclination angle Vertical +30°

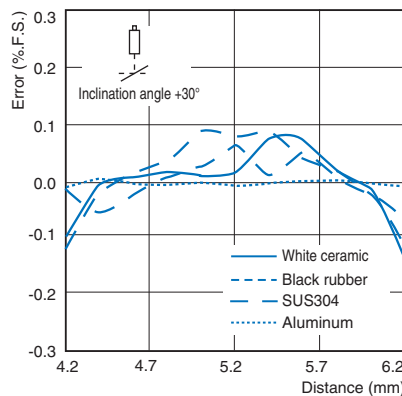

Inclination angle Horizontal +30°

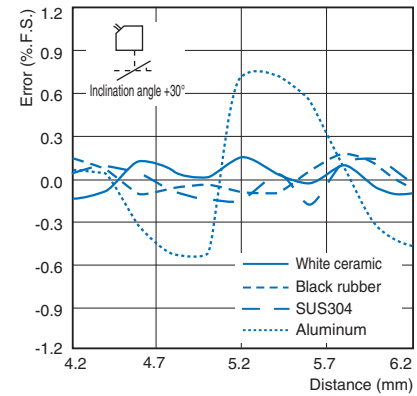

Inclination angle Vertical -30°

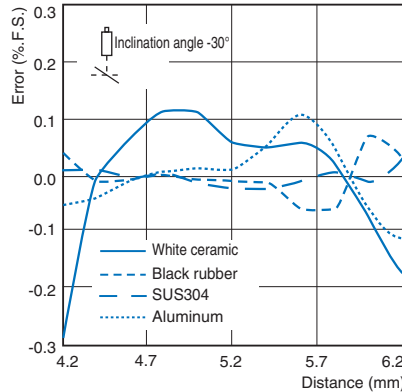

Inclination angle Horizontal -30°

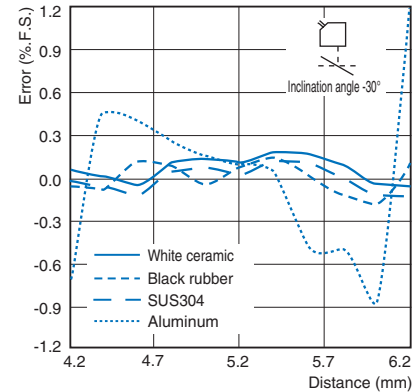

ZS-HLDS2VT (mode: High-Resolution)

Regular reflection

Inclination angle 0°

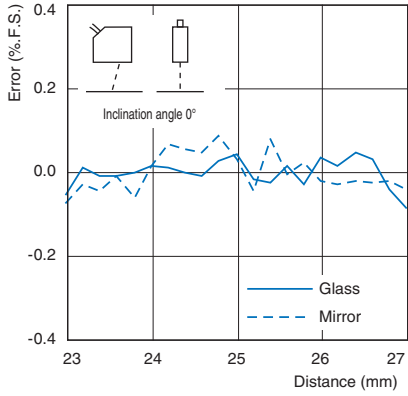

Inclination angle Vertical +0.5°

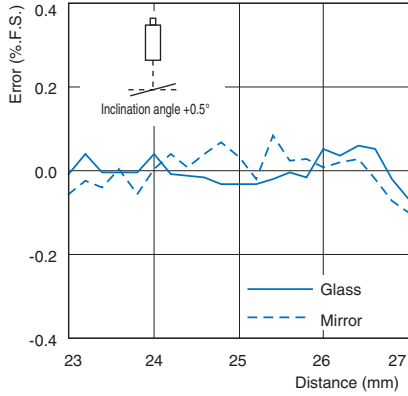

Inclination angle Vertical +1°

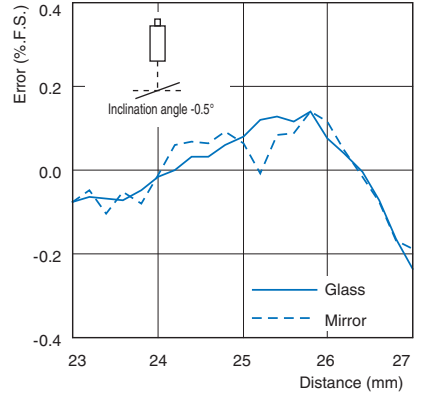

Inclination angle Vertical -0.5°

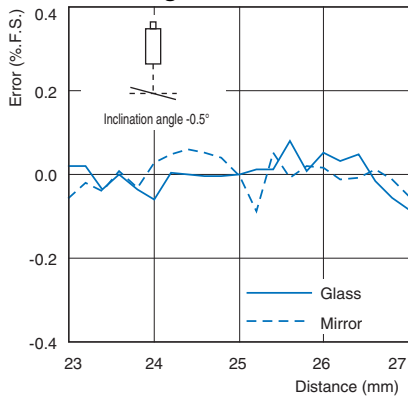

Inclination angle Vertical -1°

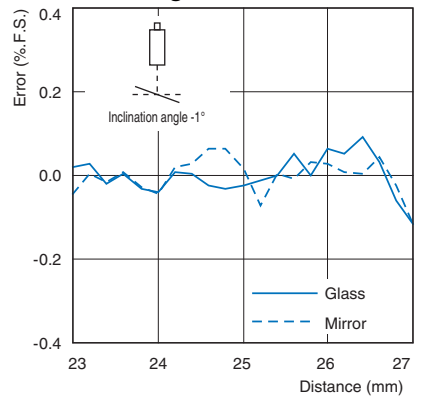

Inclination angle Horizontal +0.5°

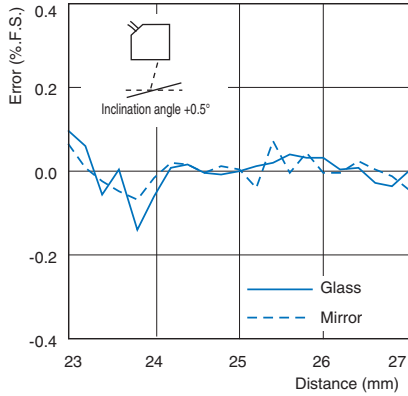

Inclination angle Horizontal +1°

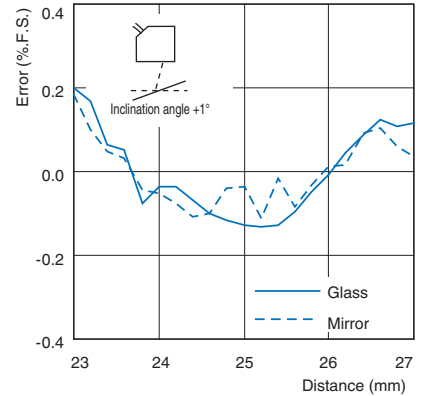

Inclination angle Horizontal -0.5°

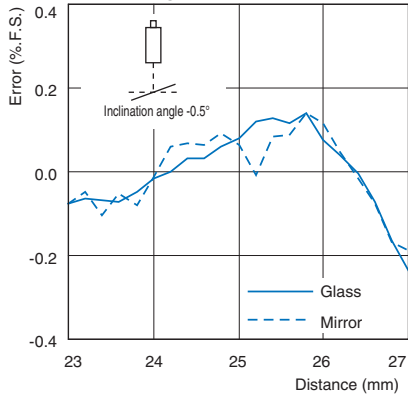

Inclination angle Horizontal -1°

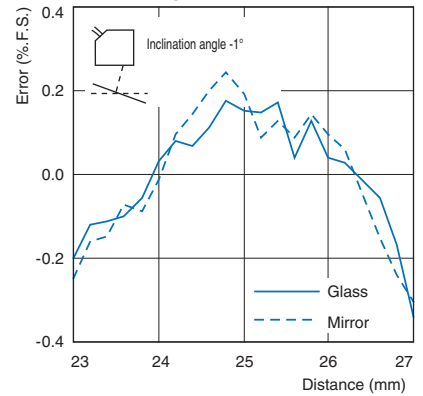

ZS-HLDS5T (mode: High-Resolution)

Diffuse reflection

Inclination angle 0°

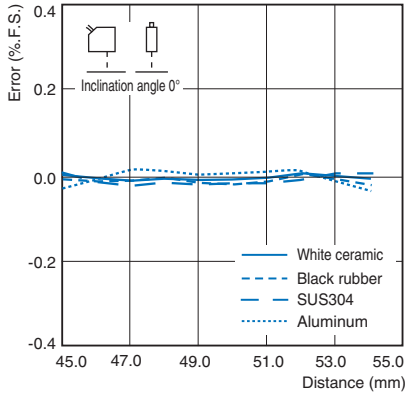

Inclination angle Vertical +45°

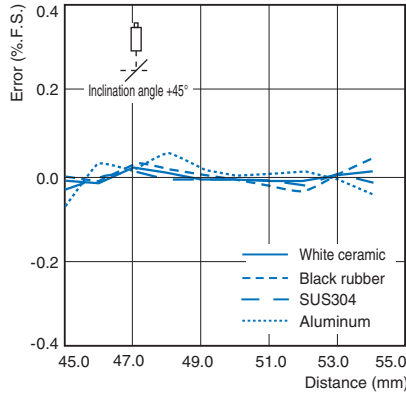

Inclination angle Horizontal +45°

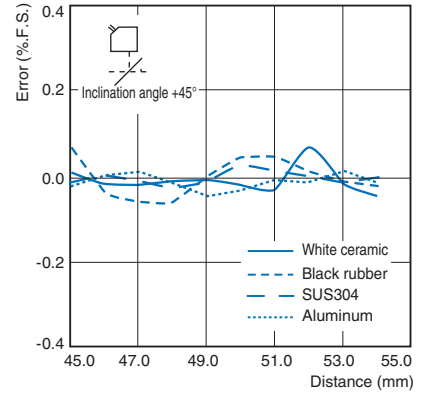

Inclination angle Vertical -45°

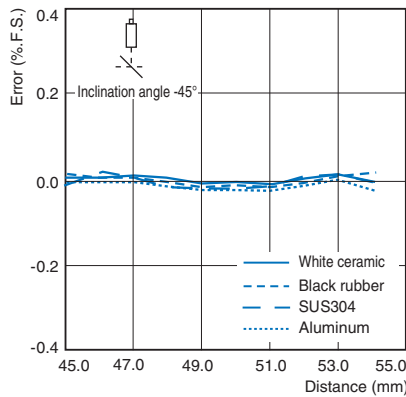

Inclination angle Horizontal -45°

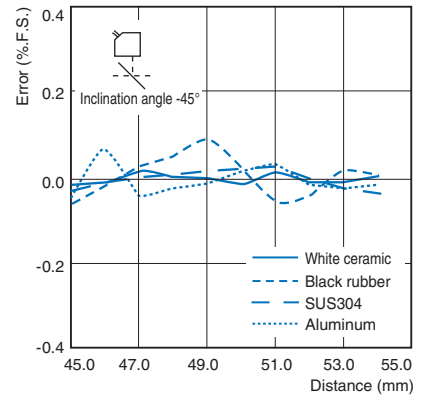

Regular reflection

Inclination angle 0°

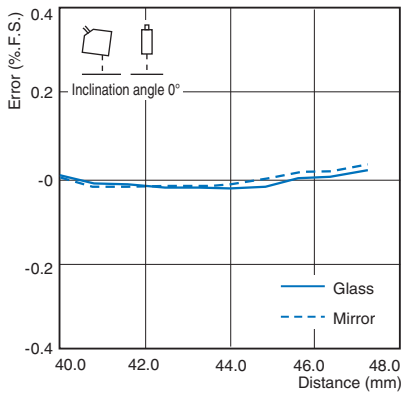

Inclination angle Vertical +0.5°

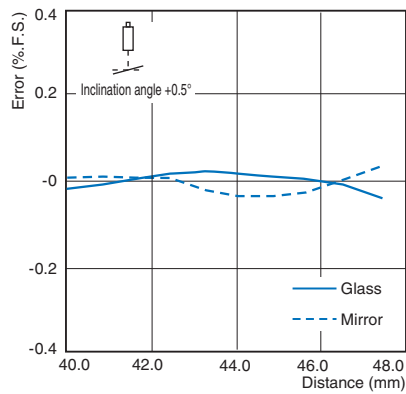

Inclination angle Horizontal +0.5°

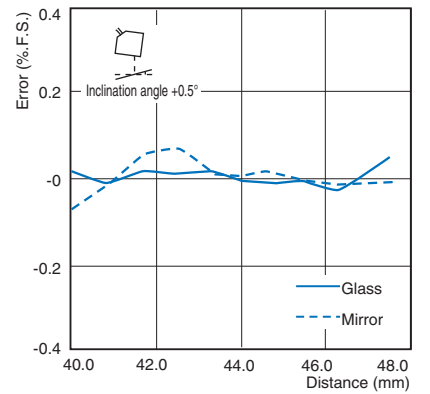

Inclination angle Vertical -0.5°

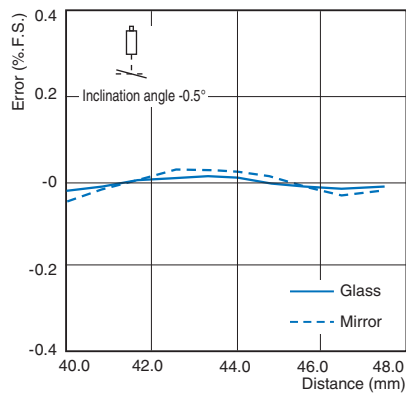

Inclination angle Horizontal -0.5°

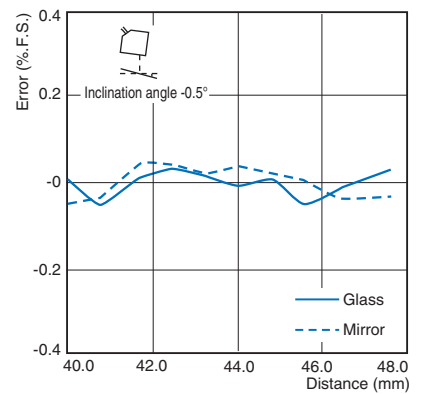

ZS-HLDS10 (mode: High-Resolution)

Diffuse reflection

Inclination angle 0°

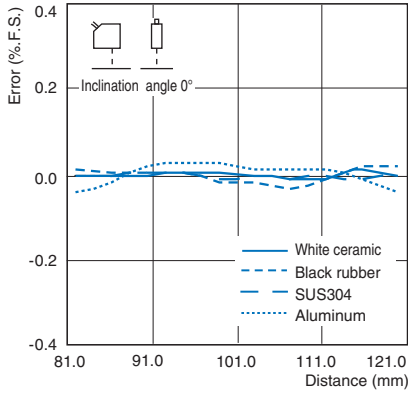

Inclination angle Vertical +45°

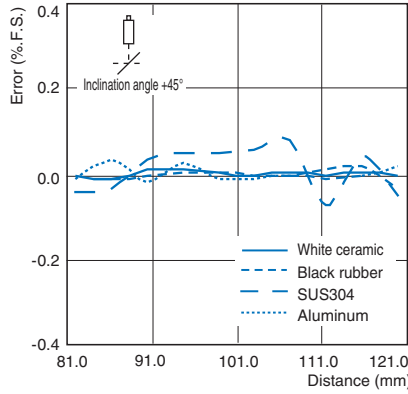

Inclination angle Horizontal +45°

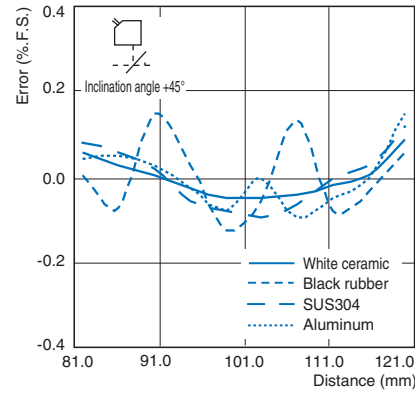

Inclination angle Vertical -45°

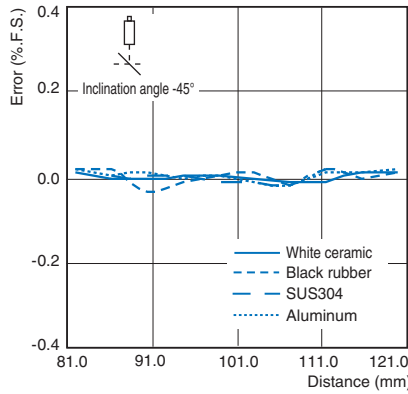

Inclination angle Horizontal -45°

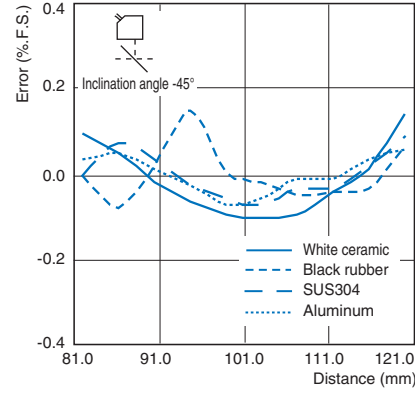

Regular reflection

Inclination angle 0°

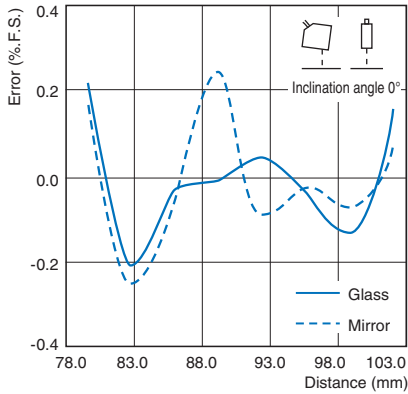

Inclination angle Vertical +0.5°

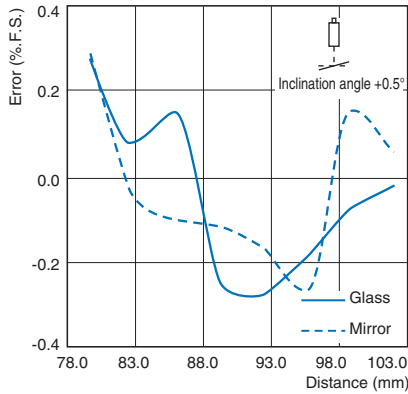

Inclination angle Horizontal +0.5°

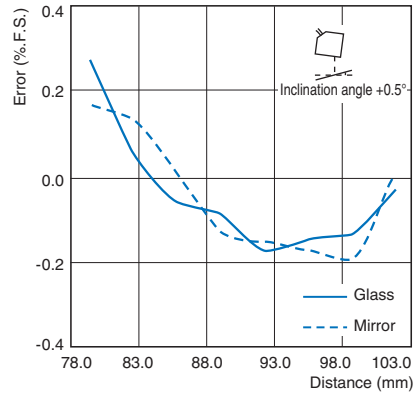

Inclination angle Vertical -0.5°

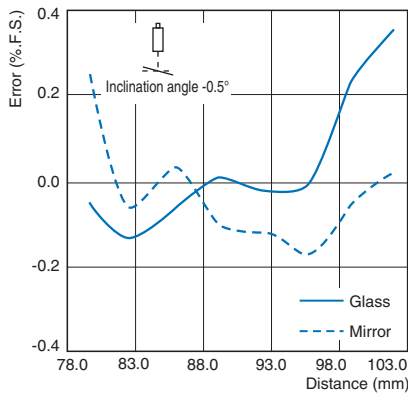

Inclination angle Horizontal -0.5°

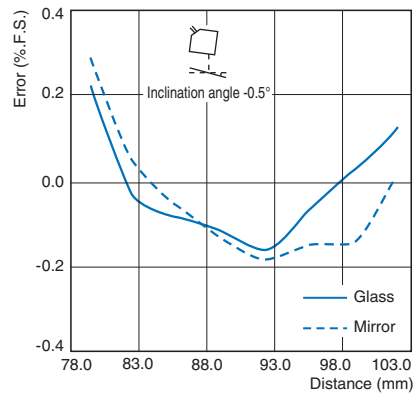

ZS-HLDS60 (mode: High-Resolution)

Diffuse reflection

Inclination angle 0°

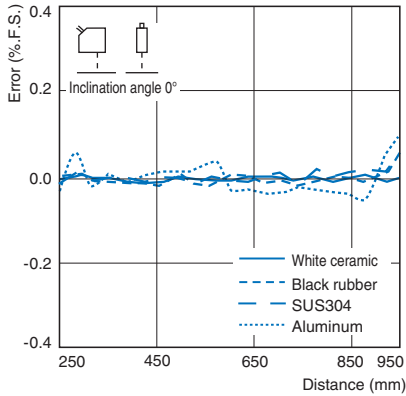

Inclination angle Vertical +45°

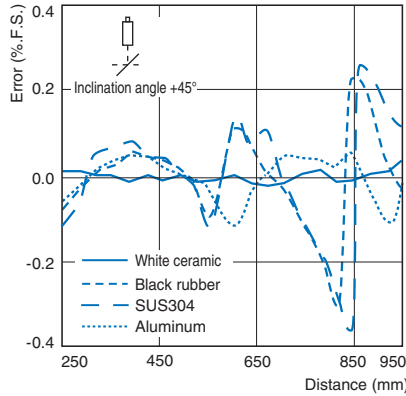

Inclination angle Horizontal +45°

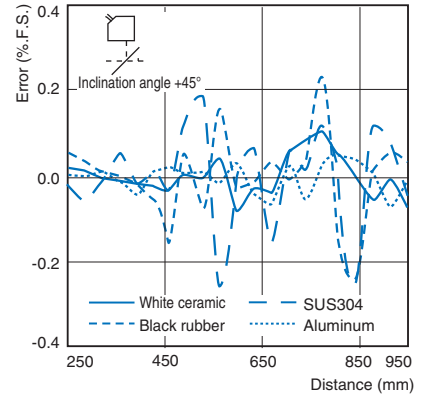

Inclination angle Vertical -45°

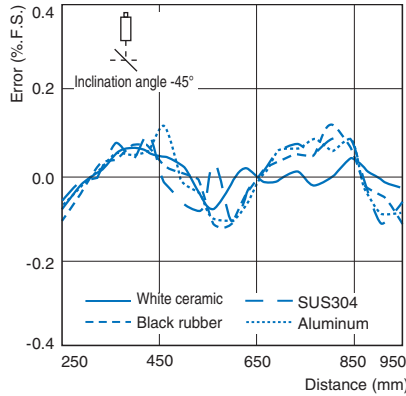

Inclination angle Horizontal -45°

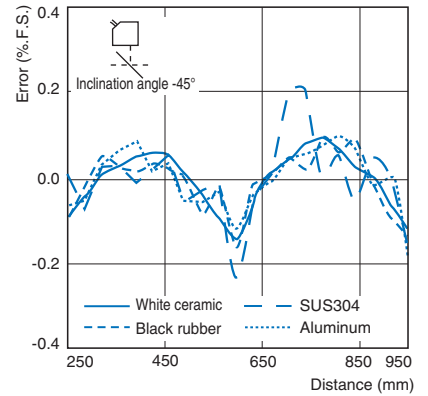

ZS-HLDS150 (mode: High-Resolution)

Diffuse reflection

Inclination angle 0°

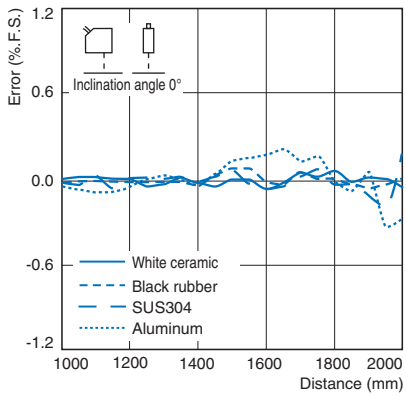

Inclination angle Vertical +45°

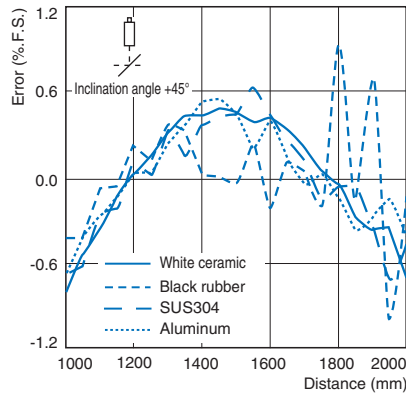

Inclination angle Horizontal +45°

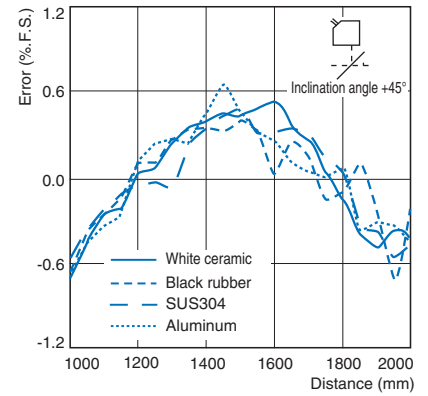

Inclination angle Vertical -45°

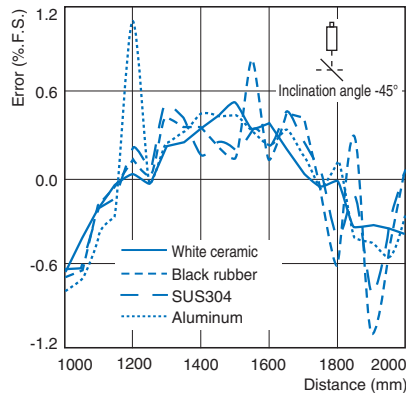

Inclination angle Horizontal -45°

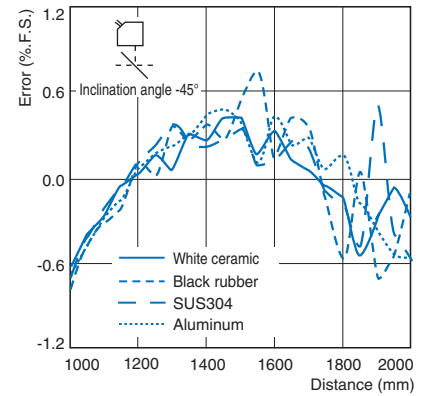

ZS-LD20T (mode: Standard)

Regular reflection

Inclination angle 0°

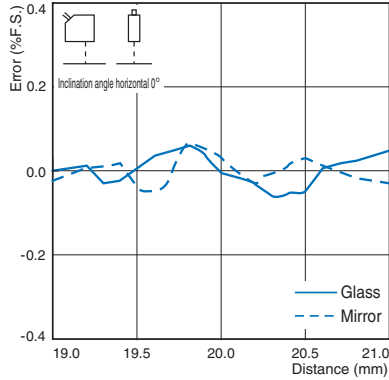

Inclination angle Horizontal +0.5°

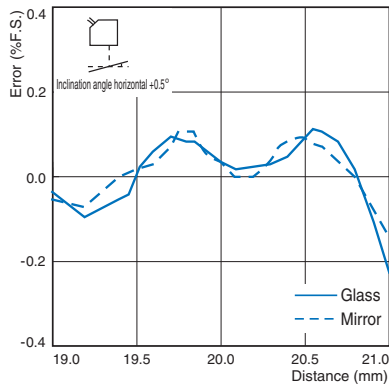

Inclination angle Horizontal -0.5°

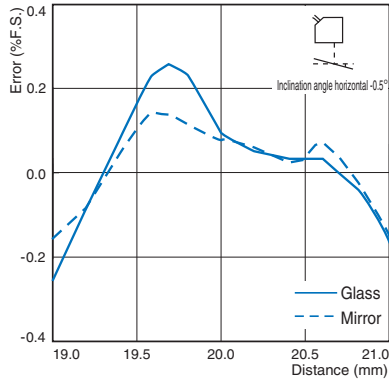

Inclination angle Vertical ±0.5°

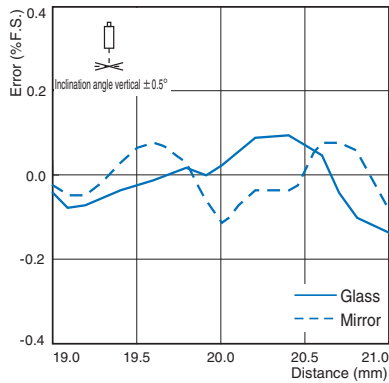

Diffuse reflection

Inclination angle 0°

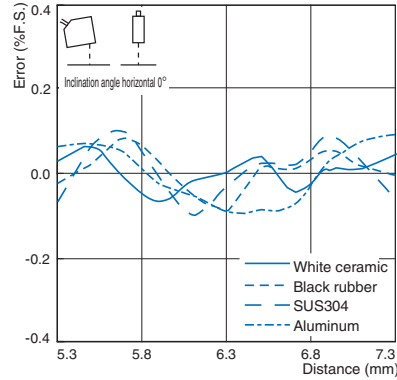

Inclination angle Horizontal +15°

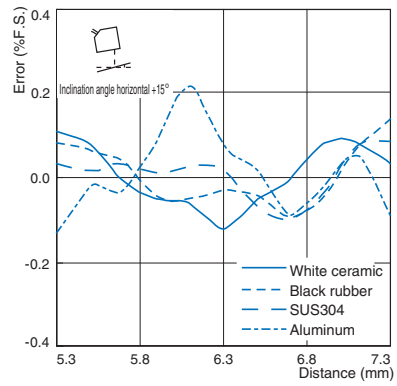

Inclination angle Horizontal -15°

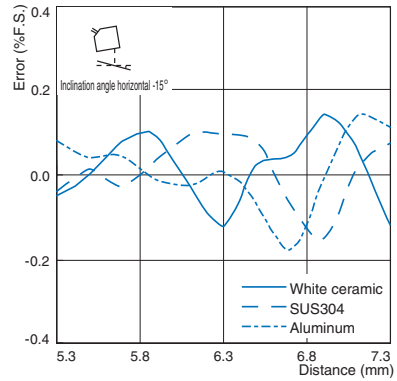

Inclination angle Vertical ±15°

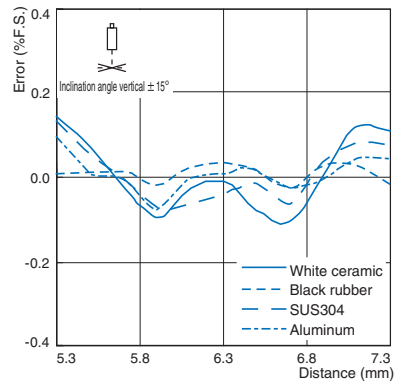

ZS-LD20ST (mode: Standard)

Regular reflection

Inclination angle 0°

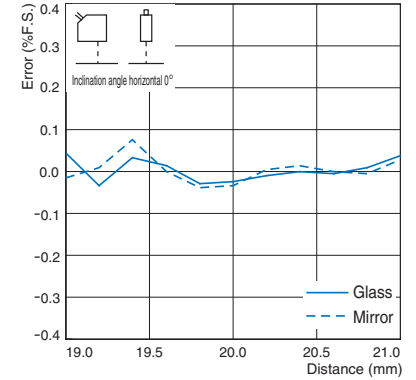

Inclination angle Horizontal +0.5°

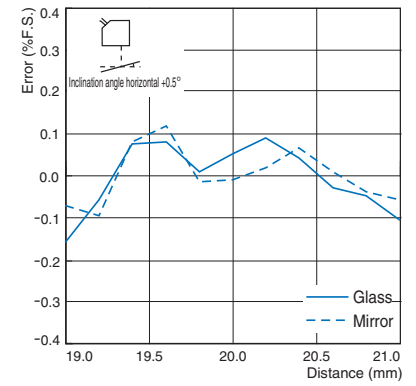

Inclination angle Horizontal -0.5°

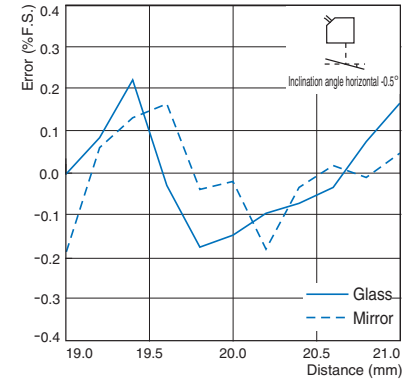

Inclination angle Vertical ±0.5°

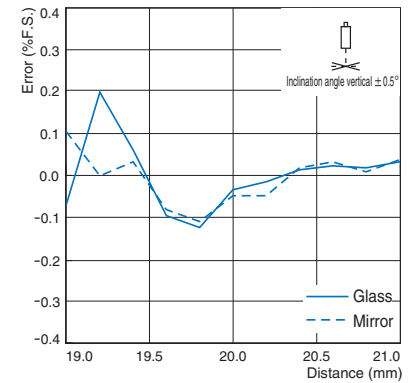

ZS-LD20ST (mode: Standard)

Diffuse reflection

Inclination angle 0°

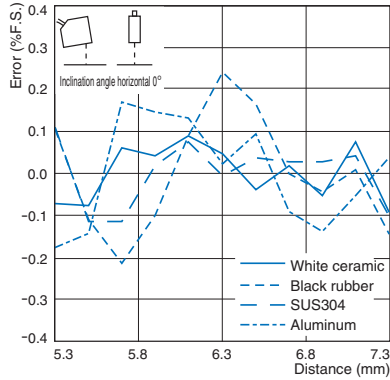

Inclination angle Horizontal +15°

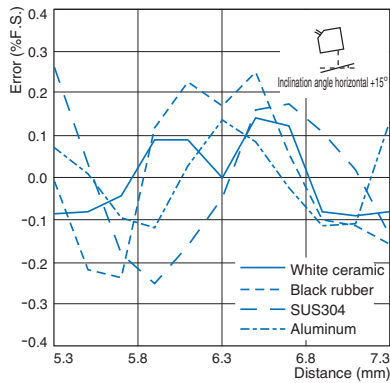

Inclination angle Horizontal -15°

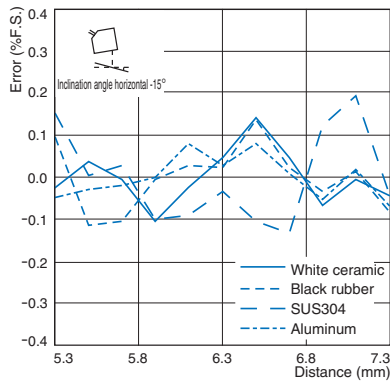

Inclination angle Vertical ±15°

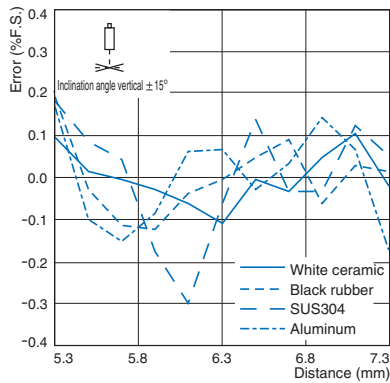

ZS-LD40T (mode: Standard)

Regular reflection

Inclination angle 0°

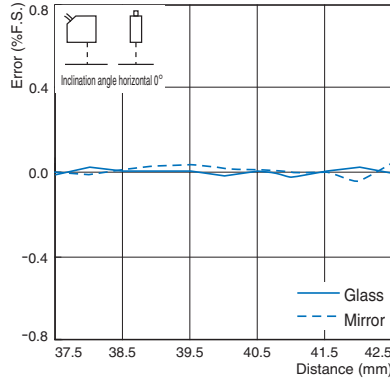

Inclination angle Horizontal +0.5°

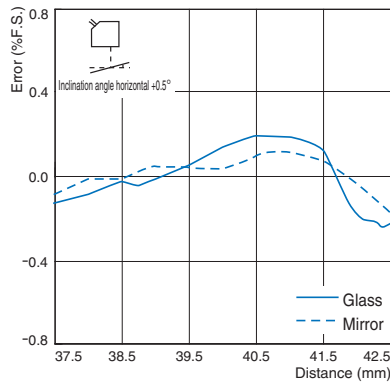

Inclination angle Horizontal -0.5°

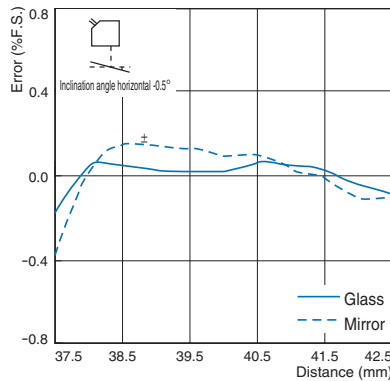

Inclination angle Vertical ±0.5°

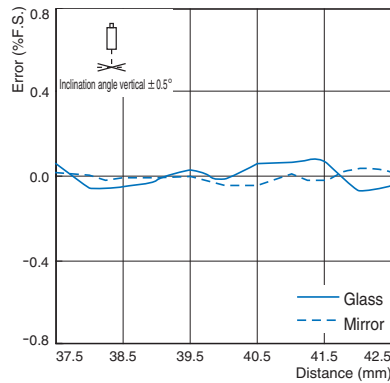

Diffuse reflection

Inclination angle 0°

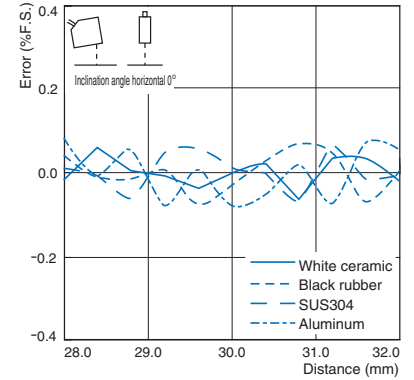

Inclination angle Horizontal +15°

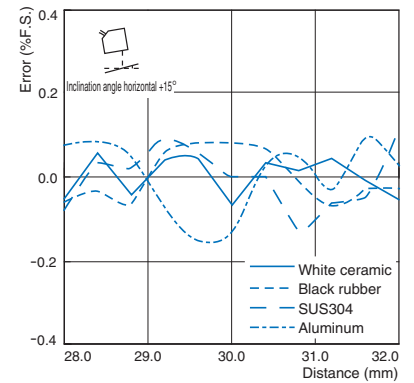

Inclination angle Horizontal -15°

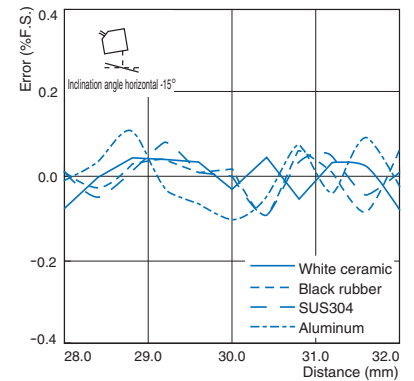

Inclination angle Vertical ±15°

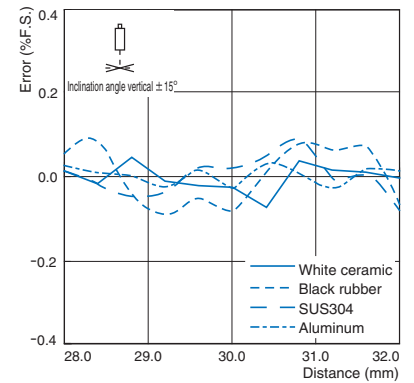

ZS-LD50 (mode: Standard)

Diffuse reflection

Inclination angle 0°

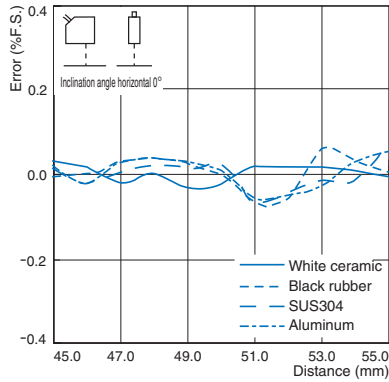

Inclination angle Horizontal +15°

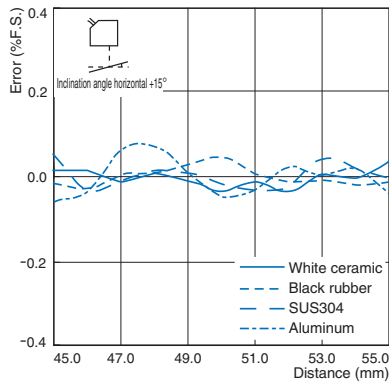

Inclination angle Horizontal -15°

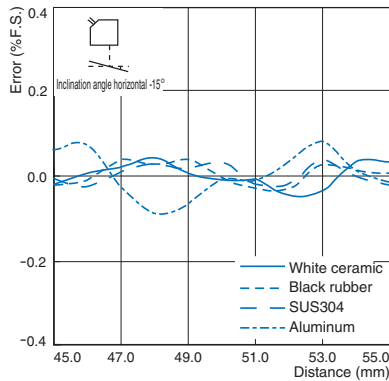

Inclination angle Vertical ±15°

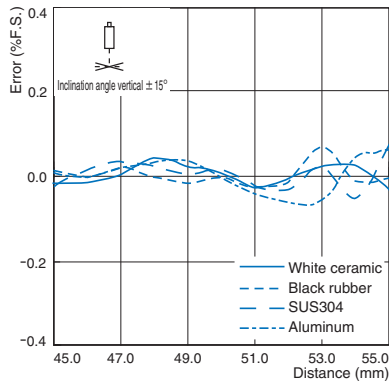

Regular reflection

Inclination angle 0°

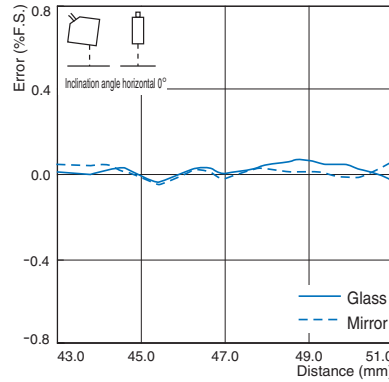

Inclination angle Horizontal +0.5°

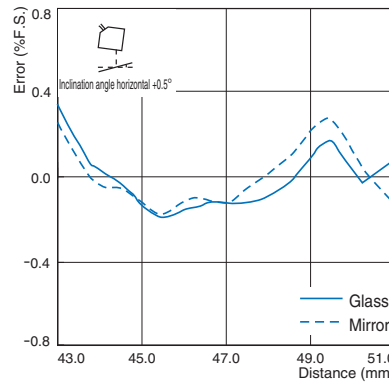

Inclination angle Horizontal -0.5°

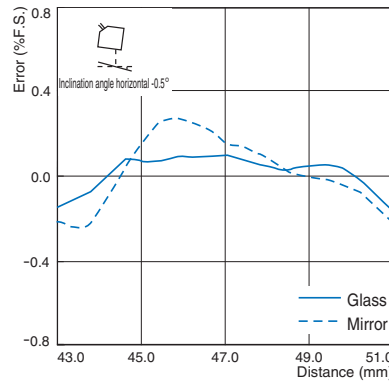

Inclination angle Vertical ±0.5°

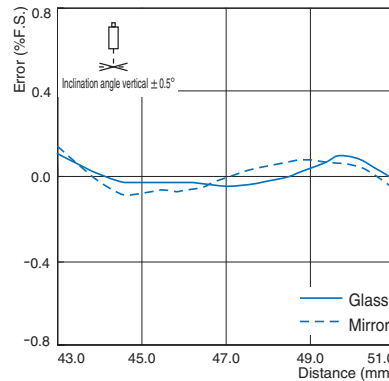

ZS-LD50S (mode: Standard)

Diffuse reflection

Inclination angle 0°

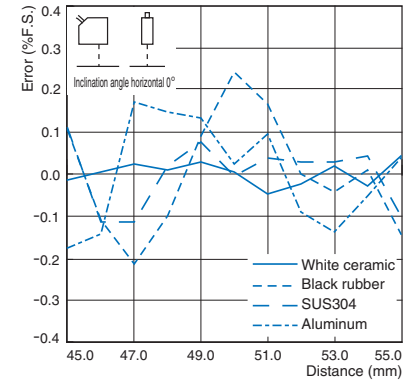

Inclination angle Horizontal +15°

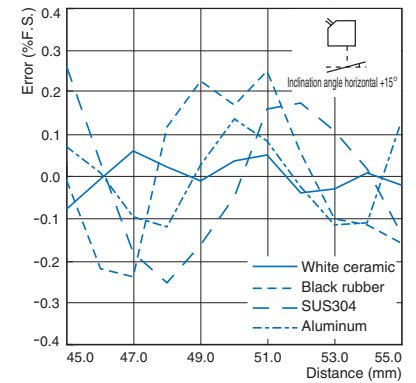

Inclination angle Horizontal -15°

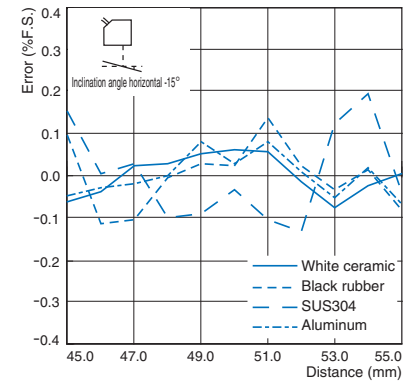

Inclination angle Vertical ±15°

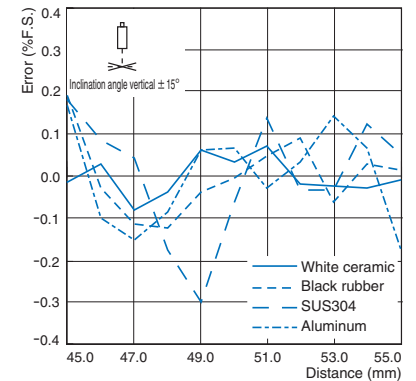

ZS-LD50S (mode: Standard)

Regular reflection

Inclination angle 0°

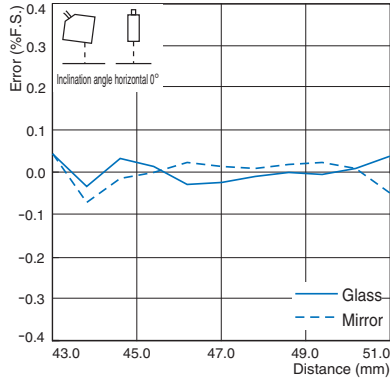

Inclination angle Horizontal +0.5°

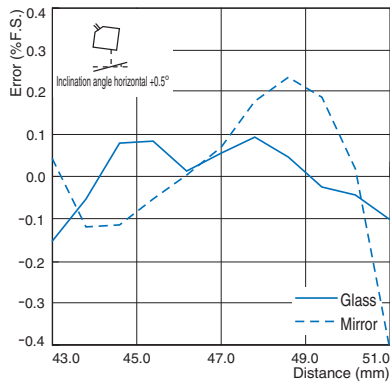

Inclination angle Horizontal -0.5°

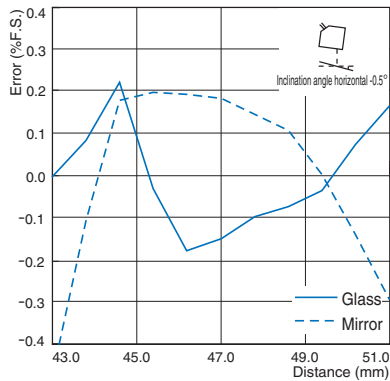

Inclination angle Vertical ±0.5°

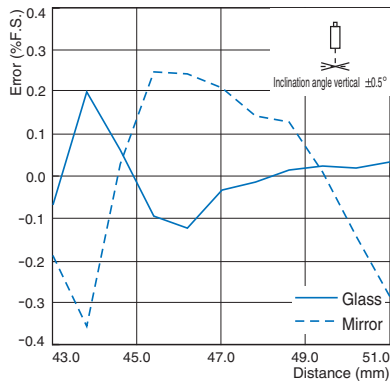

ZS-LD80 (mode: Standard)

Diffuse reflection

Inclination angle 0°

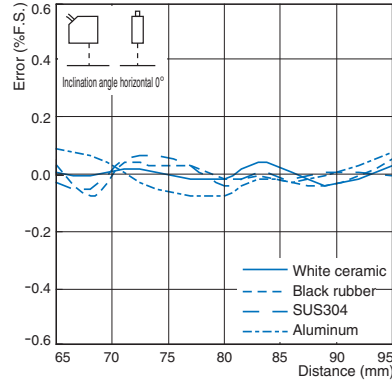

Inclination angle Horizontal +15°

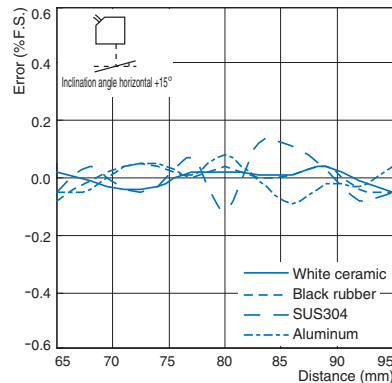

Inclination angle Horizontal -15°

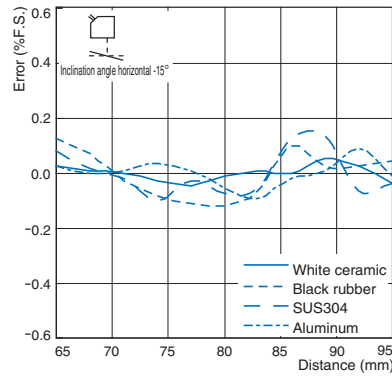

Inclination angle Vertical ±15°

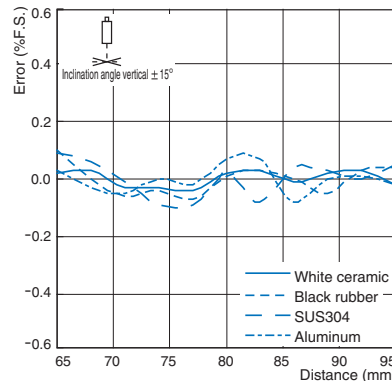

Regular reflection

Inclination angle 0°

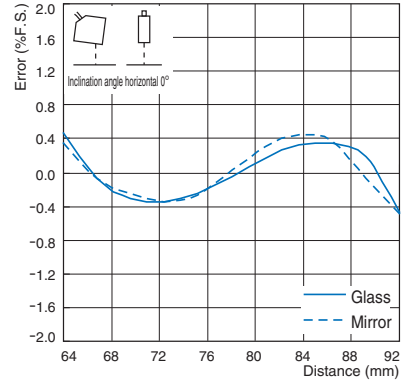

Inclination angle Horizontal +0.5°

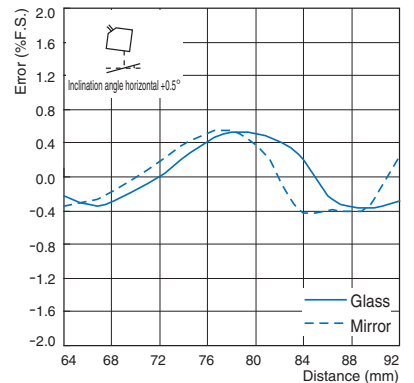

Inclination angle Horizontal -0.5°

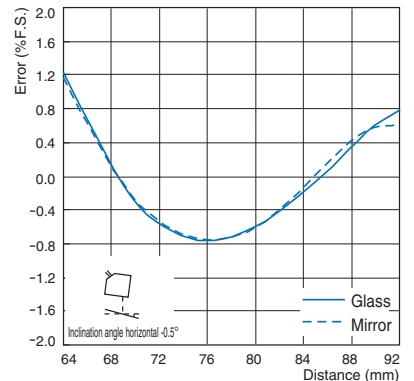

Inclination angle Vertical ±0.5°

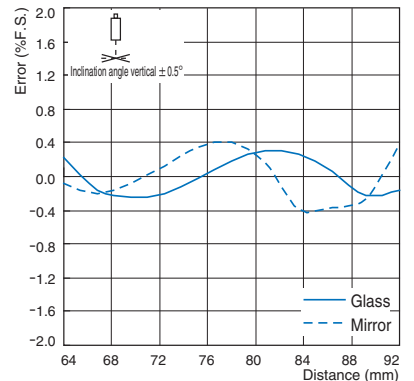

ZS-LD130 (mode: Standard)

Diffuse reflection

Inclination angle 0°

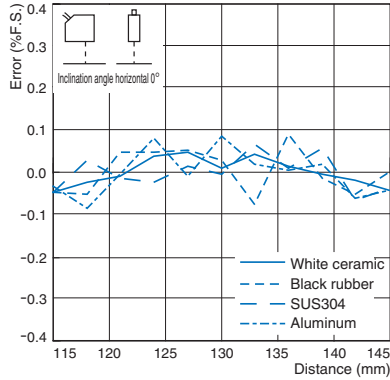

Inclination angle Horizontal +15°

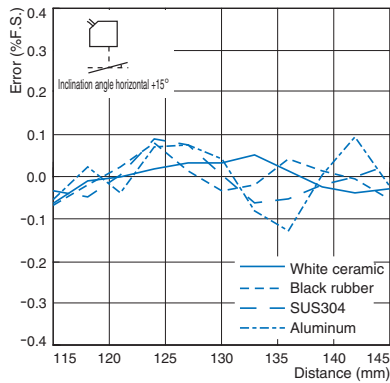

Inclination angle Horizontal -15°

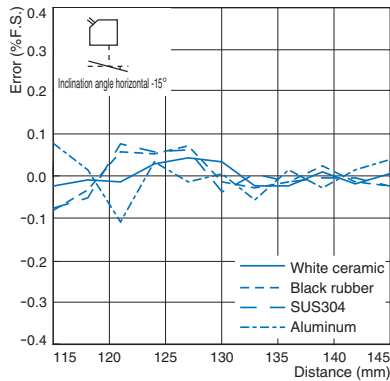

Inclination angle Vertical ±15°

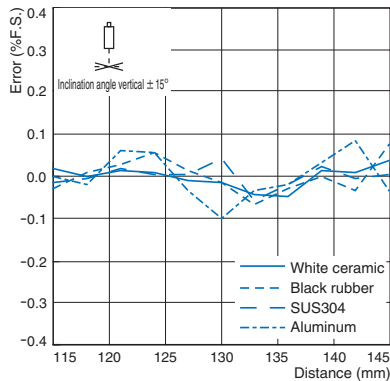

Regular reflection

Inclination angle 0°

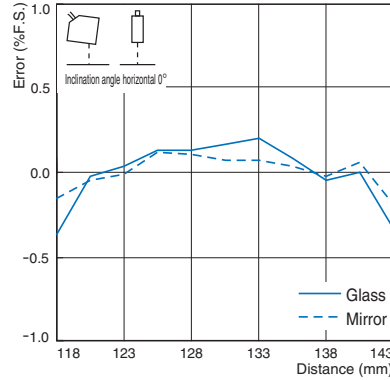

Inclination angle Horizontal +0.5°

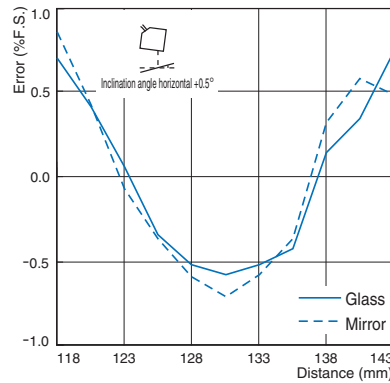

Inclination angle Horizontal -0.5°

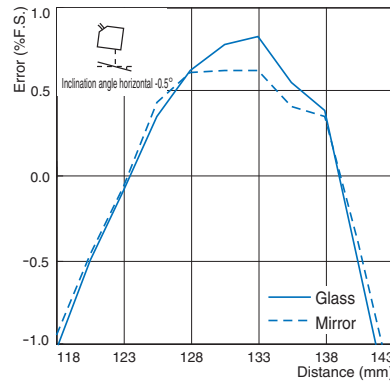

Inclination angle Vertical ±0.5°

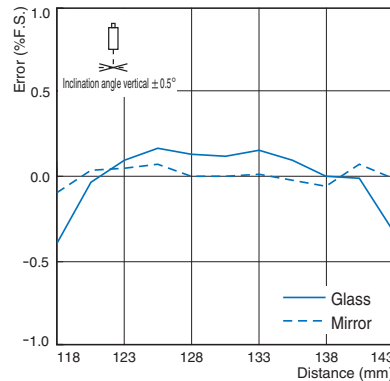

ZS-LD200 (mode: Standard)

Diffuse reflection

Inclination angle 0°

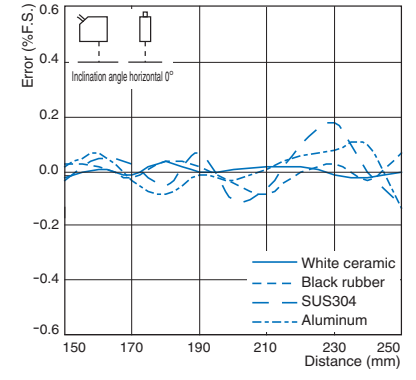

Inclination angle Horizontal +15°

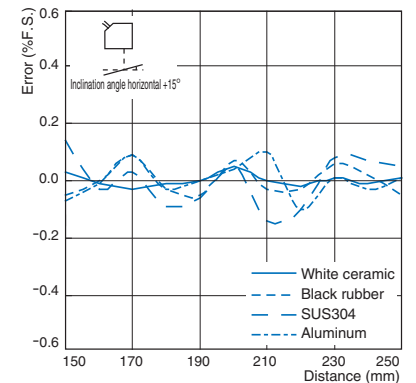

Inclination angle Horizontal -15°

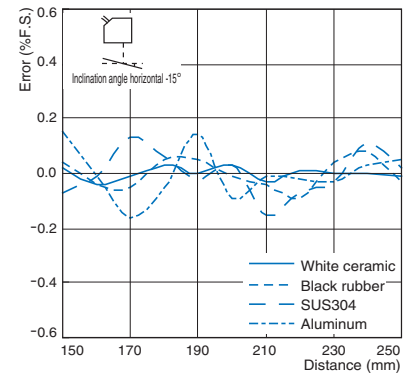

Inclination angle Vertical ±15°

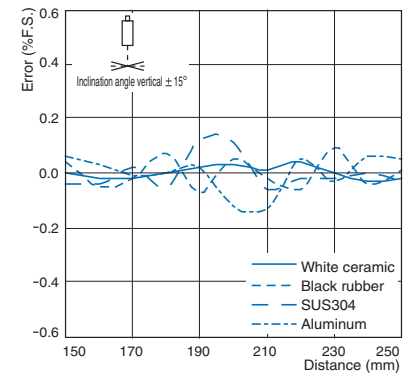

ZS-LD200 (mode: Standard)

Regular reflection

Inclination angle 0°

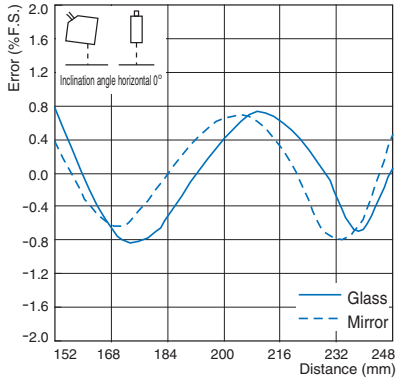

Inclination angle Horizontal +0.5°

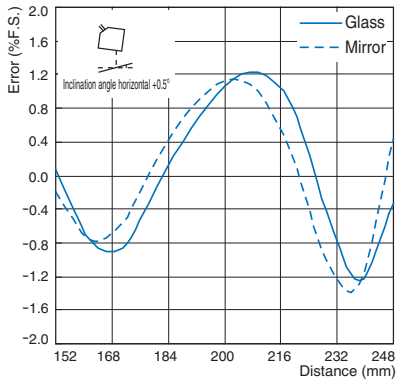

Inclination angle Horizontal -0.5°

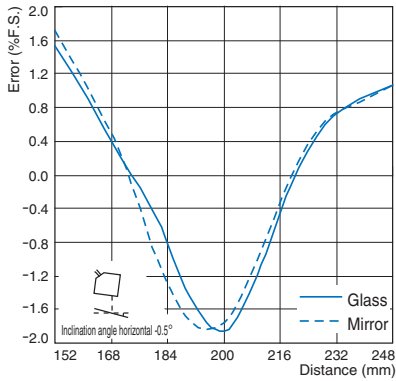

Inclination angle Vertical ±0.5°

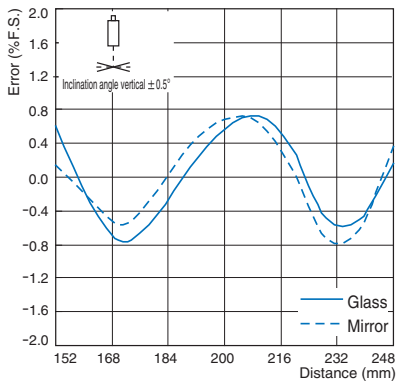

ZS-LD350S (mode: Standard)

Diffuse reflection

Inclination angle 0°

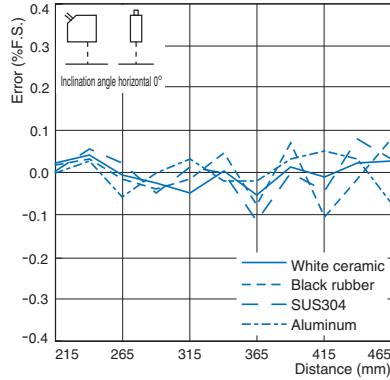

Inclination angle Horizontal +15°

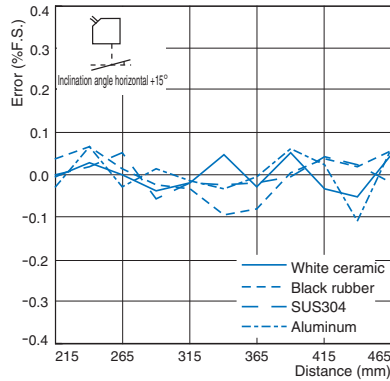

Inclination angle Horizontal -15°



Inclination angle Vertical ±15°

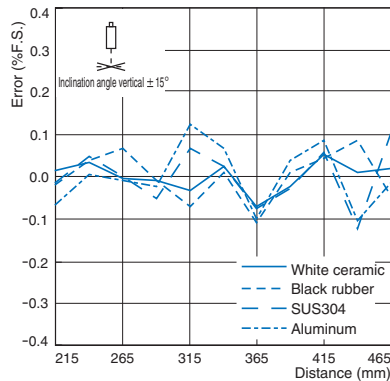

I/O Circuit Diagrams

NPN type (ZS-HLDC11)

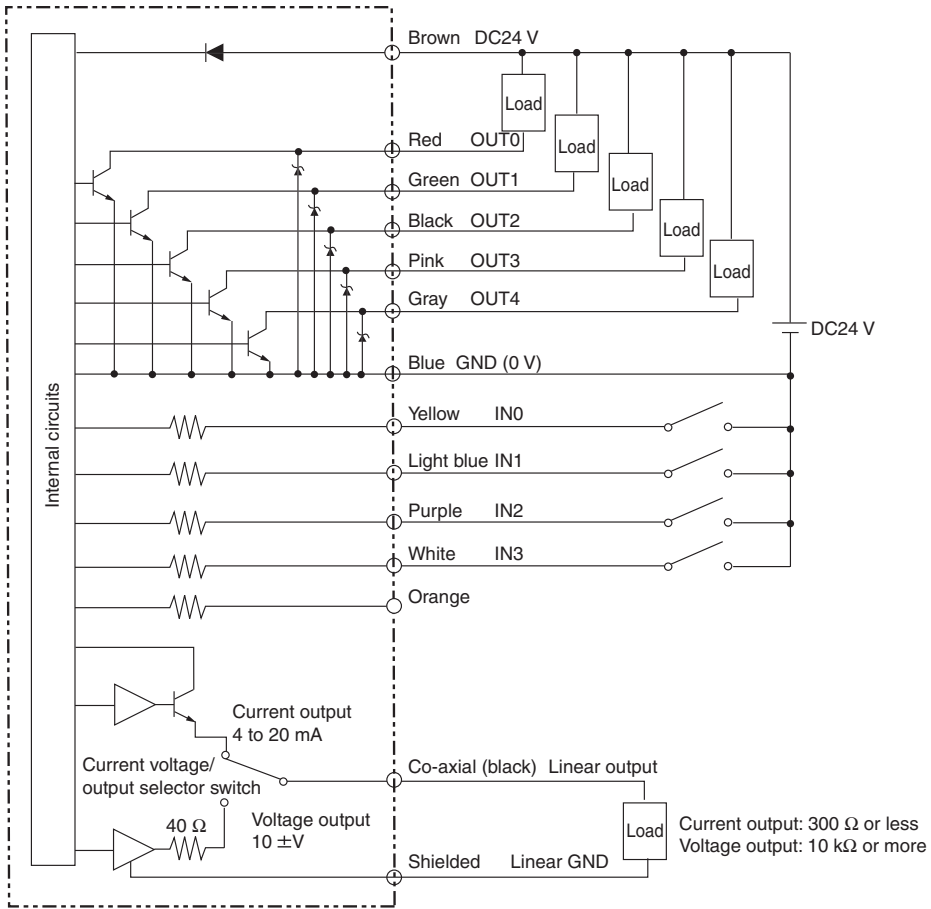

PNP type (ZS-HLDC41)

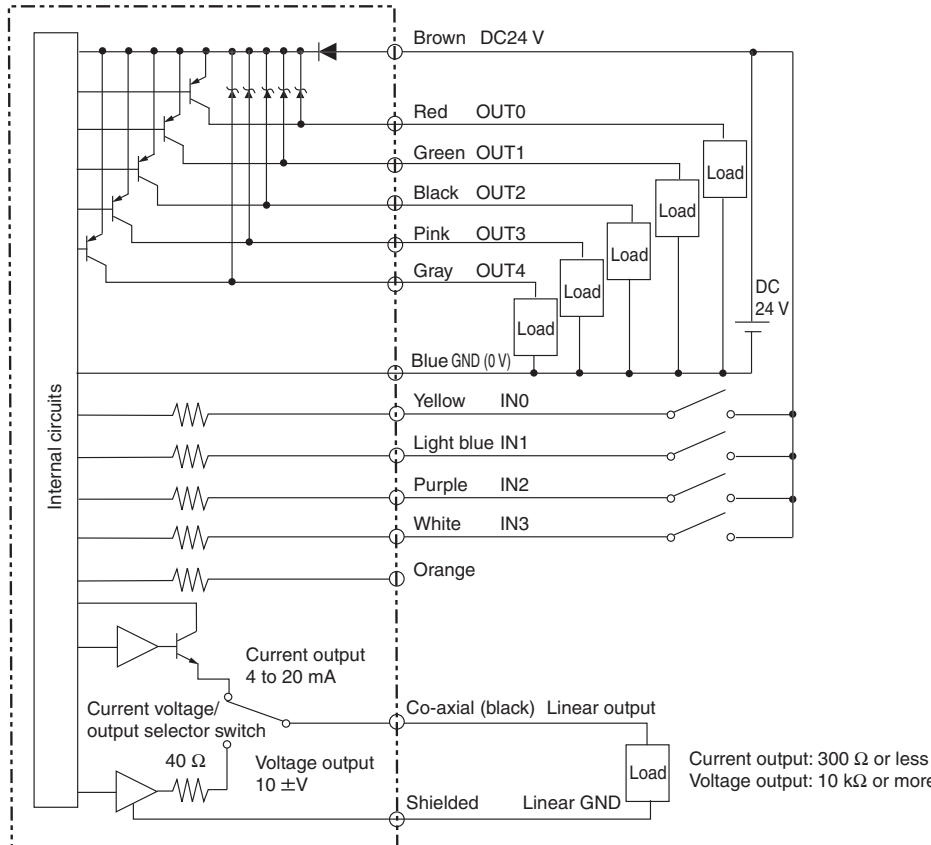

NPN type (ZS-LDC11)

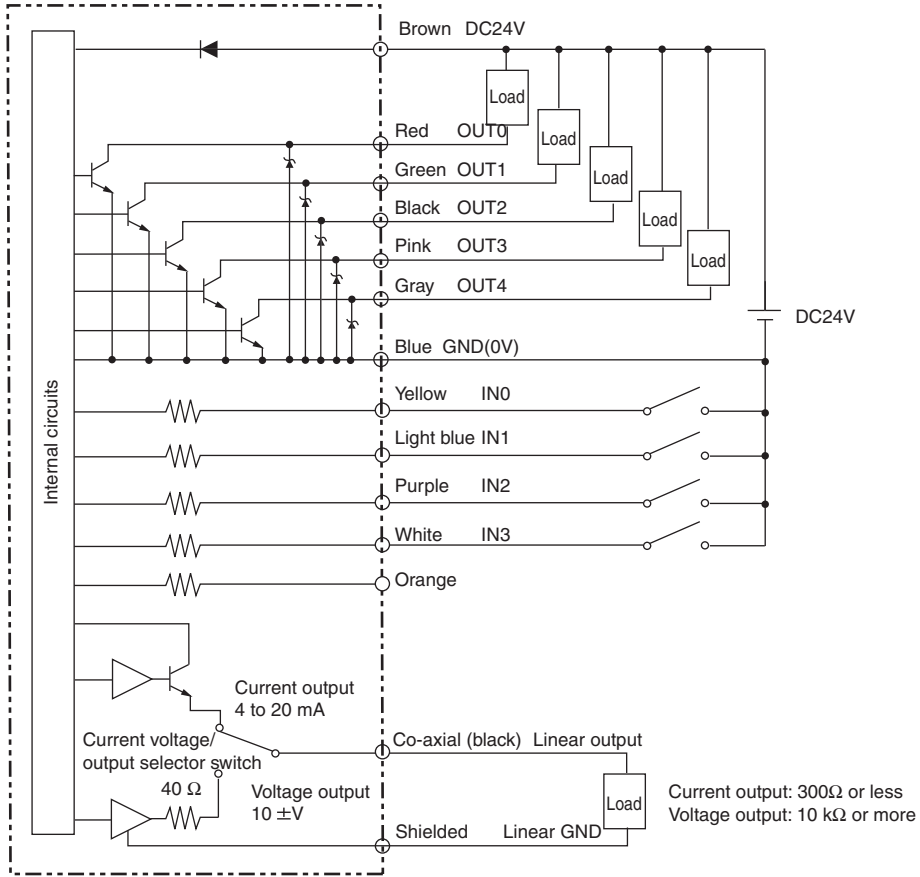

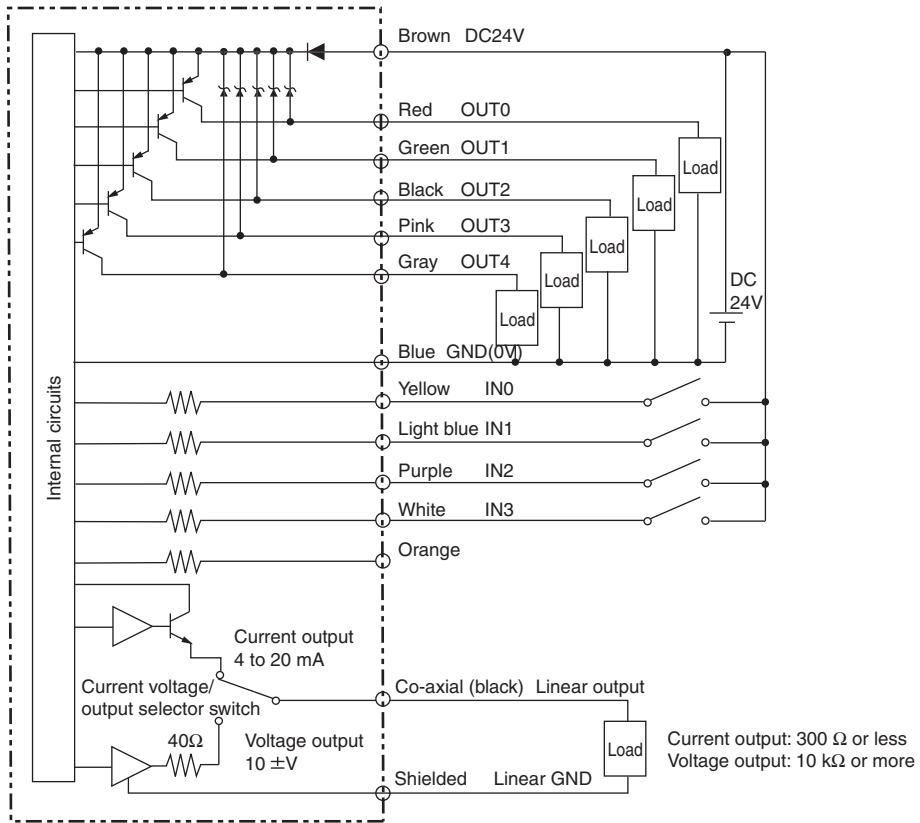

PNP type (ZS-LDC41)



Safety Precautions

⚠ WARNING

This product is not designed or rated for ensuring safety of persons either directly or indirectly. 
Do not use it for such purposes.

Do not expose your eyes to the laser radiation either directly or indirectly (i.e., after reflection from a mirror or shiny surface). 
The laser radiation has a high power density and exposure may result in loss of sight.

Do not disassemble the product. Doing so may cause the laser beam to leak, resulting in the danger of visual impairment. 

Laser Label Indications

Attach the following warning label to the side of the ZS series Sensor Head.



For details, including precautions for correct use, refer to the "ZS-HL Smart Sensor User's manual" (Cat. No. Z236) and "ZS-L Smart Sensor User's manual" (Cat. No. Z208) on your OMRON website.

● For technical information and product FAQs, refer to the "Technical Guide" at your OMRON website.

Dimensions

(Unit: mm)

Sensor Heads

ZS-HLDS2T

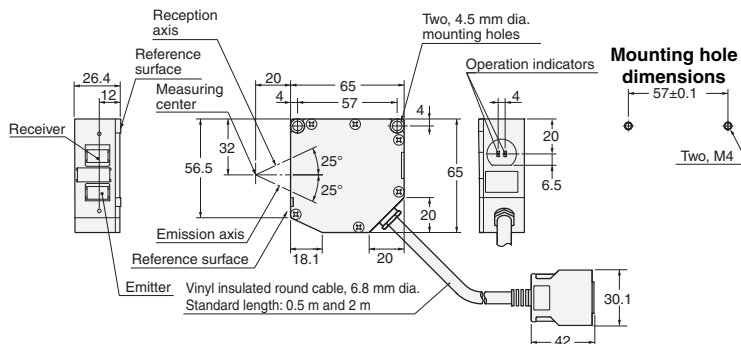

ZS-HLDS5T/HLDS10

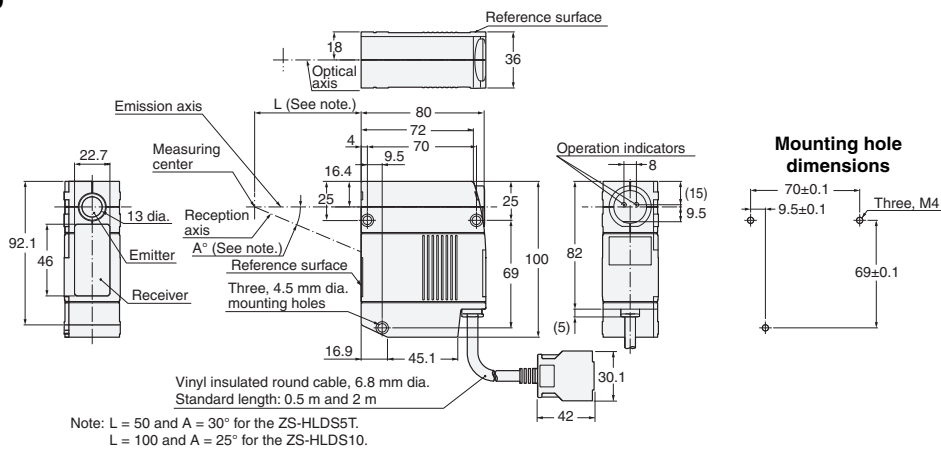

ZS-HLDS60/HLDS150

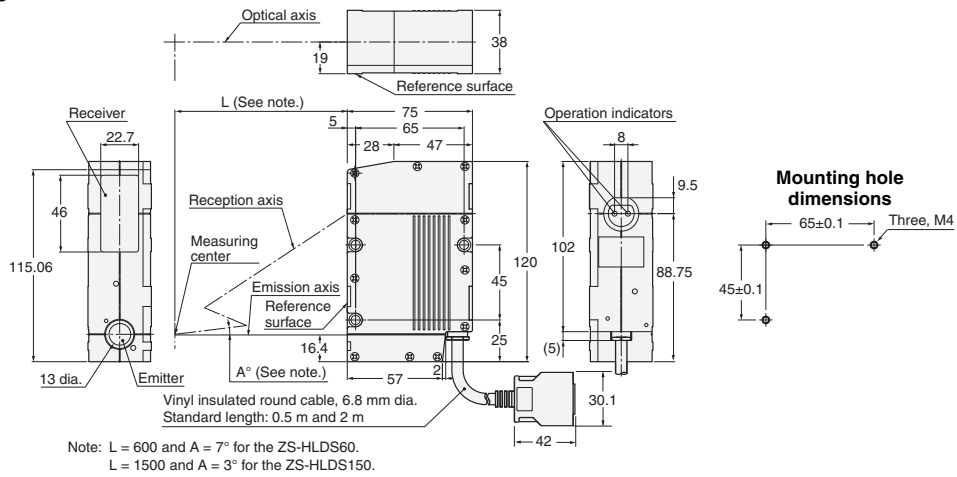

ZS-LD10GT

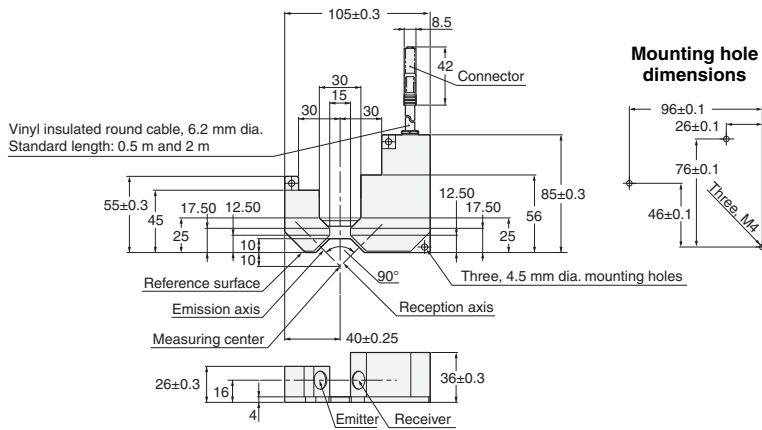

ZS-LD15GT

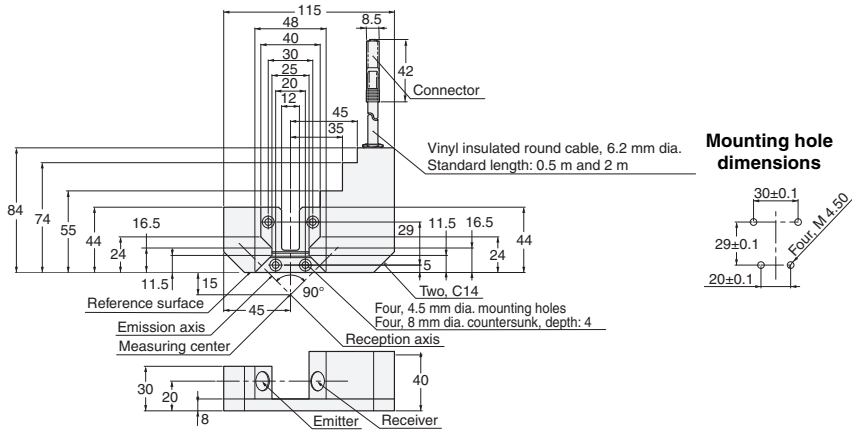

ZS-LD50/LD50S/LD80/LD130/LD200/LD350S

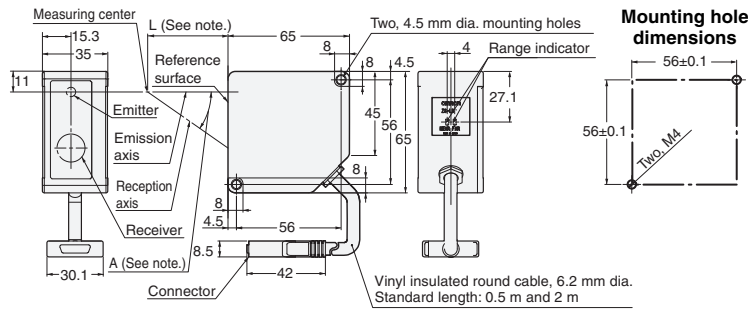

Note: L = 50 and A = 30° for the ZS-LD50/50S.
L = 80 and A = 15° for the ZS-LD80.
L = 130 and A = 12° for the ZS-LD130.
L = 200 and A = 8° for the ZS-LD200.
L = 350 and A = 5° for the ZS-LD350S.

ZS-HLDS2VT/LD20T/LD20ST/LD40T

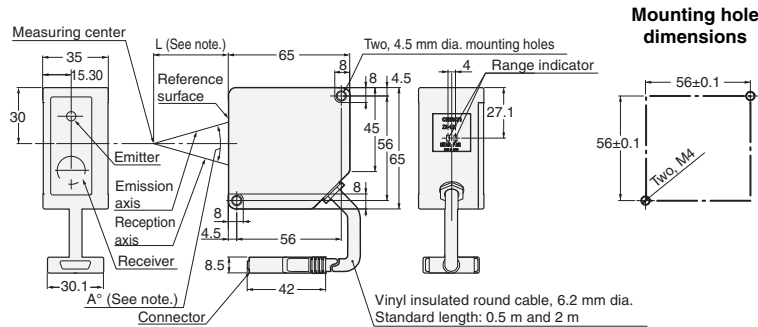

Note: L = 25 and A = 34.5° for the ZS-HLDS2VT.
L = 20 and A = 45° for the ZS-LD20T/20ST.
L = 40 and A = 32° for the ZS-LD40T.

Sensor Controllers
ZS-HLDC□1/LDC□1

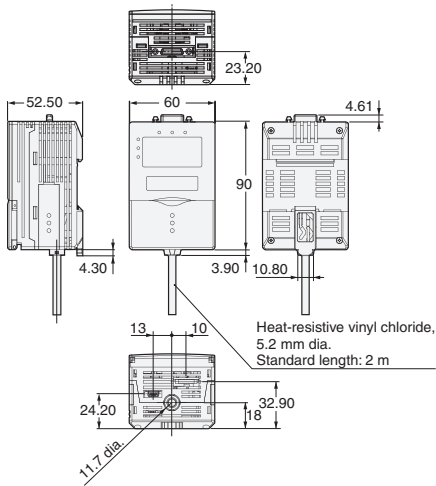

Multi-Controllers
ZS-MDC□1

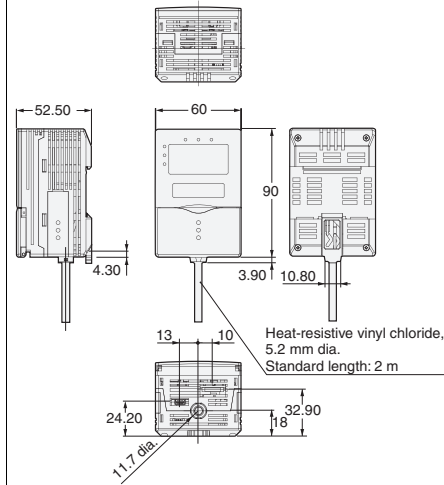

Data Storage Units
ZS-DSU□1

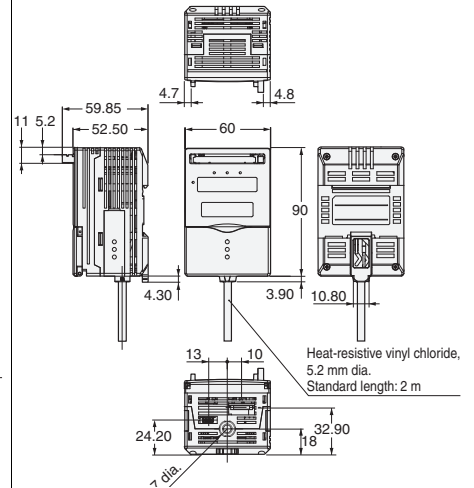

**Realtime Parallel Output Unit
ZG-RPD□1-N**

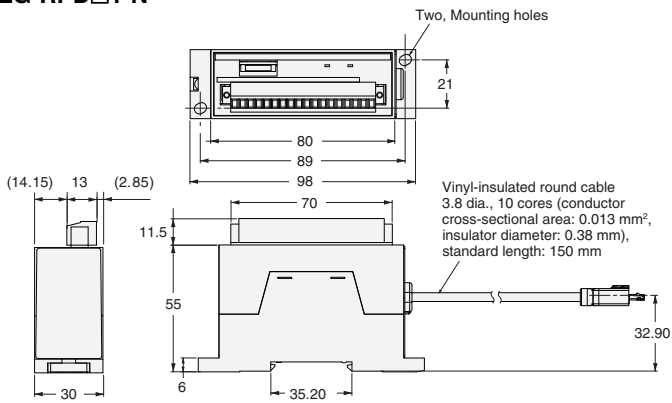

**Panel Mount Adapter
ZS-XPM1/XPM2 (Dimensions for Panel Mounting)**

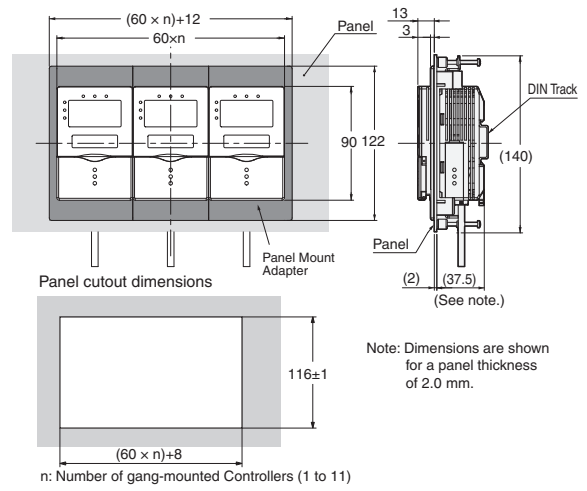

**Digital Equalizer
ZS-XEQ**

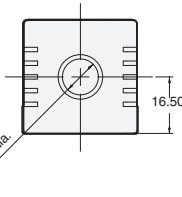
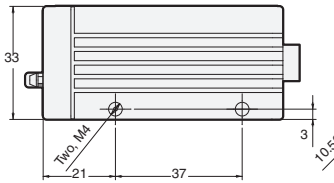
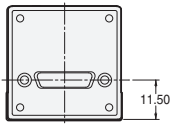
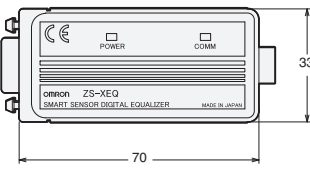
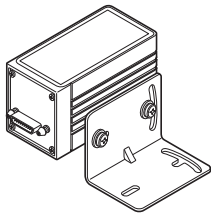

Mounting bracket

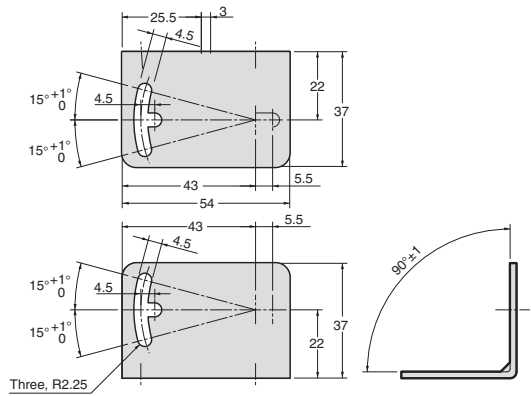

Terms and Conditions Agreement

Read and understand this catalog.

Please read and understand this catalog before purchasing the products. Please consult your OMRON representative if you have any questions or comments.

Warranties.

(a) Exclusive Warranty. Omron's exclusive warranty is that the Products will be free from defects in materials and workmanship for a period of twelve months from the date of sale by Omron (or such other period expressed in writing by Omron). Omron disclaims all other warranties, express or implied.

(b) Limitations. OMRON MAKES NO WARRANTY OR REPRESENTATION, EXPRESS OR IMPLIED, ABOUT NON-INFRINGEMENT, MERCHANTABILITY OR FITNESS FOR A PARTICULAR PURPOSE OF THE PRODUCTS. BUYER ACKNOWLEDGES THAT IT ALONE HAS DETERMINED THAT THE PRODUCTS WILL SUITABLY MEET THE REQUIREMENTS OF THEIR INTENDED USE.

Omron further disclaims all warranties and responsibility of any type for claims or expenses based on infringement by the Products or otherwise of any intellectual property right. (c) Buyer Remedy. Omron's sole obligation hereunder shall be, at Omron's election, to (i) replace (in the form originally shipped with Buyer responsible for labor charges for removal or replacement thereof) the non-complying Product, (ii) repair the non-complying Product, or (iii) repay or credit Buyer an amount equal to the purchase price of the non-complying Product; provided that in no event shall Omron be responsible for warranty, repair, indemnity or any other claims or expenses regarding the Products unless Omron's analysis confirms that the Products were properly handled, stored, installed and maintained and not subject to contamination, abuse, misuse or inappropriate modification. Return of any Products by Buyer must be approved in writing by Omron before shipment. Omron Companies shall not be liable for the suitability or unsuitability or the results from the use of Products in combination with any electrical or electronic components, circuits, system assemblies or any other materials or substances or environments. Any advice, recommendations or information given orally or in writing, are not to be construed as an amendment or addition to the above warranty.

See <http://www.omron.com/global/> or contact your Omron representative for published information.

Limitation on Liability: Etc.

OMRON COMPANIES SHALL NOT BE LIABLE FOR SPECIAL, INDIRECT, INCIDENTAL, OR CONSEQUENTIAL DAMAGES, LOSS OF PROFITS OR PRODUCTION OR COMMERCIAL LOSS IN ANY WAY CONNECTED WITH THE PRODUCTS, WHETHER SUCH CLAIM IS BASED IN CONTRACT, WARRANTY, NEGLIGENCE OR STRICT LIABILITY.

Further, in no event shall liability of Omron Companies exceed the individual price of the Product on which liability is asserted.

Suitability of Use.

Omron Companies shall not be responsible for conformity with any standards, codes or regulations which apply to the combination of the Product in the Buyer's application or use of the Product. At Buyer's request, Omron will provide applicable third party certification documents identifying ratings and limitations of use which apply to the Product. This information by itself is not sufficient for a complete determination of the suitability of the Product in combination with the end product, machine, system, or other application or use. Buyer shall be solely responsible for determining appropriateness of the particular Product with respect to Buyer's application, product or system. Buyer shall take application responsibility in all cases.

NEVER USE THE PRODUCT FOR AN APPLICATION INVOLVING SERIOUS RISK TO LIFE OR PROPERTY OR IN LARGE QUANTITIES WITHOUT ENSURING THAT THE SYSTEM AS A WHOLE HAS BEEN DESIGNED TO ADDRESS THE RISKS, AND THAT THE OMRON PRODUCT(S) IS PROPERLY RATED AND INSTALLED FOR THE INTENDED USE WITHIN THE OVERALL EQUIPMENT OR SYSTEM.

Programmable Products.

Omron Companies shall not be responsible for the user's programming of a programmable Product, or any consequence thereof.

Performance Data.

Data presented in Omron Company websites, catalogs and other materials is provided as a guide for the user in determining suitability and does not constitute a warranty. It may represent the result of Omron's test conditions, and the user must correlate it to actual application requirements. Actual performance is subject to the Omron's Warranty and Limitations of Liability.

Change in Specifications.

Product specifications and accessories may be changed at any time based on improvements and other reasons. It is our practice to change part numbers when published ratings or features are changed, or when significant construction changes are made. However, some specifications of the Product may be changed without any notice. When in doubt, special part numbers may be assigned to fix or establish key specifications for your application. Please consult with your Omron's representative at any time to confirm actual specifications of purchased Product.

Errors and Omissions.

Information presented by Omron Companies has been checked and is believed to be accurate; however, no responsibility is assumed for clerical, typographical or proofreading errors or omissions.