



Main

| | |
|---------------------------------|------------------------------|
| Range of product | Harmony XB4 |
| Product or component type | Head for selector switch |
| Device short name | ZB4 |
| Bezel material | Chromium plated metal |
| Mounting diameter | 22 mm |
| Head type | Standard |
| Sale per indivisible quantity | 1 |
| Shape of signaling unit head | Round |
| Type of operator | Stay put |
| Operator profile | Black long handle |
| Operator additional information | Padlockable |
| Operator position information | 3 positions +/- 45° |
| Locking position | On the left, right or center |

Complementary

| | |
|------------------------------------|--|
| CAD overall width | 29 mm |
| CAD overall height | 38 mm |
| CAD overall depth | 50 mm |
| Net weight | 0.048 kg |
| Resistance to high pressure washer | 7000000 Pa at 55 °C, distance : 0.1 m |
| Mechanical durability | 1000000 cycles |
| Electrical composition code | C3 for <6 contacts using single blocks in front mounting C4 for <6 contacts using single and double blocks in front mounting C5 for <5 contacts using single blocks in front mounting C6 for <5 contacts using single and double blocks in front mounting C7 for <4 contacts using single blocks in front mounting C8 for <4 contacts using single and double blocks in front mounting C11 for <3 contacts using single blocks in front mounting |
| Device presentation | Basic element |

Environment

| | |
|---------------------------------------|---|
| Protective treatment | TH |
| Ambient air temperature for storage | -40...70 °C |
| Ambient air temperature for operation | -40...70 °C |
| Overvoltage category | Class I conforming to IEC 60536 |
| IP degree of protection | IP67 conforming to IEC 60529 IP69 IP69K |
| NEMA degree of protection | NEMA 13 NEMA 4X |
| IK degree of protection | IK06 conforming to IEC 50102 |

| | |
|------------------------|--|
| Standards | JIS C8201-5-1 UL 508 CSA C22.2 No 14 EN/IEC 60947-1 EN/IEC 60947-5-4 EN/IEC 60947-5-1 EN/IEC 60947-5-5 JIS C8201-1 |
| Product certifications | CSA BV DNV LROS (Lloyds register of shipping) UL listed GL |
| Vibration resistance | 5 gn (f= 2...500 Hz) conforming to IEC 60068-2-6 |
| Shock resistance | 30 gn (duration = 18 ms) for half sine wave acceleration conforming to IEC 60068-2-27 50 gn (duration = 11 ms) for half sine wave acceleration conforming to IEC 60068-2-27 |

Packing Units

| | |
|------------------------------|---------|
| Unit Type of Package 1 | PCE |
| Number of Units in Package 1 | 1 |
| Package 1 Height | 3.4 cm |
| Package 1 Width | 4.4 cm |
| Package 1 Length | 5.2 cm |
| Package 1 Weight | 53.0 g |
| Unit Type of Package 2 | S01 |
| Number of Units in Package 2 | 75 |
| Package 2 Height | 15.0 cm |
| Package 2 Width | 15.0 cm |
| Package 2 Length | 40.0 cm |
| Package 2 Weight | 4.2 kg |

Offer Sustainability

| | |
|----------------------------|--|
| Sustainable offer status | Green Premium product |
| REACH Regulation | REACH Declaration |
| REACH free of SVHC | Yes |
| EU RoHS Directive | Pro-active compliance (Product out of EU RoHS legal scope) EU RoHS Declaration |
| Toxic heavy metal free | Yes |
| Mercury free | Yes |
| China RoHS Regulation | China RoHS Declaration |
| RoHS exemption information | Yes |
| Environmental Disclosure | Product Environmental Profile |
| Circularity Profile | End Of Life Information |

Contractual warranty

| | |
|----------|-----------|
| Warranty | 18 months |
|----------|-----------|

Dimensions

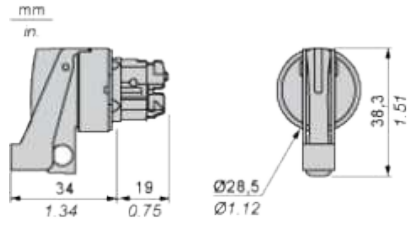

Shank max.: 6.35 mm / 0.25 in.

Panel Cut-out for Pushbuttons, Switches and Pilot Lights (Finished Holes, Ready for Installation)

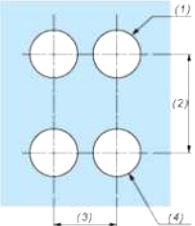
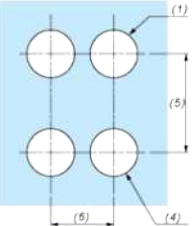
| Connection by Screw Clamp Terminals or Plug-in Connectors or on Printed Circuit Board | Connection by Faston Connectors |
|---|---|
|  |  |
| <p>(1) Diameter on finished panel or support (2) 40 mm min. / 1.57 in. min. (3) 30 mm min. / 1.18 in. min. (4) $\varnothing 22.5$ mm / 0.89 in. recommended ($\varnothing 22.3$ mm $_0^{+0.4}$ / 0.88 in. $_0^{+0.016}$) (5) 45 mm min. / 1.78 in. min. (6) 32 mm min. / 1.26 in. min.</p> | |

Pushbuttons, Switches and Pilot Lights for Printed Circuit Board Connection

Panel Cut-outs (Viewed from Installer's Side)

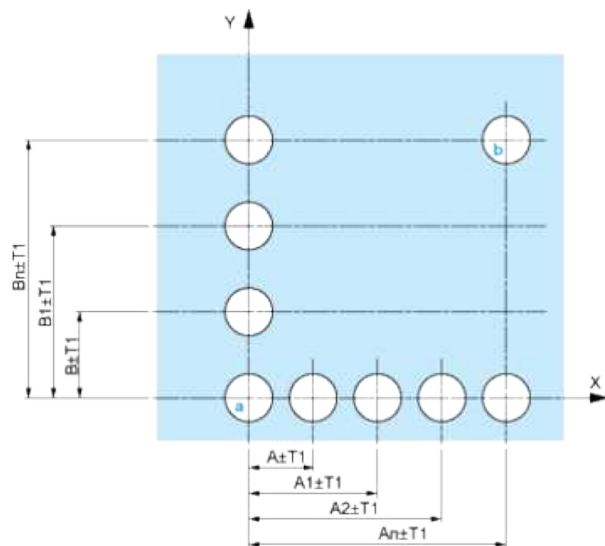

A: 30 mm min. / 1.18 in. min.
 B: 40 mm min. / 1.57 in. min.

Printed Circuit Board Cut-outs (Viewed from Electrical Block Side)

Dimensions in mm

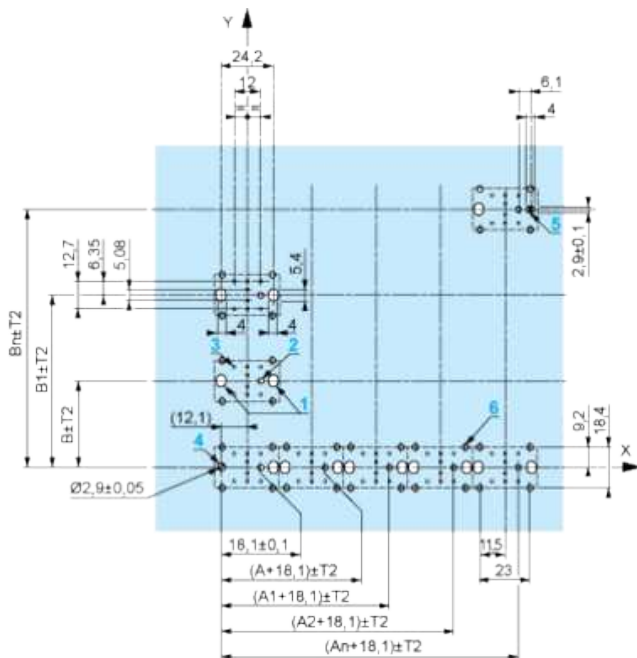

A: 30 mm min.
 B: 40 mm min.
 Dimensions in in.

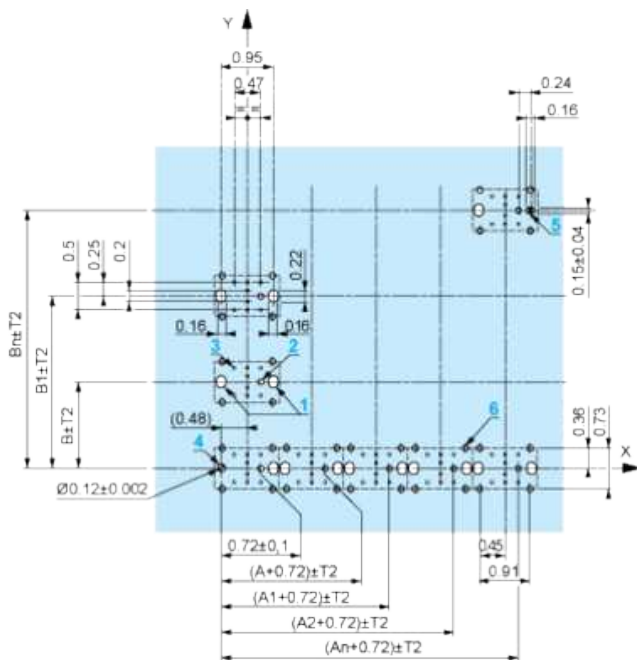

A: 1.18 in. min.
 B: 1.57 in. min.

General Tolerances of the Panel and Printed Circuit Board

The cumulative tolerance must not exceed 0.3 mm / 0.012 in: $T1 + T2 = 0.3 \text{ mm max.}$

Installation Precautions

- Minimum thickness of circuit board: 1.6 mm / 0.06 in.
- Cut-out diameter: 22.4 mm \pm 0.1 / 0.88 in. \pm 0.004
- Orientation of body/fixing collar ZB4 BZ009: $\pm 2^\circ 30'$ (excluding cut-outs marked a and b).
- Tightening torque of screws ZBZ 006: 0.6 N.m (5.3 lbf.in) max.
- Allow for one ZB4 BZ079 fixing collar/pillar and its fixing screws:
 - every 90 mm / 3.54 in. horizontally (X), and 120 mm / 4.72 in. vertically (Y).
 - with each selector switch head (ZB4 BD•, ZB4 BJ•, ZB4 BG•).

The fixing centers marked a and b are diagonally opposed and must align with those marked 4 and 5.

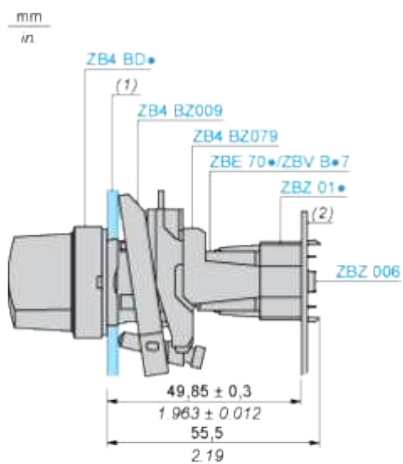

(1) Panel

(2) Printed circuit board

Mounting of Adapter (Socket) ZBZ 01•

- 1 2 elongated holes for ZBZ 006 screw access
- 2 1 hole $\varnothing 2.4 \text{ mm} \pm 0.05 / 0.09 \text{ in.} \pm 0.002$ for centring adapter ZBZ 01•
- 3 8 $\times \varnothing 1.2 \text{ mm} / 0.05 \text{ in.}$ holes
- 4 1 hole $\varnothing 2.9 \text{ mm} \pm 0.05 / 0.11 \text{ in.} \pm 0.002$, for aligning the printed circuit board (with cut-out marked a)
- 5 1 elongated hole for aligning the printed circuit board (with cut-out marked b)
- 6 4 holes $\varnothing 2.4 \text{ mm} / 0.09 \text{ in.}$ for clipping in adapter ZBZ 01•

Dimensions An + 18.1 relate to the $\varnothing 2.4 \text{ mm} \pm 0.05 / 0.09 \text{ in.} \pm 0.002$ holes for centring adapter ZBZ 01•.

Electrical Composition Corresponding to Code C3

Electrical Composition Corresponding to Code C4

Electrical Composition Corresponding to Code C5

Electrical Composition Corresponding to Code C6

Electrical Composition Corresponding to Code C7

Electrical Composition Corresponding to Code C8

Electrical Composition Corresponding to Codes C9, C11, SF1 and SR1

Legend

Single contact

Double contact

Light block

Possible location



Sequence of Contacts Fitted to 3-position Selector Switch Body

Position 315°



| | | | | | |
|----------|----------|------|--------|--------|------|
| Push | Position | Top | | | |
| Bottom | | | | | |
| Location | | Left | Centre | Right | |
| State | | 1 | 1 | 0 | |
| Contacts | N/O | | closed | closed | open |
| N/C | | open | open | closed | |

Position 0°



| | | | | | |
|----------|----------|--------|--------|--------|------|
| Push | Position | Top | | | |
| Bottom | | | | | |
| Location | | Left | Centre | Right | |
| State | | 0 | 0 | 0 | |
| Contacts | N/O | | open | open | open |
| N/C | | closed | closed | closed | |

Position 45°



| | | | | | |
|----------|----------|--------|--------|--------|--------|
| Push | Position | Top | | | |
| Bottom | | | | | |
| Location | | Left | Centre | Right | |
| State | | 0 | 1 | 1 | |
| Contacts | N/O | | open | closed | closed |
| N/C | | closed | open | open | |