

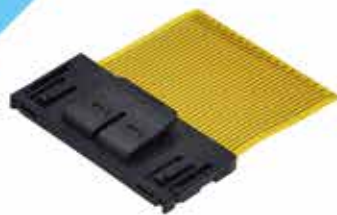

ZConnect

Product Catalogue



FPC



Wire-to-Board



FFC

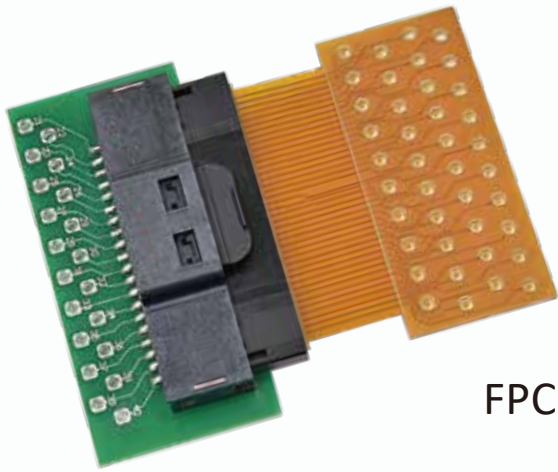

Socket

FPC

- LV214 (VW75174) Compliant
- Anti-Vibration
- Audible Feedback
- Multiple Contacts
- FPC, FFC, Wire-to-Board
- Low Profile
- Cost and Space Saving
- Improved Assembly Efficiency

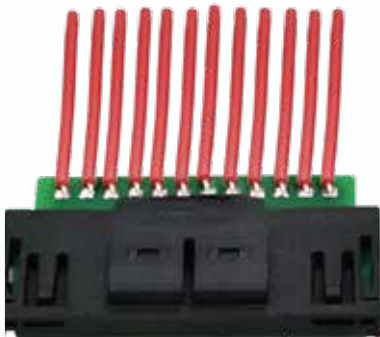

Wire

More Options

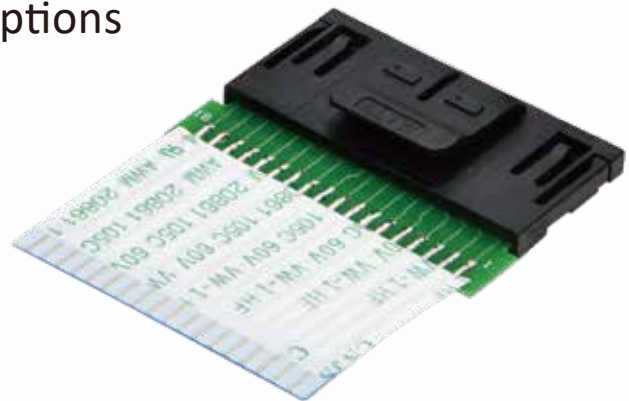

FFC

Watch Video



Youku



Youtube

Contents

1	Product Selection Guide
11	Served Markets & Applications
15	Our Service
21	Markets / Applications
22	Product Range Overview
22	Contact Configuration / Assembly Instruction
23	Ordering Information
24	ZConnect Socket
25	ZConnect Plug
26	Cable List
29	UL Style
35	FAQ and Lexicon



Space Saving



Audible Feedback



Anti-Vibration



UL 94-V0



IEC Standard



Harsh Environment

PRODUCT SELECTION GUIDE

Circular (Ceres, X-Lok, M)

	Mating Style						Materials	No. of Contacts	Contacts		Operating Voltage (AC/DC)	Nominal Current	Applicable Wires (AWG)	Mating Cycles (Pin Contact)	High Speed		Salt Spray (Connector Mated)
	2 Points Lock	3 Points Lock	Push Lock	Push Pull	Screw Thread	Others			Gold Plated	Silver Plated					Cat. 5e	Cat. 6A	
Ceres Series																	
Mini	•				•		B	2-6	•		250V	2A-5A	26-24	2,000			500h
Standard	•				•		B	2-12	•		250-600V	2A-10A 5A+2A 10A+5A	26-20	2,000			500h
Middle	•	•			•		P	2-18	•	•	250-600V	2A-20A 5A+2A 10A+2A 10A+5A	24-14	2,000			500h
Large	•				•		B	2-22	•	•	250-600V	2A-20A 20A+2A 20A+5A	26-16	2,000			500h
Macro	•						P	31	•		200V	5A	26	2,000			500h
PLD			•				P	2-4	•		250V	5A	26-20	2,000			500h
MAB	•						P	4	•		250V	10A	20	2,000			500h
GBD		•					P	8	•		250V	10A+5A	24-20	2,000			500h
X-LOK Series																	
Mini / LED			•				B	2-33	•		30-630V	0.5A-16A 5A-10A	32-14	1,000	•	•	500h
Standard			•				P	2-8	•		300-600V	10A+5A	26-16	1,000			500h
Middle			•				P	2-12	•	•	300-600V	5A-20A 10A+5A	26-12	1,000			500h
Large			•				B	2-100	•	•	60V (0.5A) 300-600V	0.5A-20A 20A+5A 50A	32-26	1,000			500h
Macro			•				P	4-31	•	•	300-600V	50A+5A	22-8	1,000			500h
M Series																	
M5					•		M	3-4	•		60V	1A	26	1,000			48h
Guided M8 / LED					•	Snap-in	B	2-6	•		30-60V	1.5A-3A 3A+1.5A	24-22	1,000			48h
M8 / LED					•	Snap-in	B	3-13	•		30-60V	0.5A-3A	32-22	1,000			48h
M10.5					•		M	2-5	•		30V	2A	24	1,000			48h
M12 A / LED			•	•			B	3-28	•		30-250V	0.5A-4A	30-22	1,000	•		48h
M12 B / LED			•	•			B	5	•		60V	4A	26-22	1,000			48h
M12 D / LED			•	•			B	4	•		250V	4A	26-22	1,000	•		48h
M12 I			•	•			B	5	•		60V	4A	22	1,000			48h
M12 K / LED			•	•			B	3-5	•		630V	12A, 16A	14	1,000			48h
M12 L / LED			•	•			B	2-5	•		63V	16A	14	1,000			48h
M12 M / LED			•	•			B	3-6	•		630V	8A	16	1,000			48h
M12 S			•	•			B	3-4	•		630V	12A	16	1,000			48h
M12 T			•	•			B	2-4	•		63V	12A	16	1,000			48h
M12 X			•	•			M	8	•		30-60V	0.5A	26	1,000		•	48h
M23					•		M	6	•		600V	28A	14-12	1,000			48h

Remarks:
Materials: P (Plastic), M (Metal), B (Both)
Assemble Style: R0 (Receptacle), RW (Receptacle With Wires), RP (Receptacle With Pigtail), RC (Receptacle With Overmolded Cable), OC (Overmolded With Cables), FI (Field Installable)
Vibration: (1) 10-500 Hz @Amplitude 0.35mm; (2) 10-55Hz @Amplitude 1.52mm
Operation Temperature & IP Rating: R0 (Receptacle), RW (Receptacle With Wires), OC (Overmolded With Cables), FI (Field Installable)

PRODUCT SELECTION GUIDE

Circular (FLOS, Power, RBL, DeepTronica)

	Mating Style						Materials	No. of Contacts	Contacts		Operating Voltage (AC/DC)	Nominal Current	Applicable Wires (AWG)	Mating Cycles (Pin Contact)	Salt Spray (Connector Mated)
	2 Points Lock	3 Points Lock	Push Lock	Push Pull	Screw Thread	Others			Gold Plated	Silver Plated					
FLOS Series															
B				•			M	2-32	•		160-700V	1.5A-25A	28-16	5,000	144h
K				•			M	2-32	•		160-700V	1.5A-25A	28-16	5,000	144h
K (FLOS+)				•			M	2-32	•		160-700V	1.5A-25A	28-16	5,000	1000h
C				•			M	2-19	•		160-700V	1.5A-20A	28-16	3,000	144h
S				•			M	1	•		260-1000V	15A	28-16	3,000	144h
Y				•		Break Away	M	2-26	•		260-1000V	5A-14A	28-16	5,000	96h
P				•			P	2-14	•		200-400V	2A-10A	28-16	2,000	
N				•			M	2-19	•		200-800V	5A-22A	28-16	3,000	144h
Power Series															
PWE					•		P	5-7	•		277V	8A	20-17	500	500h
PWF					•		P	2-4	•		277V	12A	18-15	500	500h
PWG					•		P	4	•		277V	16A	18-14	500	500h
PWC	•	•					P	3	•		277V	20A	14-12	500	500h
PWCU	•	•					P	4 & 12	•		277V	20A+2A	14-12, 24-22	500	500h
PWH		•			•		P	3, 5	•		660V (AC) 1000V (DC)	25A	12	500	500h
PWL		•					P	3	•		300V	30A	14-8	500	500h
PWM		•					P	2	•		600V	50A	9-8	500	720h
PWMU		•					P	2+2, 2+4	•		600V	50A+2A	9-8, 22-20	500	720h
PWN		•					P	2	•		600V	70A	8-6	500	720h
PWNU		•					P	2+2, 2+4	•		600V	70A + 2A	8-6, 22-20	500	720h
PWP		•					P	2 & 3	•		600V	80A	4	500	720h
PWPD		•					P	2+2, 2+4, 3+2, 3+4	•		600V	80A+5A	4, 20	500	720h
PWX		•					P	9 (30A) 14 (30A+5A) 5 (50A) 12 (50A+5A) 4 (80A) 7 (80A+5A)	•		300-600V	30A, 30A+5A 50A, 50A+5A 80A, 80A+5A	22-20, 14-8, 9-8, 4	500	720h
RBL Series															
Middle			With Latch				P	2-9	•		300V	5A-10A 10A+5A	20-16	250	48h
Large			With Latch				P	2-18	•		300V	5A-20A 20A+5A	24-12	250	48h
DeepTronica															
Bathypelagic (4,000 m)				•			B								
Abyssopelagic (6,000 m)				•			B	1-27			200V-1000V	2A-50A	22-8	500-1,000	1000h
Hadopelagic (11,000 m)				•			B								

Remarks:
Materials: P (Plastic), M (Metal), B (Both)
Assemble Style: RO (Receptacle), RW (Receptacle With Wires), RP (Receptacle With Pigtail), RC (Receptacle With Overmolded Cable), OC (Overmolded With Cables), FI (Field Installable)
Vibration: (1) 10-500 Hz @Amplitude 0.35mm; (2) 10-55Hz @Amplitude 1.52mm
Operation Temperature & IP Rating: RO (Receptacle), RW (Receptacle With Wires), OC (Overmolded With Cables), FI (Field Installable)

PRODUCT SELECTION GUIDE

Circular (HS-Lok, NMEA 2000, Mini, Heavy Duty Shielded)

	Mating Style						Materials	No. of Contacts	Contacts		Operating Voltage (AC/DC)	Nominal Current	Applicable Wires (AWG)	Mating Cycles (Pin Contact)	Salt Spray (Connector, Mated)
	2 Points Lock	3 Points Lock	Push Lock	Push Pull	Screw Thread	Others			Gold Plated	Silver Plated					
HS-Lok Series															
Q8				•			B	2-6	•		100V (DC), 300V, 300V (AC) + 100V (DC)	2A, 5A, 5A+2A	24-20	2,000	500h
NMEA 2000															
Lite (Micro)				•	•		B	5	•		60V	4A	16*1P+20*1P 18*1P+22*1P 22*1P+24*1P	Push Pull 500, Screw Thread 1,000	Metal: 48h Plastic: 1,000h
Heavy (Mini)					•		M	4-5	•		600V	8A	15*1P+18*1P 16*1P+18*1P	1,000	
7/8" Mini															
7/8" Mini					•		M	2, 2+PE, 4, 4+PE, 6	•		600V	8A-13A	16	1,000	48h
Heavy Duty Shielded															
Heavy Duty Shielded					*		M	2-14	•		50-300V	5A-40A	22-8	1,000	48h / 500h

Remarks:
Materials: P (Plastic), M (Metal), B (Both)
Assemble Style: R0 (Receptacle), RW (Receptacle With Wires), RP (Receptacle With Pigtail), RC (Receptacle With Overmolded Cable), OC (Overmolded With Cables), FI (Field Installable)
Vibration: (1) 10-500 Hz @Amplitude 0.35mm; (2) 10-55Hz @Amplitude 1.52mm
Operation Temperature & IP Rating: R0 (Receptacle), RW (Receptacle With Wires), OC (Overmolded With Cables), FI (Field Installable)

PRODUCT SELECTION GUIDE

(RO) Receptacle				(FI) Field Installable					OC	UV Resistant	UL 94V-0	Vibration	EMI Option	ROHS 2.0 & REACH	Certifications	IP Rating	Operating Temperature
Solder	PCB 180	PCB 90	RW	Solder	Crimp	Screw In	Push In	IDC									
•				•					•	•	(2)		•	UL2238, UL50e	RO: IP68 (Unmated) OC: IP68 (Mated) FI: IP68 (Mated)	◦ RO: -40°C - 105°C ◦ OC: -40°C - 105°C ◦ FI: -40°C - 105°C	
•	•		•	•		•	•		•		(1)		•	NMEA 2000	RO: IP68 (Unmated) RW: IP68 (Unmated) OC: IP68 (Mated)	◦ RO: -40°C - 105°C ◦ RW: -20°C - 85°C ◦ OC: -20°C - 85°C	
•	•					•	•		•		94-HB	(1)	•	NMEA 2000	FI: IP67 (Mated)	◦ FI: -40°C - 105°C	
•	•		•	•	•	•			•			(1)			RO: IP68 (Unmated) RW: IP68 (Unmated) OC: IP68 (Mated) FI: IP67 (Mated)	◦ RO: -40°C - 105°C ◦ OC: -40°C - 105°C ◦ FI: -40°C - 105°C	
•				•					•	•	94-HB	(1)	•		RO: IP68 (Unmated) OC: IP68 (Mated) FI: IP68 (Mated)	◦ RO: -40°C - 105°C ◦ RW: -20°C - 85°C ◦ OC: -20°C - 85°C ◦ FI: -40°C - 105°C	

PRODUCT SELECTION GUIDE

Other IO (RJ45, USB, D-Sub, SSL, HDMI, DVI)

	Mating Style			Materials	No. of Contacts	Gold Plated	Operating Voltage (AC/DC)	Nominal Current	Applicable Wires (AWG)	Mating Cycles (Pin Contact)	High Speed			
	2 Points Lock	3 Points Lock	Push Lock								Screw Thread	Others	Cat. 5e	Cat. 6A
RJ45 Series														
Middle		•		•	B	8		44-57V (DC)	Max. 1.5A	24	750	•	•	
Large / I-Adaptor	•	•		•	P	8		44-57V (DC)	Max. 1.5A	24	750	•		
ODVA	•				P	8		44-57V (DC)	Max. 1.5A	24	750	•		
Self-Closing Cover					P	8		44-57V (DC)	Max. 1.5A		750	•	•	
USB Series														
Mini USB Type B				•	P		•	30V	1.5A	28*1P + 28*3C	5,000			
Type A	•			•	B		•	30V	USB 2.0: 1.5A USB 3.2Gen1:	28*1P + 24*2C	1,500			
Type B	•			•	B		•	30V	USB 2.0: 1.5A	28*1P + 24*2C	1,500			
Micro USB Swift					M		•	30V (AC) 5V (DC)	1 & 5 Pin: 1.8A 2, 3 & 4 Pin: 1A		10,000			
Micro USB Swift-MU					P		•	30V (AC) 5V (DC)	1 & 5 Pin: 1.8A 2, 3 & 4 Pin: 1A	28	10,000			
Type C Swift-LP					M		•	30V (DC)	Up To 5A	32*1P + 24*1C + 28*1D	10,000			
Type C Swift-LA					P		•	30V (DC)	Up To 3A	32*1P + 24*1C + 28*1D	10,000			
Type C Swift-GG				•	B		•	30V (DC)	Up To 5A	32*1P + 24*1C + 28*1D	10,000			
Type C Swift-XL			•		P		•	30V (DC)	Up To 3A	32*1P + 24*1C + 28*1D	10,000			
D-SUB Series														
Standard				•	Automated Latch	M	9, 15, 25, 37, 50*	•	125V (DC)	5A	24	500		
High Density				•	Automated Latch	M	15, 26, 44, 62*, 78*	•	125V (DC)	2A	26	500		
SSL Series														
SSL1.1			•		P	2-6		•	100V	3A	22	100		
SSL1.2			•		P	2-4		•	250V	5A	22-18	30		
SSL1.3					P	1		•	500V	5A		10		
SSL2.1					P	2		•	600V	12A		20		
SSL2.3					P	2		•	500V	3A		100		
HDMI Series														
Circular				•		P	19	•	30V (AC)	0.5A	26	500		
Rectangular			•		With Latch	P	19	•	30V (AC)	0.5A	26	500		
Mini-HDMI				•		P	19	•	30V (AC)	0.5A	30	500		
DVI Series														
DDD					M	25		•	40V (AC)	1.5A	28	100		
DDS					M	19		•	40V (AC)	1.5A	28	100		
DID					M	29		•	40V (AC)	1.5A	28	100		
DIS					M	23		•	40V (AC)	1.5A	28	100		

Remarks:
Materials: P (Plastic), M (Metal), B (Both)
Assemble Style: RO (Receptacle), RW (Receptacle With Wires), RP (Receptacle With Pigtail), RC (Receptacle With Overmolded Cable), OC (Overmolded With Cables), FI (Field Installable)
Vibration: (1) 10-500 Hz @Amplitude 0.35mm; (2) 10-55Hz @Amplitude 1.52mm
Operation Temperature & IP Rating: RO (Receptacle), RW (Receptacle With Wires), OC (Overmolded With Cables), FI (Field Installable)

PRODUCT SELECTION GUIDE

High Speed			Salt Spray (Connector, Mated)	RO	RW	RP	OC	FI	UV Resistant	UL 94V-0	Vibration	EMI Option	ROHS 2.0 & REACH	Standard / Compliant / Certifications	Operating Temperature & IP Rating
USB 2.0	USB 3.2 Gen1	USB 3.2 Gen2													
			48h	PCB 90 & 180, Jack 90 & 180			•	•	•	•	(2)	•	•	TIA/EIA-568, IEC 60603-7	◦ RO : -40°C - 105°C, IP67 (Unmated)
			48h	PCB180, Jack 90 & 180			•	•	•	•	(2)	•	•	TIA/EIA-568, IEC 60603-7	◦ RP : -20°C - 85°C, IP67 (Unmated) ◦ OC : -20°C - 85°C, IP67P (Mated)
			48h	Jack 180			•	•	•	•	(2)	•	•	TIA/EIA-568, IEC 60603-7	◦ FI : -40°C - 105°C, IP67 (Mated)
			48h	•					•	•	(2)	•	•	TIA/EIA-568, IEC 60603-7	-40°C - 105°C, IP67 (Unmated)
•			48h	•	•					94V-HB	(2)	•	•		◦ RO : -40°C - 105°C, IP67 (Unmated)
•	•		48h	Type 1 & 2, Jack, PCB 180	•		•			•	(2)	•	•		◦ RW : -20°C - 85°C, IP67 (Unmated)
•			48h	Type 1 & 2, Jack, PCB 180	•		•			•	(2)	•	•		◦ OC : -20°C - 85°C, IP67P (Mated) ◦ FI : -40°C - 105°C, IP67 (Mated)
•			48h	•						•	(2)	•	•		-30°C - 80°C, IP67/IP68 (Unmated)
•			48h				•			•	(2)	•	•		-40°C - 80°C, IP67 (Mated)
		•	48h	•						•	(2)	•	•		-40°C - 85°C, IP67 (Unmated)
•	•		48h	•			•			•	(2)	•	•		◦ RO : -40°C - 85°C, IP68 (Unmated)
	•	•	48h	•			•			•	(2)	•	•		◦ OC : -20°C - 85°C, IP67 (Mated)
	•		48h	•			•			•	(2)	•	•		◦ RO : -40°C - 85°C, IP67 (Unmated)
	•		48h	•			•			•	(2)	•	•		◦ OC : -20°C - 85°C, IP67 (Mated)
			8h	Solder, PCB 90& 180			•				(2)	•	•		◦ RO : -40°C - 105°C, IP68 (Unmated)
			8h	Solder, PCB 90& 180			•				(2)	•	•		◦ OC : -20°C - 85°C, IP67P (Mated) ◦ FI : -40°C - 105°C, IP67 (Mated)
				•			•			•	(2)		•	CSA C22.2, UL1977	-40°C - 105°C, Non-IP
				•			•			•	(2)		•	CSA C22.2, UL1977, cUL UL2238+UL50e	-40°C - 105°C, IP68 (Mated)
				•						•	(2)		•	CSA, UL1977	-40°C - 105°C, Non-IP
				•						•	(2)		•	CSA, UL1977	-40°C - 105°C, Non-IP
				•						•	(2)		•		-40°C - 105°C, Non-IP
			48h	•			•			94V-HB	(2)	•	•		◦ RO : -20°C - 85°C, IP67 (Unmated)
			48h	•			•			94V-1	(2)	•	•		◦ OC : -20°C - 85°C, IP67P (Mated)
			48h	•			•			•	(2)	•	•		
			8h	•			•				(2)		•		◦ RO : -40°C - 105°C, IP68 (Unmated)
			8h	•			•				(2)		•		◦ OC : -20°C - 85°C, IP67P (Mated)
			8h	•			•				(2)		•		
			8h	•			•				(2)		•		

PRODUCT SELECTION GUIDE

Other IO (Fiber, ZConnect, RF)

	Mating Style			Materials	No. of Contacts	Gold Plated	Operating Voltage (AC/DC)	Nominal Current	Applicable Wires (AWG)	Mating Cycles (Pin Contact)	High Speed	
	2 Points Lock	3 Points Lock	Push Lock								Screw Thread	Others
Fiber Optic Series												
LC		•										
SC		•										
ZConnect Series												
FPC / FFC / WTB				Quick Plug	B	40, 36, 20, 18, 12	•	120V	1A		10	
RF Series												
SMA Type					M	1	•	335 Volts RMS At Sea Level		1.13mm, 1.32mm, 1.37mm, RG178	500	
N Type					M	1	•	1,000 Volts RMS At Sea Level		1.13mm, 1.32mm, 1.37mm, RG142, RG178, G58 A/U	500	

Other (Cable Joiner, Cable Gland, Protective Vent, LED)

	Mating Style		Materials	No. of Contacts	Contacts				Operating Voltage (AC/DC)	Nominal Current	Applicable Wires (AWG)	Salt Spray (Connector, Mated)	Receptacle
	Push Lock With Latch	Screw Thread			Gold Plated	Nickel Plated	Thermo plastic	SUS316L					
Cable Joiner Series													
M20		•	P	None, 4	•				10A	22-16			
M32	•		P	None, 4	•				15A-30A	16-10			
FICX I Tube (11)		•	P	2-5		•		450V (Non-UL) 600V (UL)	10A-30A	20-12			
FICX I Tube (12)		•	P	2-5		•		450V (Non-UL) 600V (UL)	8A-20A	18-12			
FICX XI Tube (13)		•	P	2-5		•		450V (Non-UL) 600V (UL)	8A-20A	18-12			
FICX T Tube (T2)		•	P	2-5		•		450V (Non-UL) 600V (UL)	10A-20A	20-12			
Cable Gland Series													
Cable Gland		•	B									•	
Protective Vent													
M6 Plastic		•	P								1,000h	•	
M12 Snap-in		•	P								1,000h	•	
M12 Stainless		•	M				•				1,000h	•	
M12 Plastic		•	P				•				1,000h	•	
M12 Metal		•	M			•					48h	•	
LED Light Guide													
Ø3mm			B				•	4V				•	
Ø5mm			M				•	4V				•	

Remarks:
Materials: P (Plastic), M (Metal), B (Both)
Assemble Style: R0 (Receptacle), RW (Receptacle With Wires), RP (Receptacle With Pigtail), RC (Receptacle With Overmolded Cable), OC (Overmolded With Cables), FI (Field Installable)
Vibration: (1) 10-500 Hz @Amplitude 0.35mm; (2) 10-55Hz @Amplitude 1.52mm
Operation Temperature & IP Rating: R0 (Receptacle), RW (Receptacle With Wires), OC (Overmolded With Cables), FI (Field Installable)

PRODUCT SELECTION GUIDE

USB 2.0	High Speed		Salt Spray (Connector, Mated)	RO	RW	RP	OC	FI	UV Resistant	UL 94V-0	Vibration	EMI Option	ROHS 2.0 & REACH	Standard / Compliant / Certifications	Operating Temperature & IP Rating
	USB 3.2 Gen1	USB 3.2 Gen2													
			48h	•				•	•						-40°C - 105°C, IP67 (Mated)
			48h	•				•	•						-40°C - 105°C, IP67 (Mated)
			48h						•				•		-40°C - 110°C, Non-IP
			48h	•								•	•	MIL-C-39012	-40°C - 105°C, IP68 (Unmated)
			48h	•								•	•	MIL-C-39012	-40°C - 105°C, IP68 (Unmated)

Field Installable	UV Resistant	UL 94V-0	Vibration	ROHS 2.0 & REACH	Certifications	IP Rating	Operating Temperature
•	•	94V-2		•		IP67	-40°C - 105°C
•	•	•		•	UL6703A	IP67	-40°C - 105°C
•	•	•		•	CSA, UL2238, UL50e	IP68 (Mated)	-40°C - 105°C
•	•	•		•	CSA, UL2238, UL50e	IP68 (Mated)	-40°C - 105°C
•	•	•		•	CSA, UL2238, UL50e	IP68 (Mated)	-40°C - 105°C
•	•	•		•	CSA, UL2238, UL50e	IP68 (Mated)	-40°C - 105°C
•		94V-0 94V-2	(2)	•		IP67 (Mated) IP68 (Mated)	• RO: -20°C - 105°C • FI: -20°C - 105°C
	•	•		•		IP66, IP68	-40°C - 125°C
	•	•		•		IP68, IP69K	-40°C - 125°C
	•	•		•		IP68, IP69K	-40°C - 125°C
	•	•		•		IP68, IP69K	-40°C - 125°C
	•	•		•		IP68, IP69K	-40°C - 125°C
						IP67	• Red & Green: -30°C - 80°C • Others: -40°C - 80°C
						IP67	• Red & Green: -30°C - 80°C • Others: -40°C - 80°C

Served Markets & Applications

Applications	Ceres	X-Lok	M series	FLOS & FLOS+	Power	RBL	Deep Tronica	HS-Lok	NMEA 2000	7/8" Mini	Heavy Duty Shielded	RJ45	USB	SSL	HDMI	DVI	Fiber Optics	Zconnect	RF	Cable Joiner	Cable Gland	Vent	LED Light Guide	D-Sub
LED Lighting																								
Architectural Lighting	•	•	•		•	•		•		•		•		•				•		•	•	•		
Outdoor LED Displays	•	•	•	•	•	•				•		•		•				•		•	•	•		
Outdoor Signage	•	•			•	•				•		•		•				•		•	•	•		
Entertainment Lighting & Systems	•	•			•	•		•		•		•		•				•		•	•	•		
Smart City, Street Lighting	•	•			•	•				•		•		•				•		•	•	•		
Tunnel Lighting	•	•	•		•	•				•		•		•				•		•	•	•		
Parking Lighting	•	•			•	•		•		•		•		•				•		•	•	•		
Cruise & Shipyards Lighting	•	•	•		•	•		•	•	•		•		•				•		•	•	•		
High Speed Train & EV Bus	•	•			•	•		•		•	•		•					•		•	•	•		
Commercial Lighting	•	•	•		•	•		•		•		•		•				•		•	•	•		
Refrigeration Lighting	•	•	•		•	•		•		•		•		•				•		•	•	•		
Horticulture Lighting	•	•	•		•	•				•		•		•				•		•	•	•		
Warehouse Lighting	•	•			•	•				•		•		•				•		•	•	•		
Emergency Lighting	•	•	•		•	•		•		•		•		•				•		•	•	•		
UV and Sanitary Lighting	•	•	•		•	•		•		•		•		•				•		•	•	•		
Li-Fi	•	•			•	•				•		•		•				•	•	•	•	•		
Hospital Surgical Lighting & Room	•	•	•		•	•		•		•		•		•				•		•	•	•		
ATEX Lighting	•	•			•	•		•				•		•				•		•	•	•		
Underwater / Submerged Lighting	•	•			•	•								•				•				•		
Marine																								
Multi-FunctionDisplay	•	•	•	•	•	•			•	•	•	•	•		•	•		•	•		•	•	•	•
Outboard Motors	•	•	•		•	•			•	•	•	•						•			•			
Bilge Pump	•	•	•		•	•			•	•	•	•						•			•			
Heater	•	•	•		•	•		•	•	•	•	•						•		•	•	•		
HVAC (Heating Ventilation Air Conditioning)	•	•	•		•	•		•	•	•	•	•						•		•	•	•		
Fridge	•	•	•		•	•		•	•	•	•	•						•			•			
Docking System	•	•	•		•	•	•		•	•	•	•						•			•			
Windlass	•	•	•		•	•			•	•	•	•						•			•			
Sensors	•	•	•		•	•			•	•	•	•						•			•			
RADAR	•	•	•		•	•		•	•	•	•	•	•					•	•		•			
Antenna	•	•	•		•	•		•	•	•	•	•						•	•		•			
USB Charger	•	•	•		•	•		•	•	•	•	•	•					•		•	•	•		
Audio System	•	•	•		•	•		•	•	•	•	•	•					•		•	•	•		
Lighting System	•	•	•		•	•		•	•	•	•	•	•	•				•		•	•	•		•
CCTV	•	•	•		•	•		•	•	•	•	•	•					•			•			
Power Controller	•	•	•		•	•			•	•	•	•						•		•	•	•		•
Autopilot System	•	•	•		•	•			•	•	•	•						•		•	•	•		•
Automatic Identification System	•	•	•		•	•		•	•	•	•	•						•		•	•	•		•
GPS, Beacon & Lifebuoy	•	•	•		•	•		•	•	•	•	•						•		•	•	•		
Sonar / Transducer	•	•	•		•	•			•	•	•	•						•			•			
Fish-Finders	•	•	•		•	•			•	•	•	•						•			•			
Chartplotter	•	•	•		•	•			•	•	•	•						•			•			•
Sailing Instruments	•	•	•		•	•			•	•	•	•						•			•			•
Shipyards & Cruise	•	•	•		•	•			•	•	•	•						•			•			•
Drilling Systems							•																	
Seaport							•																	
Submarine							•																	
ROVs							•																	
Marine Renewable Energy							•																	
ROTV							•																	
Buoys							•																	
Underwater Vehicles							•																	
Underwater Equipment							•																	
Diving							•																	
Broadband Wireless Access																								
General Small Cells	•	•	•		•	•		•	•	•	•	•					•	•	•	•	•	•	•	•
RRH (Remote Radio Head)	•	•	•		•	•		•	•	•	•	•					•	•	•	•	•	•	•	•
Wireless Mobile Backhaul	•	•	•		•	•		•	•	•	•	•					•	•	•	•	•	•	•	•
High Capacity Mobile Subscriber Unit	•	•	•		•	•		•	•	•	•	•					•	•	•	•	•	•	•	•
Outdoor Base Station Unit	•	•	•		•	•		•	•	•	•	•					•	•	•	•	•	•	•	•
Outdoor LTE	•	•	•		•	•		•	•	•	•	•					•	•	•	•	•	•	•	•
Outdoor AP	•	•	•		•	•		•	•	•	•	•					•	•	•	•	•	•	•	•
Subscriber Station	•	•	•		•	•		•	•	•	•	•					•	•	•	•	•	•	•	•
Outdoor Wireless Mesh Router	•	•	•		•	•		•	•	•	•	•					•	•	•	•	•	•	•	•
Base Station Power Supply	•	•		•	•	•		•	•	•	•	•					•	•	•	•	•	•	•	•
Communication System																		•						
Outdoor Wireless Mesh Router	•	•			•	•		•	•	•	•	•					•	•	•	•	•	•	•	•

Served Markets & Applications

Applications	Ceres	X-Lok	M series	FLOS & FLOS+	Power	RBL	Deep Tronica	HS-Lok	NMEA 2000	7/8" Mini	Heavy Duty Shielded	RJ45	USB	SSL	HDMI	DVI	Fiber Optics	Zconnect	RF	Cable Joiner	Cable Gland	Vent	LED Light Guide	D-Sub	
Industrial Automation																									
Robotic Arm			•	•				•		•	•							•							
Industrial Server / Network	•	•	•	•	•			•		•	•	•	•		•	•	•	•	•			•	•	•	•
Industrial Forklifts (Truck)	•	•	•	•	•	•		•		•	•	•	•		•	•					•	•		•	•
AVI (Automatic visual inspection)	•	•	•	•	•			•		•	•														
Data Communication System	•	•	•	•	•	•		•		•	•	•	•		•	•			•	•			•	•	•
Industrial Control Center	•	•	•	•	•	•		•		•	•	•	•		•	•						•	•	•	•
Packaging Center	•	•	•	•	•			•		•	•														
Conveyors	•	•	•	•	•			•		•	•														
Sensors			•							•	•								•						
Power Distribution	•	•	•	•	•	•				•	•								•						
Actuators	•	•	•							•	•								•						
Motor Drives	•	•	•		•	•				•	•								•						
Industrial PC & Displays	•	•	•	•	•	•		•		•	•	•	•		•	•			•	•			•	•	•
Machine Tools	•	•	•	•	•	•				•	•								•						
Switches		•	•							•	•	•	•						•						•
Production Equipment	•	•	•	•	•	•				•	•	•	•						•				•	•	•
Renewable Energy																									
PV / DC Inverter	•	•	•		•	•				•	•	•							•		•	•	•	•	•
Micro Inverter																			•		•	•	•	•	•
CSP & CPV	•	•	•		•	•				•	•								•		•	•	•	•	•
Heliostat	•	•	•		•	•				•	•								•		•	•	•	•	•
PV Trackers	•	•	•		•	•				•	•								•		•	•	•	•	•
PV ICS (Integrated Control Systems)					•	•				•	•	•							•		•		•	•	•
Portable Energy	•	•	•		•	•		•		•	•	•	•						•		•	•	•	•	•
Communication System	•	•	•	•	•	•				•	•	•	•		•	•	•		•	•		•	•	•	•
PDC (Power Distribution Control)	•	•	•	•	•	•				•	•	•							•	•		•	•	•	•
Wind Turbine	•	•	•	•	•	•				•	•	•	•						•		•	•	•	•	•
Energy Storage System	•	•	•	•	•	•				•	•	•							•		•	•	•	•	•
Tidal Power Generation System	•	•	•	•	•	•				•	•	•							•		•	•	•	•	•
Heavy Equipment																									
Electronic Toll System	•	•	•	•	•	•		•		•	•	•	•		•	•			•	•		•	•	•	•
Automotive Diagnostics	•	•	•	•	•	•		•		•	•	•	•	•	•	•			•	•		•	•	•	•
Agriculture Electronic Equipment	•	•	•	•	•	•		•		•	•	•	•		•	•			•	•		•	•	•	•
Lidar & Radar	•	•	•	•	•					•	•	•	•		•	•			•						
ADAS (Advanced Driver Assistance Systems)	•	•	•	•	•	•		•		•	•	•	•		•	•			•	•		•	•	•	•
Telematics & Tracking	•	•	•		•	•		•		•	•	•	•		•	•			•	•	•	•	•	•	•
Camera & Monitoring	•	•	•	•	•	•		•		•	•	•	•		•	•			•	•		•	•	•	•
Control System	•	•	•	•	•	•		•		•	•	•	•		•	•			•	•		•	•	•	•
Display	•	•	•	•	•	•		•		•	•	•	•		•	•			•	•		•	•	•	•
GPS System	•	•	•	•	•	•		•		•	•	•	•		•	•			•	•		•	•	•	•
Lighting	•	•	•		•	•				•	•			•					•		•				
Measurement Systems	•	•	•	•	•	•		•		•	•	•	•		•	•			•	•		•	•	•	•
Sensors		•	•	•	•			•		•	•								•						
Automated Meter Reading																									
Water Meter	•	•	•	•	•			•				•	•						•	•		•	•	•	•
Electricity Meter	•	•	•	•	•			•				•	•						•	•		•	•	•	•
Gas Meter	•	•	•	•	•			•				•	•						•	•		•	•	•	•
Alarm System	•	•	•	•	•			•				•	•						•	•		•	•	•	•
Military Drone	•	•	•	•	•			•											•	•		•	•	•	•
Vehicle Tracking	•	•	•	•	•			•				•	•						•	•		•	•	•	•
Telemetry	•	•	•	•	•			•				•	•						•	•		•	•	•	•
Sewage	•	•	•	•	•	•		•				•	•						•	•		•	•	•	•
Rugged IT																									
Telemetry		•	•	•				•				•	•						•	•		•	•	•	•
Rugged & Military VR and AR		•	•	•				•				•							•	•		•	•	•	•
Rugged Notebook				•								•	•		•	•			•	•					•
Night Vision Goggle			•	•				•				•							•						
Miniature Camera												•							•	•					
Rugged Tablet												•			•	•			•	•					
Communication Devices				•								•	•		•	•			•	•				•	•

Served Markets & Applications

Applications	Ceres	X-Lok	M series	FLOS & FLOS+	Power	RBL	Deep Tronica	HS-Lok	NMEA 2000	7/8" Mini	Heavy Duty Shielded	RJ45	USB	SSL	HDMI	DVI	Fiber Optics	Zconnect	RF	Cable Joiner	Cable Gland	Vent	LED Light Guide	D-Sub
Test Equipments																								
Air Flow Measurement	•	•	•	•	•	•		•		•	•	•	•					•	•			•		
Gas Detectors	•	•	•	•	•	•		•		•	•	•	•					•	•			•		
Precision Surveying	•	•	•	•	•	•		•		•	•	•	•		•	•		•	•			•		•
Earthquake Monitoring	•	•	•	•	•	•		•		•	•	•	•					•	•			•		
Humidity Measurement	•	•	•	•	•	•		•		•	•	•	•					•	•			•		
Leak Detectors	•	•	•	•	•	•		•		•	•	•	•					•	•			•		
Light Measuring	•	•	•	•	•	•		•		•	•	•	•					•	•			•		
Sound Measuring	•	•	•	•	•	•		•		•	•	•	•					•	•			•		
Water Measurement	•	•	•	•	•	•		•		•	•	•	•					•	•			•		
Weighing Devices	•	•	•	•	•	•		•		•	•	•	•					•	•			•		
Weigh Modules	•	•	•	•	•	•		•		•	•	•	•					•	•			•		
Heavy-duty Scales	•	•	•	•	•	•		•		•	•	•	•		•	•		•	•			•		•
Floor Scales	•	•	•	•	•	•		•		•	•	•	•		•	•		•	•			•		•
Wet Area Weighing	•	•	•	•	•	•		•		•	•	•	•					•	•			•		
Dosing Systems	•	•	•	•	•	•		•		•	•	•	•					•	•			•		
In-Motion Weighing	•	•	•	•	•	•		•		•	•	•	•					•	•			•		
Borescope	•	•	•	•	•	•		•		•	•	•	•					•	•			•		
Image Measurement	•	•	•	•	•	•		•		•	•	•	•					•	•			•		
Timers / Timer Display	•	•	•	•	•	•		•		•	•	•	•					•	•			•		
Laser Marking System	•	•	•	•	•	•		•		•	•	•	•					•	•			•		
Digital Microscopes	•	•	•	•	•	•		•		•	•	•	•					•	•			•		
Hybrid Electric Vehicles																								
Electric Wheelchair	•	•	•	•	•	•		•		•	•	•	•					•	•			•		
Electrical and Electronic Speed Control	•	•	•	•	•	•		•		•	•	•	•					•	•			•		
Electrical and Electronic Brake System	•	•	•	•	•	•		•		•	•	•	•					•	•			•		
Throttle Controller	•	•	•	•	•	•		•		•	•	•	•					•	•			•		
Battery Module	•	•	•	•	•	•		•		•	•	•	•					•	•			•		
Motor Module	•	•	•	•	•	•		•		•	•	•	•					•	•			•		
Gear Shift Module	•	•	•	•	•	•		•		•	•	•	•					•	•			•		
Controller Unit	•	•	•	•	•	•		•		•	•	•	•					•	•			•		
Charge Plug / Inlet	•	•	•	•	•	•		•		•	•	•	•					•	•			•		
Charging Station	•	•	•	•	•	•		•		•	•	•	•					•	•			•		
Home Charge Platform	•	•	•	•	•	•		•		•	•	•	•					•	•			•		
Hoverboard	•	•	•	•	•	•		•		•	•	•	•					•	•			•		
Electric Scooter	•	•	•	•	•	•		•		•	•	•	•					•	•			•		
Railway Mass Transit																								
Infotainment Systems	•	•	•	•	•	•		•		•	•	•	•		•	•		•	•			•	•	•
In-Vehicle Information System	•	•	•	•	•	•		•		•	•	•	•		•	•		•	•			•	•	•
Indication Display	•	•	•	•	•	•		•		•	•	•	•		•	•		•	•			•	•	•
Navigation/GPS	•	•	•	•	•	•		•		•	•	•	•		•	•		•	•			•	•	•
HVAC (Heating Ventilation Air Conditioning)	•	•	•	•	•	•		•		•	•	•	•					•	•			•	•	•
Fuel Leakage Detector	•	•	•	•	•	•		•		•	•	•	•					•	•			•	•	•
Broadcasting System	•	•	•	•	•	•		•		•	•	•	•					•	•			•	•	•
Vehicle Monitoring	•	•	•	•	•	•		•		•	•	•	•		•	•		•	•			•	•	•
Cleaning Control	•	•	•	•	•	•		•		•	•	•	•					•	•			•	•	•
Speedometer	•	•	•	•	•	•		•		•	•	•	•					•	•			•	•	•
Interior Lighting	•	•	•	•	•	•		•		•	•	•	•					•	•			•	•	•
Mobile Devices																								
DRC (Drone Remote Controller)	•	•	•	•	•	•		•		•	•	•	•					•	•			•	•	•
Altimeter	•	•	•	•	•	•		•		•	•	•	•					•	•			•	•	•
Barcode Reader	•	•	•	•	•	•		•		•	•	•	•					•	•			•	•	•
GPS Safety Guard	•	•	•	•	•	•		•		•	•	•	•					•	•			•	•	•
Portable Lamp	•	•	•	•	•	•		•		•	•	•	•					•	•			•	•	•
Gesture Measurement	•	•	•	•	•	•		•		•	•	•	•					•	•			•	•	•
Wearables	•	•	•	•	•	•		•		•	•	•	•					•	•			•	•	•

Served Markets & Applications

Applications	Ceres	X-Lok	M series	FLOS & FLOS+	Power	RBL	Deep Tronica	HS-Lok	NMEA 2000	7/8" Mini	Heavy Duty Shielded	RJ45	USB	SSL	HDMI	DVI	Fiber Optics	Zconnect	RF	Cable Joiner	Cable Gland	Vent	LED Light Guide	D-Sub	
Transportation																									
Vehicle Camera	•	•	•	•		•		•					•		•			•			•	•			
Switch			•									•	•					•							•
Dome Vehicle Camera	•	•	•			•												•				•	•		
RFID Reader																		•	•						
Bus GPS	•	•	•	•		•		•				•	•		•	•		•	•						
Displayer	•	•	•	•		•												•							
Outdoor Speaker	•	•	•	•		•												•							
Automotive Winches																		•							
Vehicle Charger	•	•	•			•												•							
Wifi Router												•						•							
Fleet Management	•	•	•	•		•												•							
Digital Video Surveillance System	•	•	•	•	•	•				•	•	•						•						•	
Medical Equipment																									
Medical Displays				•	•							•	•		•	•		•				•			•
Mobile Nursing Carts	•	•			•	•		•		•	•				•	•		•				•	•		
Non-invasive Devices	•	•		•	•	•		•		•	•	•	•		•	•		•				•	•		•
Electrical Beds	•	•	•		•	•				•	•							•				•	•		
Charges	•	•			•	•				•	•							•				•	•		
Wheelchair Lift	•	•			•	•				•	•							•				•	•		
Wheelchair Stair Lift	•	•			•	•				•	•							•				•	•		
Rehabilitation System	•	•			•	•				•	•							•				•	•		
Automotive Diagnostics																									
Auto Crash Notification	•	•	•	•	•	•		•		•	•	•	•					•	•						•
Vehicle Tracking	•	•	•		•	•		•		•	•		•					•	•				•		
Vehicle Health Alert & Roadside Assistance	•	•	•	•	•	•		•		•	•	•	•					•	•						•
Remote Vehicle Diagnostics	•	•	•	•	•	•		•		•	•	•	•	•	•	•		•	•				•	•	•
UAV																									
Commercial Drone	•	•	•	•	•	•		•		•	•	•	•		•	•		•	•			•	•	•	•
Military Drone	•	•	•	•	•	•		•		•	•	•	•		•	•		•	•			•	•	•	•
Consumer Drone	•	•	•	•	•	•		•		•	•	•	•		•	•		•	•			•	•	•	•
Lifts & Materials Handling																									
Forklift	•	•	•	•	•	•		•		•	•	•	•		•	•		•				•	•	•	•
Industrial Lift	•	•	•	•	•	•		•		•	•	•	•		•	•		•				•	•	•	•
Materials Handling	•	•	•	•	•	•		•		•	•	•	•		•	•		•				•	•	•	•
Remote Video Response Center																									
Encoders	•	•	•	•	•			•		•	•	•	•		•	•		•	•			•	•		•
Monitoring Station	•	•	•		•	•				•	•	•	•		•	•		•				•			•
CCTV/Dome/IP Camera	•	•	•	•	•			•		•	•	•	•		•	•		•	•	•		•	•		•
Remote Control	•	•			•			•				•	•					•				•			•
Junction Box	•	•			•							•	•		•	•		•				•	•		•
Automatic LPRS (License Plate Recognition System)	•	•	•	•	•			•		•	•	•	•		•	•		•	•	•		•	•		•
Fingerprint ID												•						•							
Alarm System	•	•	•	•	•			•				•	•		•	•		•	•	•		•	•		•
Sensor			•															•							
Autonomous																									
GPS	•	•	•	•				•		•	•	•	•		•	•		•	•						
Lidar	•	•	•	•				•		•	•	•	•		•	•		•				•	•		
Radar Sensors	•	•	•	•				•		•	•							•	•						
Video Cameras	•	•	•	•				•		•	•		•		•	•		•				•	•		
Central Computer	•	•	•	•				•		•	•	•	•		•	•		•							
Inertial Measurement Unit	•	•	•	•				•		•	•							•							
Inertial Navigation Systems	•	•	•	•				•		•	•							•	•						
Commercial Military																									
Commercial Military				•														•							

WE ARE AMPHENOL LTW

Founded in 1993, Amphenol LTW is a leader in rugged and harsh environment interconnects with the largest array of I/O and products ranging from IP65 to IP69K. The company continually provides innovative interconnect solutions for ever-demanding environments and is proactively committed to contributing to a safer and greener environment. Amphenol LTW features interconnects for technologically advanced products with environmentally friendly results.



AMPHENOL LTW TECHNOLOGY & CNC PLANT

- Headquarters: Taipei, Taiwan
- 150 Employees



KUNSHAN AMPHENOL ZHENGRI ELECTRONICS

- Kunshan, China
- 400 Employees



110+

Amphenol
Division



75+

Distribution
Channel



30+

Market
Applications

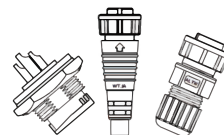

80,000+

Products

Visit our website for
detailed information

Scan here



OUR CAPABILITIES

Both factories located in Taiwan and China are ISO9001:2015, ISO14001:2015, and UL certified. Our Test Laboratory is certified by TAF and is member of UL WTDP reliable partner. Wherever required, most of our products are TUV/VDE, UL/CSA certified. Thanks to our strict standards, we are able to contribute to your projects and design exactly what you need. From standard to customized products, Amphenol LTW has the right solutions for your applications.



Test Laboratory Accreditation

Quality Assurance

International Certifications



Automated Production Line

Capability: Contacts, Parts, and Shells

Number of Automatic Machines: 11

Production Capacity : 125,000 pins per day
(24 hours)

Number of CNC Machines: 33

Production Capacity : 125,000 pins per day
(24 hours)



Kunshan Factory – Horizontal Injection Workshop

Molding Machines

Number of Machines: 17

Production Capacity : 3400pcs/hr

ONLINE RESOURCES

Coming Soon

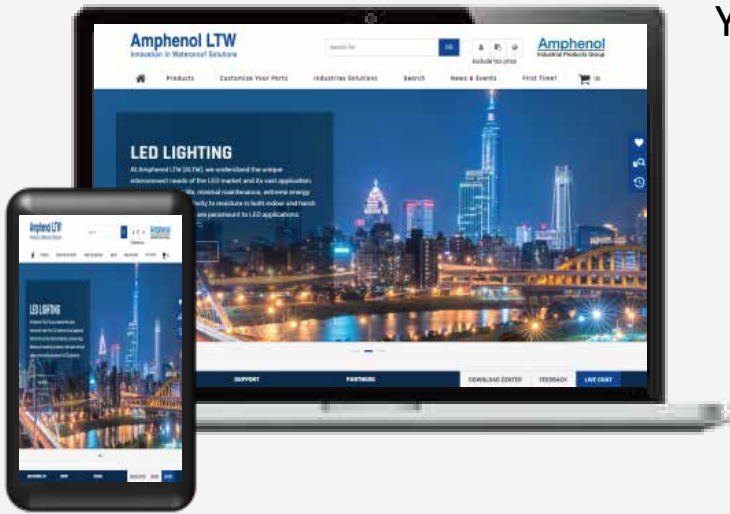

www.amphenolltw.com

YOUR SOLUTION ONLY ONE CLICK AWAY

Our E-SHOP

Visit our website to find all our products, prices and technical data. Online ordering is easier now!



Scan our QR Code

Visit the online shop



OUR CATALOG

Product catalogs are available on our website.

Download for more details:
www.amphenolltw.com



Scan for more details



General Catalog
Find All Product Range



Catalogs by Series
All Market Applications



Market Flyer
Product guidance

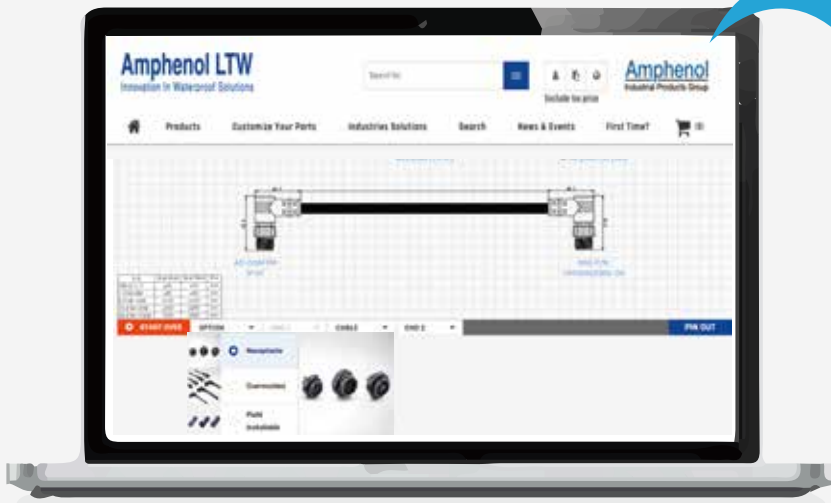

FAST
EFFICIENT

Configure To Order (CTO)

Configure your own connector/cable assembly directly on our website by choosing the components and parts that you need.

www.customcable.com

Benefits

- ✓ Worldwide Access 24/7
- ✓ Easy & Quick Customization
- ✓ Real Time Order Tracking
- ✓ Online Assistance (Live Chat)
- ✓ Instant Drawing Release
- ✓ Instant quotation
- ✓ Order Online

Scan the QR Code to our CTO platform

Scan here



Just A Few Simple Steps

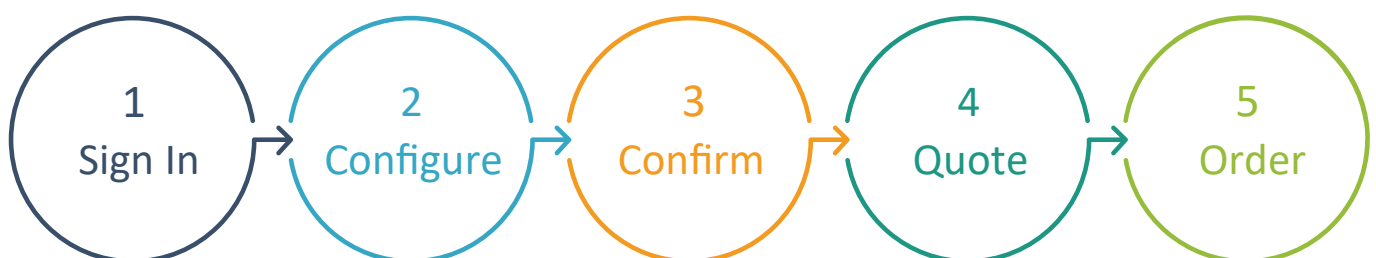



VISUALIZE OUR PRODUCTS

Augmented Reality (AR) is an interactive and unique technology that combines the virtual and real world.

Amphenol LTW incorporates AR features to your design work for an easy, seamless, fast and unforgettable experience.

Try the AR experience now!

4 Easy Steps



Scan the QR Code and connect to the ALTW AR app
*Available 2022 Q1



iOS



Android

* For smartphones and tablets

TECHNICAL SUPPORT



ASSISTANCE



AIPG WeChat (ID: AIPG2020)
安费诺工业展品集团
微信公众号: AIPG2020



88677416888

INFORMATION



FAQ

Find answers to frequently asked questions at
<https://www.amphenoltw.com/>



Feedback

Any comments about the catalog?
Help us improve the catalog user experience by sharing your suggestions.
Email us at
sales@ltw-tech.com

Follow us on





Commercial Military



Medical Equipment



Battery Management System



Automotive



Industrial Automation



Mobile Devices



Drone



GPS



Advanced Driver Assistance Systems



Power Distribution Control



Battery Module



Energy Storage System

Automotive



Lighting

- DRL (Daytime running light)
- Turn signal indicator, parking lights
- Signature lighting, rear lights



Steering Column Switch

- Wiper
- Turn signal
- Cruise control



Camera Module

- Parking sensor
- Around view monitoring
- Data video recorder



Power Train

- Transmission control unit

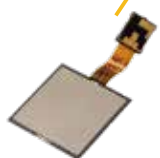

Sensor

- Pressure sensors
- Keyless entry sensor
- Electronic door handle



Infotainment System

- Touch screen display
- Audio/video interface
- Navigation



Battery Management System

- Battery FPC/PCB module

Product Range Overview

Sub-Series Name	ZConnect
Mating Style	Quick plug
Plastic Version	✓
Metal Version	✓
No. of Contacts	40 / 36 / 20 / 18 / 12
Housing Material	LCP
Contact Material	PBT + PC
Plating of Contacts	Gold Plated
Rated Voltage (AC/DC)	120V
Nominal Current	1A
Operating Temperature	-40°C ~ 110°C
Mating Cycles (Pin Contact)	10 Cycles
IP Rating	N/A
Salt Spray (Connector, Mated)	48h
UV Resistant	f1
Flammability Rating	UL94V-0
RoHS 2.0 Compliant	✓
REACH Compliant	✓
Certificates	LV214

Contact Configuration

Pin	0.9 Pitch	Pin	1.8 Pitch	Pin	2.7 Pitch
22	○	11	○	8	○
24	○	12	○	10	○
26	○	13	○	12	●
28	○	14	○		
30	○	15	○		
32	○	16	○		
34	○	17	○		
36	●	18	●		
38	○	19	○		
40	●	20	●		

● Available
○ Upon Request

Assembly Instruction

FPC insert into PLUG with orientation error proof design and with auto locking function

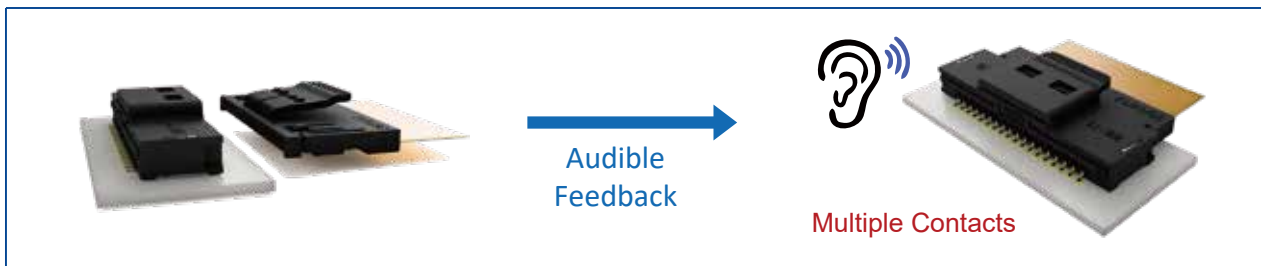
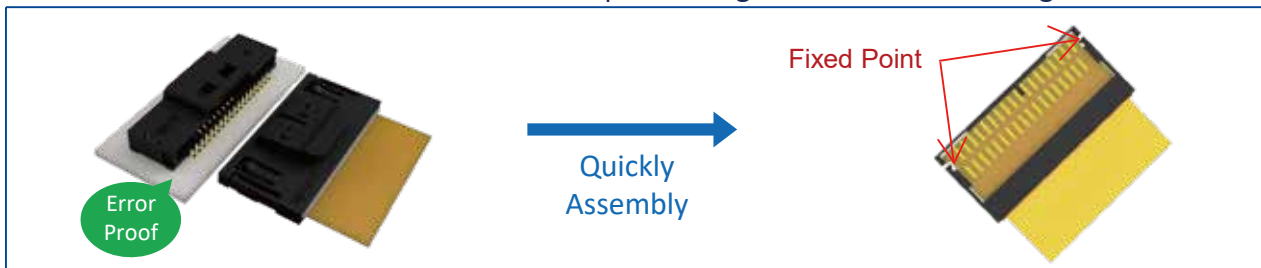

Ordering Information

Example

Z A - 11 B F R S - B A 0 - 001
 XX X - XX X X X X - X X X - XXX

1 2 3 4 5 6 7 8 9 10 11

Specification

(Z) Non Shielded
 (ZS) Shielded

Code

(A) A Code
 (B) B Code
 (C) C Code

Number Of Contacts

Female	Male
08, ... ,40 Pin	(AA) 40(P0.9) / 20(P1.8)
	(AB) 38(P0.9) / 19(P1.8)
	(AC) 36(P0.9) / 18(P1.8) / 12(P2.7)
	(AD) 34(P0.9) / 17(P1.8)
	(AE) 32(P0.9) / 16(P1.8)
	(AF) 30(P0.9) / 15(P1.8) / 10(P2.7)
	(AG) 28(P0.9) / 14(P1.8)
	(AH) 26(P0.9) / 13(P1.8)
	(AI) 24(P0.9) / 12(P1.8) / 8(P2.7)
	(AJ) 22(P0.9) / 11(P1.8)

Pin Pitch

Female	Male
(A) 0.9	(N) None
(B) 1.8	
(C) 2.7	

Contact Gender

(M) Male Contact
 (F) Female Contact

Connector Style

Female	Male
(R) Right Angle	(A) Assembly
(V) Vertical	

Terminal Style

Female	Male
(S) SMD	(N) None
(T) THT	

Color

(B) Black
 (G) Gary

Plating

Female	Male
(A) AU	(N) None
(T) Tin	

Waterproof Rating

(0) None	(7) IPX7
(5) IPX5	(8) IPX8
(6) IPX6	

More Information

Female	Male	Male With Wires
(001), (002).....	(001)	(□) + (■) Type + Cable Length
For Different Versions	(Only Connector)	e.g. (B15) = FFC + 150mm
		(□): (A) FFC (■) Cable Length
		(B) FFC (10) 100mm ~ (95) 950mm * Every 50mm As Per Extension
		(C) Wire-To-Board (A0) 1000mm ~ (A5) 1500mm * Every 100mm As Per Extension

> SMT Socket

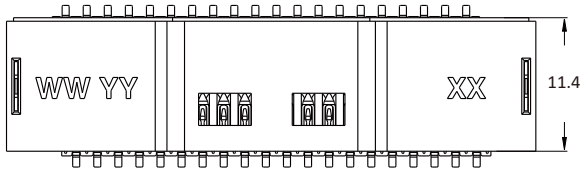
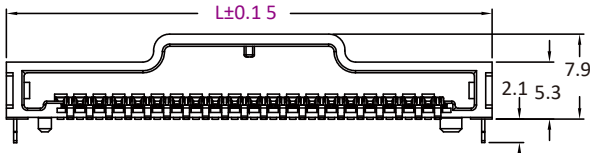

Pin (n)	Pitch	L	E	H	I	F	G	D
8	2.7	30.8	16.2	7.65	8.55	10.35	5.85	29.13
10		36.2	21.6	13.05	8.55	10.35	11.25	32.75
12		41.6	27.0	13.05	13.95	15.75	11.25	39.95

Pin(n)	Pitch	L	A	B	C	D
11	1.8	29.0	18.0	9.45	8.55	27.35
12		30.8	19.8	9.45	10.35	29.15
13		32.6	21.6	11.25	10.35	30.95
14		34.4	23.4	11.25	12.15	32.75
15		36.2	25.2	13.05	12.15	34.55
16		38.0	27.0	13.05	13.95	36.35
17		39.8	28.8	14.85	13.95	38.15
18		41.6	30.6	14.85	15.75	39.95
19		43.4	32.4	16.65	15.75	41.75
20		45.2	34.2	16.65	17.55	43.55
22	0.9	29.0	18.0	9.45	8.55	27.35
24		30.8	19.8	9.45	10.35	29.15
26		32.6	21.6	11.25	10.35	30.95
28		34.4	23.4	11.25	12.15	32.75
30		36.2	25.2	13.05	12.15	34.55
32		38.0	27.0	13.05	13.95	36.35
34		39.8	28.8	14.85	13.95	38.15
36		41.6	30.6	14.85	15.75	39.95
38		43.4	32.4	16.65	15.75	41.75
40		45.2	34.2	16.65	17.55	43.55

0.9mm Pitch

• Part Number: ZA-3 AFRS-BA0001

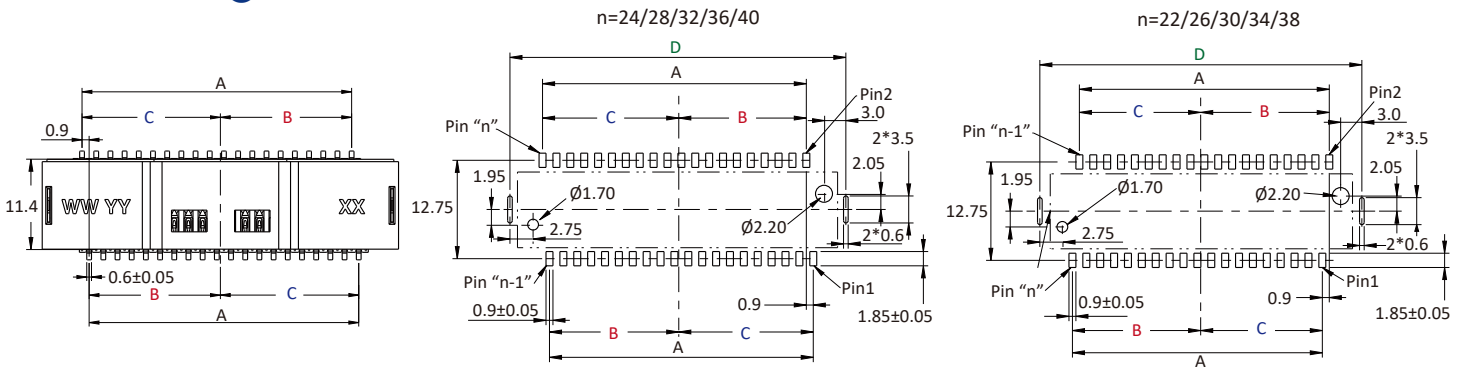

1.8mm Pitch

• Part Number: ZA-3 BFRS-BA0001

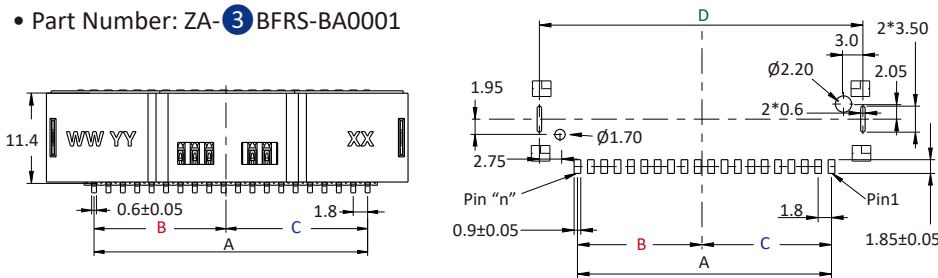

2.7mm Pitch

• Part Number: ZA-3 CFRS-BA0001

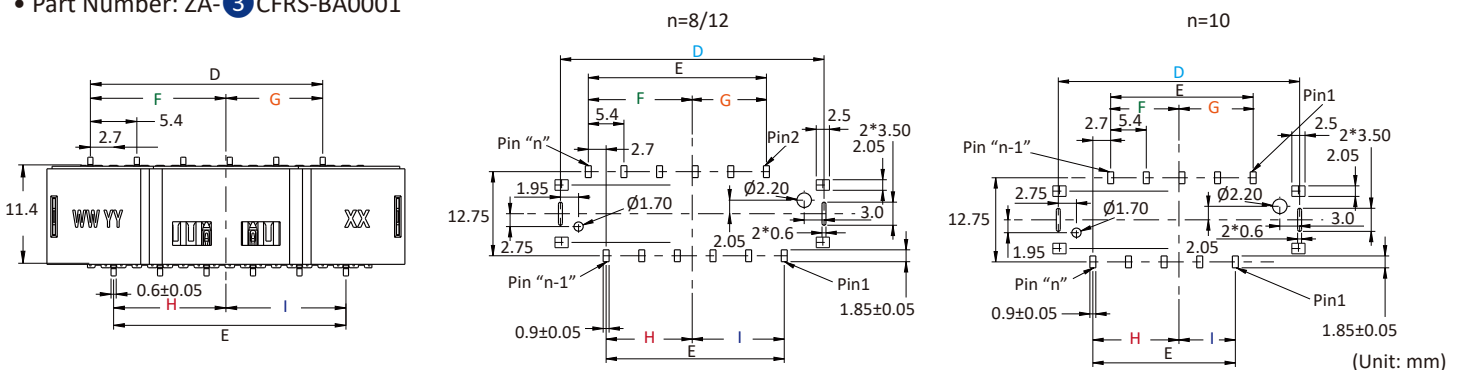

> Plug

• Part Number: ZA-3 NMAN-BN0001

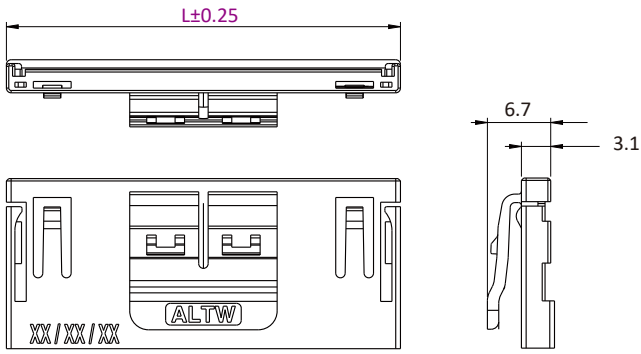

3 Pin (n)	Pitch	L	A	B	C	D
11	1.8	25.5	18.0	9.45	8.55	23.5
12		27.3	19.8	9.45	10.35	25.3
13		29.1	21.6	11.25	10.35	27.1
14		30.9	23.4	11.25	12.15	28.9
15		32.7	25.2	13.05	12.15	30.7
16		34.5	27.0	13.05	13.95	32.5
17		36.3	28.8	14.85	13.95	34.3
18		38.1	30.6	14.85	15.75	36.1
19		39.9	32.4	16.65	15.75	37.9
20		41.7	34.2	16.65	17.55	39.7
22	0.9	25.5	18.0	9.45	8.55	23.5
24		27.3	19.8	9.45	10.35	25.3
26		29.1	21.6	11.25	10.35	27.1
28		30.9	23.4	11.25	12.15	28.9
30		32.7	25.2	13.05	12.15	30.7
32		34.5	27.0	13.05	13.95	32.5
34		36.3	28.8	14.85	13.95	34.3
36		38.1	30.6	14.85	15.75	36.1
38		39.9	32.4	16.65	15.75	37.9
40		41.7	34.2	16.65	17.55	39.7

3 Pin (n)	Pitch	L	G	H	I	E	D	F
8	2.7	30.8	16.2	16.2	8.55	10.35	5.85	29.13
10		36.2	21.6	13.05	8.55	10.35	11.25	32.75
12		41.6	27.0	13.05	13.95	15.75	11.25	39.95

0.9mm Pitch

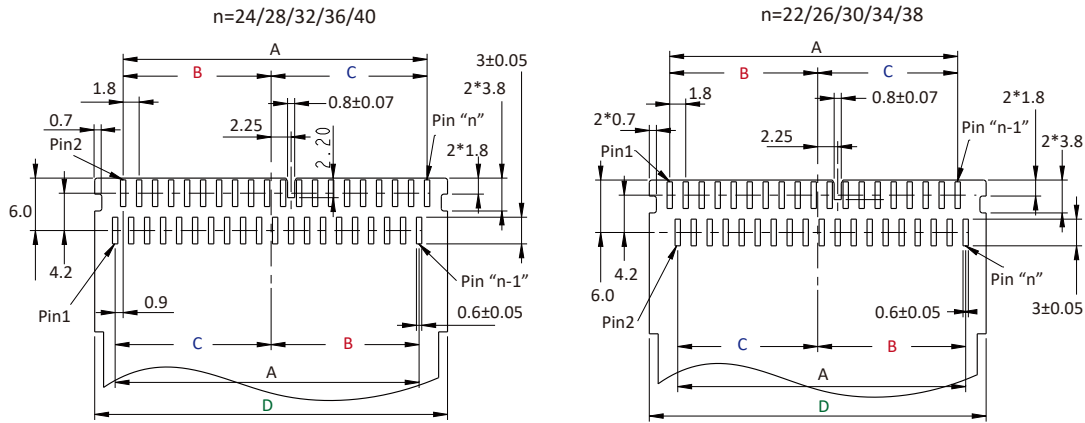

1.8mm Pitch

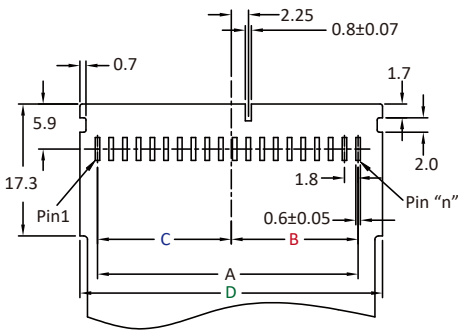

2.7mm Pitch

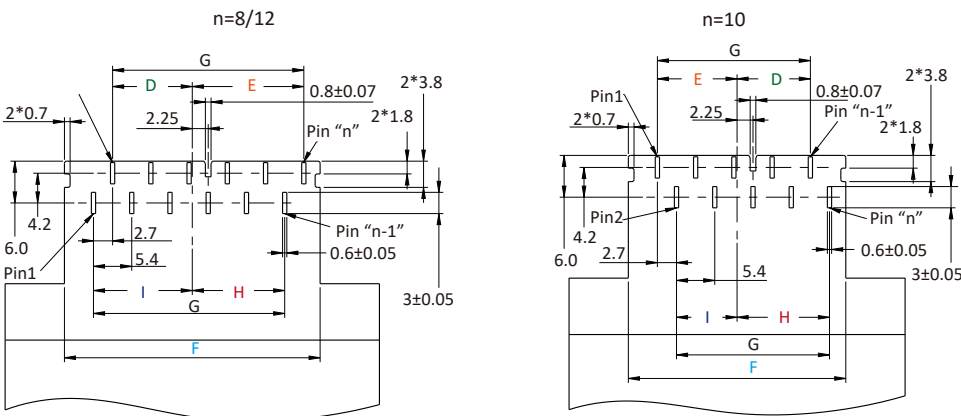

(Unit: mm)

Cable List

Item No.	Jacket	Color	UL No.	Cable Specification	Cable OD	Copper Index (kg/km)	Weight (kg/km)
WCA00011181	PVC	Black	SJTW	12AWG*2C+Filler	10.70	60.80	163.10
WCA00011226	PVC	Black	SJTW	12AWG*3C	11.20	89.60	222.90
WCA00011182	PVC	Black	SJTW	12AWG*3C+Filler	11.70	89.85	207.67
WCA00011243	PVC	Black	UL2464	12AWG*3C+Filler	10.00	90.00	164.40
WCA00011242	PVC	Black	UL2464	12AWG*4C+Filler	11.00	120.40	228.70
WCA00012002	PVC	Black	SJTW	12AWG*4C+Filler	12.30	122.00	293.00
WCA00011183	PVC	Black	SJTW	12AWG*5C+Filler	13.60	149.50	328.90
WCA00010846	PVC	Black	UL1277, UL1581&UL83	14AWG*3C	9.70	53.80	134.20
WCA0485XX01	PVC	Black	UL2464	14AWG*3C+Talcum	7.00	55.80	100.10
WCA00011884	PU	Black	UL20234	14AWG*5C+Filler+Paper	10.00	115.70	180.00
WCA00012012	PU	Black	UL20234	14AWG*5C+Filler+Paper	10.00	115.70	180.00
WCA00011201	PVC	Black	UL21388	16AWG*2C+AL/Mylar	8.20	23.80	60.20
WCA00011206	PVC	Black	SJTW	16AWG*2C+Filler	8.20	24.25	85.10
WCA0264UV01	PVC	Black	UL2464	16AWG*2C+Talcum	5.80	23.80	57.70
WCA00010942	PVC	Black	UL2464	16AWG*2C+Talcum	7.80	24.20	95.00
WCA00010625	PVC	Black	UL2464	16AWG*3C+AL.Mylar+Drain	7.50	46.80	96.60
WCA00011202	PVC	Black	UL21388	16AWG*3C+AL/Mylar	8.60	35.70	71.50
WCA0579UV01	PVC	Black	UL2464	16AWG*3C+Drain+AL.Mylar	7.50	46.70	97.90
WCA00011207	PVC	Black	SJTW	16AWG*3C+Filler	8.60	36.02	105.21
WCA0285UV01	PVC	Black	UL2464	16AWG*4C+AL.Mylar	7.50	47.60	99.90
WCA00011203	PVC	Black	UL21388	16AWG*4C+AL/Mylar	9.30	47.60	88.40
WCA00011208	PVC	Black	SJTW	16AWG*4C+Filler	9.30	49.00	131.50
WCA00011204	PVC	Black	UL21388	16AWG*5C+AL/Mylar	10.70	59.40	99.80
WCA0263UV01	PVC	Black	UL2464	16AWG*5C+Talcum	7.80	59.50	108.80
WCA00011205	PVC	Black	UL21388	16AWG*6C+AL/PET	11.70	71.30	123.30
WCA0582UV01	PVC	Black	UL2464	16AWG*6C+Filler+Drain+AL.Mylar	9.50	82.10	153.60
WCA0583UV01	PVC	Black	UL2464	16AWG*7C+Drain+AL.Mylar	9.50	93.60	175.70
WCA00011299	PVC	Black	UL2464	18AWG*10C	9.00	77.00	145.00
WCE00010070-43	PVC	Black	UL21996	18AWG*2C+Talcum	3.4*5.3	14.82	36.97
WCE00010074-43	PVC	White	UL21996	18AWG*2C+Talcum	3.4*5.3	14.82	36.97
WCA00010897	PVC	Black	UL1277, UL15, 81&UL83	18AWG*3C	8.50	21.30	81.93
WCA00011209	PVC	Black	SJTW	18AWG*3C+Filler	8.00	21.30	81.93
WCA00010898	PVC	Black	UL1277, UL15, 81&UL83	18AWG*4C	9.20	35.00	125.00
WCE00010071-43	PVC	Black	UL21996	18AWG*4C+Talcum	3.4*9.2	29.64	68.14
WCE00010075-43	PVC	White	UL21996	18AWG*4C+Talcum	3.4*9.2	29.64	68.14
WCA00011240	PVC	Black	UL2464	20AWG*10C+AL.Mylar+Filler	9.00	48.00	116.40
WCA00011192	PVC	Black	UL21388	20AWG*10C+AL/Mylar	8.50	48.00	109.70
WCA00011436	PVC	Black	UL2464	20AWG*12C+AL.Mylar+Filler	9.00	57.60	125.10
WCA00011193	PVC	Black	UL21388	20AWG*12C+AL/Mylar	8.50	57.60	121.70
WCA00011200	PVC	Black	UL21388	20AWG*14C+AL/Mylar	8.50	67.20	130.60
WCA0470XX01	PVC	Black	UL2464	20AWG*14C+Braid	9.50	87.90	161.30
WCA0153XX01	PVC	Black	UL2464	20AWG*18C+AL.Mylar	9.50	86.40	154.20
WCA00011581-43	PVC	Black	UL 21996	20AWG*2C	5.20	9.40	34.02
WCA00011194	PVC	Black	UL21388	20AWG*18C+AL/Mylar	10.00	86.40	174.70
WCA00010781	PVC	Black	UL2464	20AWG*2C+AL.Mylar+Braid	5.50	17.70	41.60
WCA00011184	PVC	Black	UL21388	20AWG*2C+AL/Mylar	5.50	9.60	27.40
WCA0124UV01	PVC	Black	UL2464	20AWG*2C+Drain+AL.Mylar	5.80	14.40	48.40
WCE00010072-43	PVC	Black	UL21996	20AWG*2C+Talcum	3.2*5.0	14.10	41.45
WCE00010076-43	PVC	White	UL21996	20AWG*2C+Talcum	3.2*5.0	14.10	41.45
WCA00011580-43	PVC	Black	UL 21996	20AWG*3C	5.50	14.10	41.45
WCA0489UV01	PVC	Black	UL2464	20AWG*3C+AL.Mylar	5.00	14.40	39.30
WCA00010602	PVC	Black	UL2464	20AWG*3C+AL.Mylar+Braid+Drain	5.50	29.20	61.90
WCA00011185	PVC	Black	UL21388	20AWG*3C+AL/Mylar	5.50	14.40	43.70
WCA00011548-43	PVC	Black	UL 21996	20AWG*4C	6.00	18.80	48.46
WCA00011186	PVC	Black	UL21388	20AWG*4C+AL/Mylar	6.00	19.20	51.40
WCA0575UV01	PVC	Black	UL2464	20AWG*4C+Drain+AL.Mylar	5.50	24.00	52.10
WCE00010073-43	PVC	Black	UL21996	20AWG*4C+Talcum	3.2*8.5	18.80	53.34
WCE00010077-43	PVC	White	UL21996	20AWG*4C+Talcum	3.2*8.5	18.80	53.34
WCA00011187	PVC	Black	UL21388	20AWG*5C+AL/Mylar	6.20	24.00	59.20
WCA0576UV01	PVC	Black	UL2464	20AWG*5C+Drain+AL.Mylar	6.00	28.80	62.70
WCA00011188	PVC	Black	UL21388	20AWG*6C+AL/Mylar	6.80	28.80	71.80
WCA0577UV01	PVC	Black	UL2464	20AWG*6C+Drain+AL.Mylar	6.50	33.60	76.80
WCA00011189	PVC	Black	UL21388	20AWG*7C+AL/Mylar	6.80	33.60	75.80
WCA00010049	PVC	Black	UL2464	20AWG*7C+Drain+AL.Mylar	6.50	38.40	74.80
WCA00010550	PVC	Black	UL2464	20AWG*8C+AL.Mylar+Drain+Filler	6.80	43.00	86.00

Cable List

Item No.	Jacket	Color	UL No.	Cable Specification	Cable OD	Copper Index (kg/km)	Weight (kg/km)
WCA00011190	PVC	Black	UL21388	20AWG*8C+AL/Mylar	7.20	38.40	87.00
WCA00011489-28	PVC	Black	UL2464	20AWG*9C+AL.Mylar+Drain	7.40	48.50	101.80
WCA00011191	PVC	Black	UL21388	20AWG*9C+AL/Mylar	7.60	43.20	97.30
WCA00010868	PVC	Black	UL2464	22AWG*2C+Talcum	4.20	6.20	24.60
WCA00011339	PVC	Yellow	UL2517	22AWG*3C	4.50	9.00	31.50
WCA00011343	PU	Black	UL20549	22AWG*3C	3.80	9.00	26.00
WCA00011459-28	PVC	Black	UL2517	22AWG*3C	4.50	9.30	31.00
WCA00010063	PU	Black	NONUL	22AWG*3C+Talcum	4.50	9.00	26.40
WCA0570UV01	PVC	Black	UL2464	22AWG*3C+Talcum	5.00	9.30	35.20
WCA00011340	PVC	Yellow	UL2517	22AWG*4C	4.80	11.70	40.00
WCA00011344	PU	Black	UL20549	22AWG*4C	4.00	12.00	31.80
WCA00011460-28	PVC	Black	UL2517	22AWG*4C	4.80	12.00	38.00
WCA00011813-01	PVC	Black	UL2517	22AWG*4C+AL.Mylar+Braid	5.30	22.00	46.00
WCA00011872	PU	Black	UL20549	22AWG*4C+AL.Mylar+Braid+Paper	5.30	22.00	48.00
WCA00010062	PU	Black	NONUL	22AWG*4C+Insulation	4.80	12.00	29.40
WCA0571UV01	PVC	Black	UL2464	22AWG*4C+Talcum	5.00	12.40	38.60
WCA00011341	PVC	Yellow	UL2517	22AWG*5C	5.10	15.50	43.80
WCA00011687-01	PVC	Black	UL2517	22AWG*5C+AL.Mylar+Filler+Braid	5.70	26.00	58.00
WCA00011345	PU	Black	UL20549	22AWG*5C+Filler	4.40	15.00	43.50
WCA00011461-28	PVC	Black	UL2517	22AWG*5C+Filler	5.10	15.00	43.00
WCA00011870	PU	Black	UL20549	22AWG*5C+Filler+AL.Mylar+Braid+Paper	5.70	26.00	51.00
WCA00012245	PU	Black	UL20549	22AWG*5C+Filler+Paper	5.60	19.00	51.00
WCA00010061	PU	Black	NONUL	22AWG*5C+Filler+Talcum+Paper	5.00	15.50	38.50
WCA0352XX02	PU	Black	NONUL	22AWG*5C+Talcum	5.00	15.50	47.50
WCA0521UV01	PVC	Black	UL2464	22AWG*5C+Talcum	5.50	15.50	47.50
WCA0556UV01	PVC	Black	UL2464	24AWG*10C+Drain+AL.Mylar	6.50	22.00	63.80
WCA0557UV01	PVC	Black	UL2464	24AWG*12C+Drain+AL.Mylar	7.00	26.00	72.30
WCA0558UV01	PVC	Black	UL2464	24AWG*14C+Drain+AL.Mylar	7.00	30.00	77.10
WCA0465UV01	PVC	Black	UL2464	24AWG*15C+Drain+AL.Mylar	7.00	32.00	77.60
WCA0560UV01	PVC	Black	UL2464	24AWG*18C+Drain+AL.Mylar	8.00	38.00	100.70
WCA0284UV01	PVC	Black	UL2464	24AWG*25C+Drain+AL.Mylar	9.00	51.90	130.90
WCA0072UV01	PVC	Black	UL2464	24AWG*2C+Drain+AL.Mylar	4.20	6.00	24.00
WCA0027UV01	PVC	Black	UL2464	24AWG*2C+Talcum	4.20	4.00	22.70
WCA00010114	PVC	Black	UL2464	24AWG*37C+Drain+AL/Mylar	9.50	74.00	153.20
WCA00011746-03	PVC	Black	UL2517	24AWG*3C+AL.Mylar+Braid	4.60	13.10	31.30
WCA0549UV01	PVC	Black	UL2464	24AWG*3C+Drain+AL.Mylar	4.50	8.00	29.00
WCA0006UV01	PVC	Black	UL2464	24AWG*3C+Talcum	4.50	6.00	27.70
WCA00011726-03	PVC	Black	UL2517	24AWG*4C+AL.Mylar+Braid	5.00	16.40	38.50
WCA0219UV01	PVC	Black	UL2464	24AWG*4C+Drain+AL.Mylar	5.80	10.00	45.60
WCA0036UV01	PVC	Black	UL2464	24AWG*4C+Talcum	5.00	8.00	32.40
WCA00011584-43	PVC	Black	UL 21996	24AWG*5C	5.50	9.88	41.20
WCA0551UV01	PVC	Black	UL2464	24AWG*5C+Drain+AL.Mylar	5.00	12.00	37.00
WCA0229UV01	PVC	Black	UL2464	24AWG*5C+Talcum	5.00	10.00	34.40
WCA00011583-43	PVC	Black	UL 21996	24AWG*6C	5.80	11.86	45.21
WCA00011214	PVC	Black	UL2464	24AWG*6C+AL.Mylar	5.00	12.00	39.40
WCA0217UV01	PVC	Black	UL2464	24AWG*6C+Drain+AL.Mylar	5.80	14.00	45.00
WCA00011479-28	PVC	Black	UL2517	24AWG*6C+Filler	5.00	12.00	40.00
WCA00012067	PVC	Black	UL21388	24AWG*6C+Filler+AL.Mylar	5.20	11.40	35.40
WCA00011421	PVC	Yellow	UL2517	24AWG*6C+Filler+Talcum	5.00	17.60	49.20
WCA00011422	PU	Black	UL20549	24AWG*6C+Filler+Talcum	5.00	13.00	34.00
WCA0087UV01	PVC	Black	UL2464	24AWG*7C+Drain+AL/Mylar	5.80	16.00	51.00
WCA00011342	PVC	Yellow	UL2517	24AWG*8C	5.50	15.50	48.00
WCA00011346	PU	Black	UL20549	24AWG*8C	4.80	15.50	35.00
WCA00011462-28	PVC	Black	UL2517	24AWG*8C	5.50	15.50	48.00
WCA00011698-01	PVC	Black	UL2517	24AWG*8C+AL.Mylar+Filler+Braid	5.80	27.00	60.00
WCA0003UV01	PVC	Black	UL2464	24AWG*8C+Drain+AL/Mylar	5.50	18.00	45.70
WCA00012066	PVC	Black	UL21388	24AWG*8C+Filler+AL.Mylar	5.60	15.20	43.40
WCA00011814-01	PU	Black	UL20549	24AWG*8C+Filler+AL.Mylar+Braid+Paper	5.80	26.00	51.00
WCA00012341	PU	Black	UL20549	24AWG*8C+Filler+Paper	6.70	19.00	65.00
WCA0203UV01	PVC	Black	UL2464	24AWG*8C+Talcum	5.50	16.00	45.30
WCA0528UV01	PVC	Black	UL2464	24AWG*9C+Drain+AL.Mylar	6.00	20.00	54.80
WCA0540UV01	PVC	Black	UL2464	26AWG*6C+Drain+AL.Mylar	5.00	9.80	33.70
WCA0543UV01	PVC	Black	UL2464	26AWG*10C+Drain+AL.Mylar	6.00	15.00	50.30
WCA00011400	PU	Black	UL20549	26AWG*10C+Filler	6.00	14.00	48.00
WCA00011401	PVC	Yellow	UL2517	26AWG*10C+Filler	6.00	14.00	52.00

Cable List

Item No.	Jacket	Color	UL No.	Cable Specification	Cable OD	Copper Index (kg/km)	Weight (kg/km)
WCA00011463-01	PVC	Black	UL2517	26AWG*10C+Filler	6.00	14.00	52.00
WCA00011380	PU	Black	UL20549	26AWG*12C	6.00	16.00	47.00
WCA00011402	PVC	Yellow	UL2517	26AWG*12C	6.00	17.00	54.00
WCA00011464-01	PVC	Black	UL2517	26AWG*12C	6.00	17.00	55.00
WCA00011782-01	PVC	Black	UL2517	26AWG*12C+AL.Mylar+Braid	6.40	25.00	63.00
WCA00011871	PU	Black	UL20549	26AWG*12C+AL.Mylar+Braid+Paper	6.40	28.00	60.00
WCA0544UV01	PVC	Black	UL2464	26AWG*12C+Drain+AL.Mylar	6.00	17.60	53.10
WCA0545UV01	PVC	Black	UL2464	26AWG*15C+Drain+AL.Mylar	6.50	21.50	58.70
WCA00012148	PU	Black	UL20549	26AWG*17C+Filler	7.00	23.00	63.00
WCA00012173	PVC	Yellow	UL2517	26AWG*17C+Filler	7.00	24.00	73.00
WCA00012149	PVC	Black	UL2517	26AWG*17C+Filler	7.00	24.00	68.00
WCA00012151	PVC	Black	UL2517	26AWG*17C+Filler+AL.Mylar+Braid	7.50	40.00	91.00
WCA00012150	PU	Black	UL20549	26AWG*17C+Filler+AL.Mylar+Braid+Paper	7.50	39.00	80.00
WCA00010045	PVC	Black	UL2464	26AWG*22C+Drain+AL.Mylar	7.50	29.90	78.10
WCA0546UV01	PVC	Black	UL2464	26AWG*26C+Drain+AL.Mylar	8.00	35.80	91.30
WCA0449UV01	PVC	Black	UL2464	26AWG*31C+Drain+AL.Mylar	9.00	42.30	117.40
WCA0481UV01	PVC	Black	UL2464	26AWG*3C+Drain+AL.Mylar	4.00	5.20	22.40
WCA0547UV01	PVC	Black	UL2464	26AWG*44C+Drain+AL.Mylar	10.50	59.20	157.10
WCA0487UV01	PVC	Black	UL2464	26AWG*4C+Drain+AL.Mylar	4.80	7.20	30.80
WCA0486UV01	PVC	Black	UL2464	26AWG*5C+Drain+AL.Mylar	4.80	8.50	33.00
WCA00011480-01	PU	Black	-	CAT.5E 22AWG*2P+Drain+Filler+AL.Mylar	6.20	14.00	44.00
WCA00011527-17	LSZH	Green	-	CAT.6A S/FTP 26AWG*4P+AL/Polyester+Braid	6.60	17.99	47.08
WCA00010840	PVC	Black	-	CAT5E FTP 24AWG*4P+Mylar+D+AL.Mylar	6.50	17.97	47.34
WCA0373XX01	PVC	Beige	-	CAT5E FTP 24AWG*4P+Mylar+D+AL.Mylar	6.00	18.00	41.80
WCA0664UV01	PVC	Black	-	CAT5E FTP 24AWG*4P+Mylar+D+AL/Mylar	6.50	18.00	52.30
WCA0459XX01	PVC	Beige	-	CAT5E S-FTP 24AWG*4P+Mylar+AL.Mylar+D+B	6.10	30.97	55.00
WCA0663UV01	PVC	Black	-	CAT5E UTP 24AWG*4P	6.00	16.00	49.40
WCA00011688-03	PVC	Yellow	-	CL2 22AWG*2C+AL.Mylar+Drain+Braid	5.80	16.70	49.80
WCA0611XX01	PVC	Black	-	SJTW 14AWG*3C	9.50	56.70	154.50
WCA00010369	PVC	Black	-	STOOW 16AWG*4C	10.60	49.00	181.00
WCA00010899	PVC	Black	UL1277,UL1581,UL83	14AWG*3C+16AWG*1C	10.30	68.48	172.00
WCA00011252	PU	Black	UL20549	18AWG*2C+22AWG*4C+Filler+Paper	6.00	27.50	63.00
WCA00011253	PU	Black	UL20549	18AWG*2C+22AWG*6C+Filler+Paper	7.40	33.60	83.00
WCA00011254	PU	Black	UL20549	18AWG*2C+22AWG*8C+Filler+Paper	8.20	40.00	98.00
WCA00011582-43	PVC	Black	UL 21996	20AWG*2C+20AWG*3C	6.00	15.33	50.21
WCA0585UV01	PVC	Black	UL2464	24AWG*4C+20AWG*2C+Drain+AL.Mylar	6.00	22.40	57.40
WCA0042UV01	PVC	Black	UL2464	24AWG*6C+20AWG*2C+Drain+AL.Mylar	6.00	26.20	58.50
WCA0584UV01	PVC	Black	UL2464	26AWG*6C+24AWG*2C+Drain+AL.Mylar	5.50	13.70	42.80
WCA0365UV01	PVC	Black	-	28AWG*1P+24AWG*2C+AL.Mylar+Drain+Braid (USB2.0)	5.00	11.90	35.10
WCA00012165	PVC	Black	UL2725	28AWG*1P+28AWG*2C+AL.Mylar+Drain+Braid	3.80	10.00	21.00
WCA0691XX01	PVC	Black	UL2725	28AWG*1P+28AWG*3C+AL.Mylar+Drain+Braid	3.80	10.40	23.20
WCA00010259	PVC	Black	UL20276	[(18AWG*1P+AL)+(16AWG*1P+AL)]+Drain+AL+Braid	10.00	73.00	152.00
WCA00011922	PVC	Black	UL21996	(20AWG*1P+Drain+AL.Mylar)+16AWG*3C+Filler+AL.Mylar	8.50	50.61	115.27
WCA00010258	PVC	Black	-	[(22AWG*1P+AL)+(18AWG*1P+AL)]+Drain+AL.Mylar+Braid	7.00	42.00	80.00
WCA00010876	PVC	Black	UL2586	(24AWG*1P+A)*2C+16AWG*3C+EA	10.00	47.00	128.00
WCA00010257	PVC	Black	-	[(24AWG*1P+AL)+(22AWG*1P+AL)]+Drain+AL.Mylar+Braid	6.00	27.00	58.00
WCA00011350	PVC	Black	-	[(24AWG*1P+AL)+(22AWG*1P+AL)]+Drain+AL.Mylar+Braid	6.70	29.70	65.80
WCA00010437	PVC	Gray	-	[(24AWG*1P+AL)+(22AWG*1P+AL)]+Drain+Braid+Mylar	7.10	14.80	69.80
WCA00010080	PVC	Black	UL2464	(24AWG*25C+Mylar)+24AWG*25C+Drain+AL.Mylar	12.00	110.00	285.00
WCA00010710	PVC	Black	UL2464	(24AWG*2P+Drain+AL)+16AWG*3C+Filler+Paper	12.00	45.70	179.10
WCA00011923	PVC	Black	UL21996	(24AWG*2P+Drain+AL.Mylar)+12AWG*3C+Filler+AL.Mylar	11.50	99.97	187.20
WCA00010635	PVC	Black	UL2464	(24AWG*4P+Drain+AL)+16AWG*3C+Filler+Paper	11.00	41.70	149.70
WCA00010264	PVC	Black	UL20276	(26AWG*1P+Drain+AL.Mylar)*4C+26AWG*1P+26AWG*5C+AL.Mylar+Braid	8.50	45.50	94.30
WCA00011530-43	PVC	Black	UL21996	(26AWG*2P+AL.Mylar)+16AWG*2C+Filler+AL.Mylar	9.30	28.54	106.26
WCA00011531-43	PVC	Black	UL21996	(26AWG*2P+Drain+AL.Mylar)+16AWG*3C+Filler+AL.Mylar	11.00	41.58	146.60
WCA00011532-43	PVC	Black	UL21996	(26AWG*4P+Drain+AL.Mylar)+12AWG*3C+Filler+AL.Mylar	13.50	101.34	269.21
WCA00012137	PVC	Black	UL2725	(28AWG*1P+DAM)*2+28AWG*1P+28AWG*2C+Filler+AL.Mylar+Drain+Braid	6.00	21.80	48.20
WCA00010095	PVC	Black	UL20276	(28AWG*1P+Drain+AL+Mylar)*4C+(1P+3C)*28AWG+AL+Braid	7.30	33.90	73.70
WCA00010097	PVC	Black	UL20276	(28AWG*1P+Drain+AL+Mylar)*7C+28AWG*1P+28AWG*3C+AL+Braid	8.50	41.40	90.90
WCA00010081	PVC	Black	UL2464	[(28AWG*28C+Mylar)+28AWG*22C+Mylar]+28AWG*28C+Drain+AL	13.00	63.70	238.40
WCA00010096	PVC	Black	UL20276	[3COAX+(28AWG*1P+Drain+AL.Mylar+Mylar)*4+28AWG*1P+28AWG*6C]+AL.Mylar+Braid	8.50	53.50	93.10
WCA00010098	PVC	Black	UL20276	[3COAX+(28AWG*1P+Drain+AL+Mylar)*7+28AWG*1P+28AWG*6C]+AL+Braid	10.00	71.00	145.50
WCA00011960	PU	Black	UL20233	5C*2.5mm ² +Filler+Paper	10.20	116.00	191.00
WCA00011175	PU	Black	UL20549	8C*0.34mm ² +3C*1.0mm ² +Filler	8.60	54.00	116.00
WCA00011176	PU	Black	UL20549	16C*0.34mm ² +3C*1.0mm ² +Filler	9.70	79.00	161.00

Power-limited Circuit Cable

Specification

- Rated Voltage: 300V
- Temperature Range: FEP: 70 °C
PVC: 60 °C, 75 °C
- Test Voltage: 900Vac at 2 seconds
- Conductor Range: 28AWG ~ 10AWG
- Conductor Material Available: Standard Bare Copper
- Insulator Material Available: FEP/PVC
- Jacket Material: FEP/PVC
- O.D. Tolerance: > Ø17.8 mm



(UL) E489959-N CLXX XX AWG XX°C 300V

CLXX: UL13 Cable Type
 • Plenum Rated: (2P), (3P)
 • Riser Rated: (2R), (3R)
 • General Rated: (2), (3)
 • Residential Rated: (2X), (3X)

XX°C: Temperature Rating
 • FEP: (70)
 • PVC: (60), (75)

Features & Applications:

Type	Fire Resistance Level	UL Standard	CSA	Application
CL3P CL2P	Plenum Rated (Highest)	UL 910, CMP	FT6	• Ducts or plenums air handling space
CL3R CL2R	Riser Rated	UL 1666, CMR	-	• Vertical shafts in non-plenum areas • Cable runs more than one floor
CL3 CL2	General Purpose Rated	UL 1685, CMG/CM	FT4	• Power-limited circuit cable in non-plenum areas • Cable runs within one floor
CL3X CL2X	Residential Rated (Lowest)	VW-1, CMX	-	• Enclosed in non-plenum raceway or noncombustible tubing • Cable runs within one floor

Notes: UL File Number E489959; round or flat cable available

Find Our Standard Products

Part Number	WCA00011262-35	WCA00011263-35	WCA00011435-35	WCA00011282-35	WCA00011283-35	WCA00011272-35	WCA00011324-35
Cable Type	CL3P	CL3P	CL3P	CL3P	CL3P	CL3P	CL3P
Conductor	AWG	10	16	16	16	18	22
	No.	2	2	2	8	2	2
	Dia.	2.6	1.3	1.3	1.3	1.3	0.64
Insulation	Nom. Thick.	0.25mm	0.27mm	0.27mm	0.27mm	0.27mm	0.25mm
	Nom. Dia.	3.5±0.1mm	2.00±0.1mm	2.00±0.1mm	2.00±0.1mm	2.00±0.1mm	1.12±0.05mm
Jacket	Nom. Thick.	0.8mm	0.58mm	0.58mm	0.69mm	0.56mm	0.46mm
	Nom. Dia.	8.8±0.3mm	5.2±0.3mm	5.2±0.3mm	8.0±0.3mm	11.0±0.5mm	3.4±0.15mm
Conductor Resistance at 20°C (Max.)	3.41Ω/km	13.7Ω/km	13.7Ω/km	13.7Ω/km	13.7Ω/km	21.9Ω/km	55.4Ω/km

Other cable types and customization are available upon request.

UL 21996 Multiple-Conductor Cable Using Non-Integral Jacket

Specification

- Rated Voltage: 300V
- Temperature Range: -40°C ~ 105°C
- Test Voltage: 2000Vac at 1 minute
- Wet Temperature Rating: 60°C (Max.)
- Conductor Range: 30AWG ~ 10AWG
- Conductor Material Available: Tinned Copper
- Insulator Material Available: FEP/PVC
- Shielding Material Available: AL/Mylar: Coverage 100%, Overlap 25% (Min.) /
Braid: Tinned Copper, Overlap 65% (Min.) /
Spiral: Tinned Copper, Overlap 90% (Min.)
- Jacket Material: PVC
- O.D. Tolerance: > Ø17.8 mm
- Impedance: 100Ω ~ 120Ω ±15Ω



E489039-D VW AWM 21996 XX AWG -40°C 105°C 300V VW-1 AWM I/II A/B -40°C 105°C 300V FT1 Sun Res Wet 60°C Cable

Application

Internal wiring and external interconnection of electronic equipment. Suitable for outdoor use.

Features

- Reference standard: UL Subject 758, UL1581 & CSA C22.2 No.210.2
- Lead free PVC jacket
- Wide temperature range
- Sunlight resistant
- Passes UL VW-1(horizontal) & CSA FT1 (vertical) flammability tests
- Round or flat cable available
- Mixture, individual or paired conductors available
- UL File Number: E489039

Find Our Standard Products

Single Insulated Conductor Cable

Part Number		WCA00011581-43	WCA00011580-43	WCA00011548-43	WCA00011584-43	WCA00011583-43
Conductor	AWG	20	20	20	24	24
	No.	2	3	4	5	6
	Dia.	0.942mm	0.942mm	0.942mm	0.609mm	0.609mm
Insulation	Nom. Thick.	0.38mm	0.38mm	0.38mm	0.35mm	0.35mm
	Nom. Dia.	1.70±0.10mm	1.70±0.10mm	1.70±0.10mm	1.30±0.07mm	1.30±0.07mm
Shield	Style	-	-	-	-	Paper
	Overlap	-	-	-	-	25%
Conductor Resistance at 20°C (Max.)		34.6 / km	34.6 / km	34.6 / km	93.0 / km	93.0 / km
Jacket	Nom. Thick.	0.98mm	0.92mm	0.95mm	0.92mm	0.95mm
	Nom. Dia.	5.2±0.15mm	5.5±0.20mm	6.0±0.20mm	5.5±0.20mm	5.8±0.20mm

UL 21996 Multiple-Conductor Cable Using Non-Integral Jacket

Multi-conductor Cable

Part Number		WCA00011532-43		WCA00011530-43		WCA00011531-43		WCA00011582-43	
Component		A	B	A	B	A	B	A	B
Conductor	AWG	12	26	16	26	16	26	20	24
	No.	3	4	2	2	2	2	2	3
	Dia.	2.365mm	0.480mm	1.490mm	0.480mm	1.490mm	0.480mm	0.942mm	0.609mm
Insulation	Nom. Thick.	0.46mm	0.46mm	0.40mm	0.46mm	0.40mm	0.46mm	0.38mm	0.35mm
	Nom. Dia.	3.30±0.15mm	1.40±0.10mm	2.30±0.10mm	1.40±0.10mm	2.30±0.10mm	1.40±0.10mm	1.70±0.10mm	1.30±0.07mm
Shield	Style	-	Al. Mylar	-	Al. Mylar	-	Al. Mylar	-	Paper
	Overlap	-	25%	-	25%	-	25%	-	25%
Drain	AWG	-	26	-	-	-	26	-	-
	Dia.	-	0.480mm	-	-	-	0.480mm	-	-
Conductor Resistance at 20°C (Max.)		5.54 / km	148.0 / km	13.7 / km	148.0 / km	13.7 / km	148.0 / km	34.6 / km	93.0 / km
Jacket	Nom. Thick.	1.65mm		1.65mm		1.65mm		0.9mm	
	Nom. Dia.	13.5±0.40mm		9.3±0.25mm		11.0±0.30mm		6.0±0.20mm	
Impedance		120±15		120±15		120±15		-	

Customization is available upon request.

UL 21388 Jacket Cable

Specification

- Rated Voltage: 300V
- Temperature Range: ~ 80°C
- Test Voltage: 2000Vac at 1 minute
- Conductor Range: 30AWG ~ 10AWG
- Conductor Material Available: Tinned Copper
- Insulator Material Available: FEP/PVC/PE
- Shielding Material Available: AL/Mylar: Coverage 100%, Overlap 25% (Min.) /
Braid: Tinned Copper, Overlap 65% (Min.) /
Spiral: Tinned Copper, Overlap 90% (Min.)
- Jacket Material: PVC
- O.D. Tolerance: > Ø17.8 mm
- Impedance: 100Ω ~ 120Ω ±15Ω



E489039-D AWM 21388 XX AWG 80°C 300V VW-1 AWM I/II A/B 80°C 300V FT1 Sun Res Cable

Application

Internal wiring and external interconnection of electronic equipment. Suitable for outdoor use.

Features

- Reference standard: UL Subject 758, UL 1581 & CSA C22.2 No.210.2
- Lead free PVC jacket
- Wide temperature range
- Sunlight resistant
- Passes UL VW-1(horizontal) & CSA FT1 (vertical) flammability tests
- Round or flat cable available
- Mixture, individual or paired conductors available
- UL File Number: E489039

Find Our Standard Products

Part Number		WCA00011201-43	WCA00011202-43	WCA00011203-43	WCA00011204-43	WCA00011205-43	WCA00011184-43
Conductor	AWG	16	16	16	16	16	20
	No.	2	3	4	5	6	2
	Dia.	1.496mm	1.496mm	1.496mm	1.496mm	1.496mm	0.953mm
Insulation	Nom. Thick.	0.23mm	0.23mm	0.23mm	0.23mm	0.23mm	0.23mm
	Nom. Dia.	2.10±0.10mm	2.10±0.10mm	2.10±0.10mm	2.10±0.10mm	2.10±0.10mm	1.50±0.10mm
Shield	Style	Al. Mylar	Al. Mylar	Al. Mylar	Al. Mylar	Al. Mylar	Al. Mylar
	Overlap	25%	25%	25%	25%	25%	25%
Jacket	Nom. Thick.	0.76mm	0.76mm	0.76mm	0.76mm	0.76mm	0.76mm
	Nom. Dia.	6.00±0.20mm	6.50±0.20mm	6.80±0.20mm	7.60±0.20mm	8.40±0.20mm	5.50±0.20mm
Conductor Resistance at 20°C (Max.)		14.7 / km	14.7 / km	14.7 / km	14.7 / km	14.7 / km	36.7 / km

UL 21388 Jacket Cable

Find Our Standard Products

Part Number		WCA00011185-43	WCA00011186-43	WCA00011187-43	WCA00011188-43	WCA00011189-43	WCA00011190-43
Conductor	AWG	20	20	20	20	20	20
	No.	3	4	5	6	7	8
	Dia.	0.953mm	0.953mm	0.953mm	0.953mm	0.953mm	0.953mm
Insulation	Nom. Thick.	0.23mm	0.23mm	0.23mm	0.23mm	0.23mm	0.23mm
	Nom. Dia.	1.50±0.10mm	1.50±0.10mm	1.50±0.10mm	1.50±0.10mm	1.50±0.10mm	1.50±0.10mm
Shield	Style	Al. Mylar	Al. Mylar	Al. Mylar	Al. Mylar	Al. Mylar	Al. Mylar
	Overlap	25%	25%	25%	25%	25%	25%
Jacket	Nom. Thick.	0.76mm	0.76mm	0.76mm	0.76mm	0.76mm	0.76mm
	Nom. Dia.	5.50±0.20mm	6.00±0.20mm	6.20±0.20mm	6.80±0.20mm	6.80±0.20mm	7.20±0.20mm
Conductor Resistance at 20°C (Max.)		36.7 / km	36.7 / km	36.7 / km	36.7 / km	36.7 / km	36.7 / km

Part Number		WCA00011191-43	WCA00011192-43	WCA00011193-43	WCA00011200-43	WCA00011194-43
Conductor	AWG	20	20	20	20	20
	No.	9	10	12	14	18
	Dia.	0.953mm	0.953mm	0.953mm	0.953mm	0.953mm
Insulation	Nom. Thick.	0.23mm	0.23mm	0.23mm	0.23mm	0.23mm
	Nom. Dia.	1.50±0.10mm	1.50±0.10mm	1.50±0.10mm	1.50±0.10mm	1.50±0.10mm
Shield	Style	Al. Mylar	Al. Mylar	Al. Mylar	Al. Mylar	Al. Mylar
	Overlap	25%	25%	25%	25%	25%
Jacket	Nom. Thick.	0.76mm	0.76mm	0.76mm	0.76mm	0.76mm
	Nom. Dia.	7.60±0.20mm	8.50±0.25mm	8.50±0.25mm	8.50±0.20mm	10.0±0.30mm
Conductor Resistance at 20°C (Max.)		36.7 / km	36.7 / km	36.7 / km	36.7 / km	36.7 / km

Customization is available upon request.

UL 2464 Multiple-Conductor Cable

Using Non-Integral Jacket

Specification

- Rated Voltage: 300V
- Temperature Range: ~ 80°C
- Test Voltage: 2000Vac at 1 minute
- Conductor Range: 30AWG ~ 10AWG
- Conductor Material Available: Tinned Copper
- Insulator Material Available: FEP/PVC/PE
- Shielding Material Available: AL/Mylar: Coverage 100%, Overlap 25% (Min.) /
Braid: Tinned Copper, Overlap 65% (Min.) /
Spiral: Tinned Copper, Overlap 90% (Min.)
- Jacket Material: PVC
- O.D. Tolerance: > Ø17.8 mm
- Impedance: 100Ω ~ 120Ω ±15Ω



E489039-D  AWM 2464 XX AWG 80°C 300V VW-1  AWM I/II A/B 80°C 300V FT1 Cable

Application

Internal wiring and external interconnection of electronic equipment. Suitable for outdoor use.

Features

- Reference standard: UL Subject 758, UL 1581 & CSA C22.2 No.210.2
- Lead free PVC jacket
- Wide temperature range
- Sunlight resistant
- Passes UL VW-1(horizontal) & CSA FT1 (vertical) flammability tests
- Round or flat cable available
- Mixture, individual or paired conductors available
- UL File Number: E489039

Question

Our most popular FAQs will help you to easily find the answers you need.



Q: What connectors can be used for power and signal distribution?

A: CERES, SENSOR, X-LOK, RBL and HS-Lok connectors. For more detailed information and guide, please refer "Product Summary Table"

Q: Can ALTW connectors be used in direct burial?

A: No, they are not designed for this type of application. They should be routed inside a conduit or other means of reinforcement if deployed underground.

Q: Can ALTW connectors be used in continuous water immersion?

A: No, there is a limitation for their immersion to water as defined on each IP rating. Only "Deeptronica" series can be used in permanent immersion.

Q: Why are ALTW connectors called waterproof if they can only be immersed for a certain period? Shouldn't they be called water resistant?

A: As long as the immersion period does not surpass the conditions specified on the IP rating, they can be referred as waterproof.

Q: What is the Ingress Protection (IP) of ALTW connectors?

A: It ranges from IP65 to IP69K.

Q: Can ALTW connectors be connected/disconnected under load?

A: By default, only connectors for data (RJ45, DVI, HDMI, and USB) can be used in hot-plugging. Power connectors need to be customized to achieve this.

FAQ

Q: Do ALTW connectors comply with MIL STD?

A: No, ALTW connectors are only evaluated under EIA, IEC and UL standards.

Q: What connectors can be used in high-speed base band data transmission?

A: Ceres, X-Lok, M12 D & X-coded, RJ45, DVI, HDMI, USB and FLOS connectors.

Q: Can ALTW connectors be customized to meet certain requirements?

A: Yes, connectors can be customized to meet customer requirements. If a certification is required, it will be applied. If not, ALTW can provide in-house test reports as a confirmation that the pre-defined specifications have been met.

Q: Do ALTW connectors have ATEX certification?

A: No. ALTW connectors are not yet certified by ATEX.

Q: What is the difference between Oleophobic and Hydrophobic protective vents? What is the main function of the vent?

A: These properties refer to the fluid resistance of the membrane in the vent. Hydrophobic means that the membrane is water repelling, while Oleophobic means the membrane is oil repelling.

They are used in applications that require the balancing of internal and external pressures such as electrical cabinets, wireless access points, control hubs and junction boxes. The trapped air inside the enclosures expands or contracts relative to the heat emitted by the components it encloses and the external ambient temperatures.



If your question is not answered here, please contact Amphenol LTW Customer Service or browse for more information on our website. www.amphenol.tw.com

Scan here to contact us or e-mail us at sales@ltw-tech.com

UV Resistant

Being resistant to ultraviolet light (UV), or sunlight, means being able to withstand or resist the degradation caused by ultraviolet light.

UV light causes non-resistant materials and surfaces to fade or discolor.

Flammability

The ability of a chemical to burn or ignite, causing fire or combustion. The degree of difficulty required to cause the combustion of a chemical is quantified through fire testing.

Flammability can be classified as low (least flame-retarded) to high (most flame-retarded). From lowest to highest it is classified as follows:

- HB - horizontal slow burning: Burning rate under 76mm/min for a thickness below 3mm or the burning stops before 100mm
 - V-2: Burning stops within 30 seconds on a vertical specimen and drips of flaming particles are allowed
 - V-1: Burning stops within 30 seconds on a vertical specimen and drips of particles are allowed as long as they are not inflamed
 - V-0: Burning stops within 10 seconds on a vertical specimen and drips of particles are allowed as long as they are not inflamed
-

IEC

The International Electrotechnical Commission (IEC) is the world's leading organization for the preparation and publication of international standards for all electrical, electronic and related technologies. These are known collectively as “electrotechnology”.

The IEC provides a platform for companies, industries and governments to meet, discuss and develop the international standards they require. All IEC standards are consensus-based and represent the needs of the key stakeholders of every nation participating. Every member country has a vote on what is included into an IEC international standard.

LEXICON

UL 50e

This standard applies to enclosures for electrical equipment intended to be installed and used in non-hazardous locations. It covers additional environmental construction and performance requirements for enclosures.

UL 1863

This standard applies to Safety Communication - circuit Accessories. It covers telecommunications-circuit accessories, such as jack and plug assemblies, quick-connect terminal assemblies, telephone wall plates, telephone extension cords, cross-connect terminal-block assemblies, maintenance terminal modules, terminal enclosures, cable-splice enclosures, network-interface devices, wire-guide assemblies, and connector boxes.

UL 1977

These requirements cover single and multipole connectors intended for factory assembly to copper or copper alloy conductors or printed wiring boards for use in data, signal, control and power applications within and between electrical equipment.

UL 2237

This standard covers multi-point interconnection power cable assemblies. They may consist of power cable assemblies, male or female power cable fittings, panel-mounted power cable/conductor fittings and feeder-tap power cable fittings, referred to as the device in this standard, used with industrial machinery in accordance with the National Fire Protection Association Electrical Standard for Industrial Machinery, NFPA 79 that have system voltages up to and including 1,000 V.

UL 2238

These requirements cover devices intended for inter-connection of equipment, sensors, and actuators in remote-control, signaling, and power-limited circuits. Included are cable assemblies and fittings, feeder-tap cable systems, feed-through connectors, multi-outlet fittings, panel-mount fittings, and splitters. These devices are rated not more than 60 A and not more than 600 V. These devices are not intended for disconnect means.

LEXICON

LV214

This automotive standard was developed by German car manufacturers Audi, BMW, Daimler, Porsche and Volkswagen. It addresses the ability of terminals to be effectively evaluated by crimp force monitors. The terminals must exhibit certain crimp force to be used in an automotive wire harness.

Fasten Style of Nut

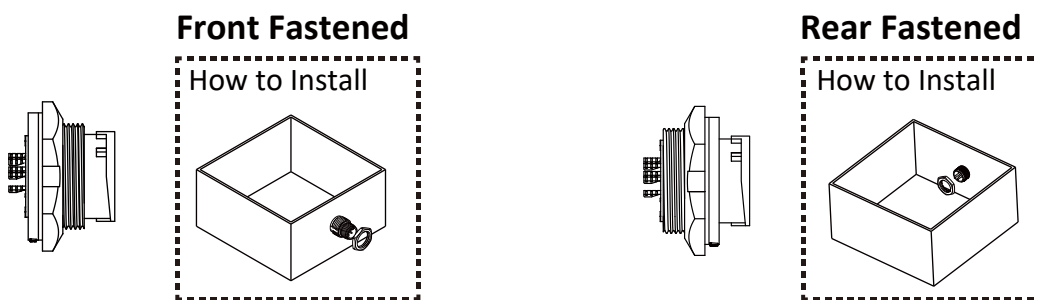

Mating Style

Screw Thread

- Ceres
- RJ45
- FICX
- Power
- USB
- Cable Joiner
- M Series
- HDMI
- Cable Gland
- NMEA
- RF
- LED In.
- D-Sub
- DVI
- Vent

2 Points Lock Bayonet

- Ceres
- Power
- USB

3 Points Lock Bayonet

- Ceres
- Power
- RJ45
- Fiber

Push Pull

- M Series
- FLO & FLOS+
- HS-Lok
- USB

Push Lock With Latches

- RBL
- D-Sub
- SSL

Push Lock

- X-Lok
- USB

Termination Style



LEXICON

ODVA

ODVA is a global association whose members comprise of world's leading automation companies. ODVA's mission is to advance open, interoperable information and communication technologies in industrial automation. The association recognizes its media independent network protocol, the Common Industrial Protocol or "CIP" – and the network adaptations of CIP – EtherNet/IP, DeviceNet, CompoNet and ControlNet – as its core technology and the primary common interest of its membership.

ODVA's vision is to contribute to the sustainability and prosperity of the global community by transforming the model for information and communication technology in the industrial ecosystem.

NMEA 2000

NMEA 2000 is a protocol used to create a network of electronic devices – mainly marine instruments – on a boat. Various instruments that meet the NMEA 2000 standard are connected to one central cable, known as a backbone. The backbone powers each instrument and relays data among all the instruments on the network. This allows one display unit to show many different types of information and allows the instruments to work together. NMEA 2000 is meant to be "plug and play" to allow devices made by different manufacturers to talk and listen to each other.

Amphenol LTW's IPCS (Intelligent Pre-cabling Systems)

Amphenol LTW Intelligent Pre-Cabling System (IPCS) is your solution for the LED Lighting incorporation in indoor and outdoor applications. With a simplified design and wide flexibility, IPCS solves all your needs for electrical wiring and cabling infrastructure. It also provides large savings in on-site installation time and cost. The concept of IPCS is suitable for ALTW's various connector series, ideal for a large variety of customization.

Amphenol LTW's Power / Data / Hybrid Solutions

We are dedicated to developing interconnect solution to fulfill customer requirements of power or data applications, and as devices increasingly carry more functions in reduced spaces, Hybrid solutions are the answer to space limitation and multi-function. Below is the product series for Power, Data, and Hybrid applications.

0.5A ~ 2A

- Ceres
- X-Lok
- M Series
- D-Sub
- DVI
- HDMI
- USB
- HS-Lok
- FLO & FLOS+

3A ~ 5A

- Ceres
- X-Lok
- M Series
- D-Sub
- SSL
- RBL
- HS-Lok
- FLO & FLOS+
- NMEA 2000
- USB

6A ~ 10A

- Ceres
- X-Lok
- Power
- M Series
- Mini
- RBL
- FLO & FLOS+
- NMEA 2000
- USB
- FICX

11A ~ 20A

- Ceres
- X-Lok
- Power
- M Series
- FICX
- RBL
- FLO & FLOS+
- Mini
- FICX

25A ~ 30A

- Power
- FLO & FLOS+
- M Series

50A

- Power
- X-Lok

80A

- Power

Cross Section Conversion From AWG To mm²

26 AWG	0.14 mm ²	16 AWG	1.50 mm ²	4 AWG	25.00 mm ²
24 AWG	0.25 mm ²	14 AWG	2.50 mm ²	2 AWG	35.00 mm ²
22 AWG	0.34 mm ²	12 AWG	4.00 mm ²	1 AWG	50.00 mm ²
20 AWG	0.50 mm ²	10 AWG	6.00 mm ²	2/0 AWG	70.00 mm ²
18 AWG	0.75 mm ²	8 AWG	10.00 mm ²		
17 AWG	1.00 mm ²	6 AWG	16.00 mm ²		

Ingress Protection (IP) Rating Guide

Waterproof Definition

Unmated Waterproof



Standalone waterproof or waterproof is assured even without its counterpart. The water will not go through the inner portion of the exposed connector as it is entirely sealed.

Mated Waterproof





Waterproof is only assured when mated and locked tightly to its counterpart.

1st Digit - SOLIDS

Degree of protection against solid objects

 No Protection **0**

 Protected against a solid object greater than 50mm, such as a hand. **1**

 Protected against a solid object greater than 12.5mm, such as a finger. **2**

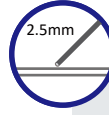
 Protected against a solid object greater than 2.5mm, such as a wire. **3**

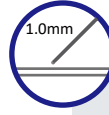
 Protected against a solid object greater than 1.0mm, such as a thin strap. **4**

 Dust Protected. Prevents ingress of dust sufficient to cause harm. **5**

 Dust tight. No ingress of dust. **6**

2nd Digit - LIQUIDS

Degree of protection against water

 No Protection **0**

 Protected against water drops. **1**

 Protected against water drops at a 15 degree angle. **2**

 Protected against water spray at a 60 degree angle. **3**

 Protected against water splashing from any angle. **4**

 Protected against water jets from any angle. **5**

 Protected against powerful water jets and heavy seas. **6**

 Protected against the effects of temporary submersion in water (30 minutes at 3 feet). **7**

 Protected against the effects of permanent submersion in water (up to 13 feet). **8**

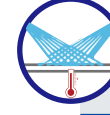
 Protection against close range, powerful and high temperature water jets. **9K**

Example:



IP 65

→ Protected against water jets from any angle.

→ Dust tight. No ingress of dust.

Amphenol LTW Technology Co., Ltd.

5F-3, No.51, Sec.4, Zhongyang Rd., Tucheng Dist., New Taipei City 236 Taiwan

Telephone : +886-2-7741-6888 Fax : +886-2-7741-6999

Email : sales@ltw-tech.com Web: amphenolltw.com

Kunshan Factory

No.62, DaTong Road, Development Zone, Kunshan City, JiangSu Province 215333 China

Telephone : +86-512-5761-0501 Fax : +86-512-5761-0515

For further information, please contact :

Luc Kan | Sales and Marketing

Email : luc@ltw-tech.com

