

# XS4P30PA370L01B

Inductive proximity sensors XS, inductive sensor XS4 M30, L62mm, PPS, Sn15mm, 12...48 VDC, term. 0.15 m



## Main

Range of product	Telemecanique Inductive proximity sensors XS
Series name	General purpose
Sensor type	Inductive proximity sensor
Sensor name	XS4
Sensor design	Cylindrical M30
Size	62 mm
Body type	Fixed
Detector flush mounting acceptance	Non flush mountable
Material	Plastic
Type of output signal	Discrete
Wiring technique	3-wire
[Sn] nominal sensing distance	15 mm
Discrete output function	1 NO
Output circuit type	DC
Discrete output type	PNP
Electrical connection	Remote male connector screw-clamp terminals
Cable length	0.15 m
[Us] rated supply voltage	12...48 V DC with reverse polarity protection
Switching capacity in mA	<= 200 mA DC with overload and short-circuit protection
IP degree of protection	IP68 double insulation conforming to IEC 60529

## Complementary

Thread type	M30 x 1.5
Detection face	Frontal
Front material	PPS
Enclosure material	PPS
Operating zone	0...12 mm
Differential travel	1...15% of Sr
Cable composition	3 x 0.34 mm <sup>2</sup>
Wire insulation material	PVC
Status LED	Output state: 1 LED (yellow)
Supply voltage limits	10...58 V DC
Switching frequency	<= 1000 Hz
Maximum voltage drop	<2 V (closed)
Current consumption	0...10 mA no-load
Maximum delay first up	10 ms
Maximum delay response	0.3 ms
Maximum delay recovery	0.7 ms
Marking	CE
Threaded length	52 mm
Height	30 mm
Length	62 mm

## Environment

Product certifications	UL CCC CSA
Ambient air temperature for operation	-25...70 °C
Ambient air temperature for storage	-40...85 °C
Vibration resistance	25 gn amplitude = +/- 2 mm (f = 10...55 Hz) conforming to IEC 60068-2-6
Shock resistance	50 gn for 11 ms conforming to IEC 60068-2-27

## Packing Units

Unit Type of Package 1	PCE
Number of Units in Package 1	1
Package 1 Height	4.2 cm
Package 1 Width	9.7 cm
Package 1 Length	13.2 cm
Package 1 Weight	132.0 g
Unit Type of Package 2	S01
Number of Units in Package 2	10
Package 2 Height	15 cm
Package 2 Width	15 cm
Package 2 Length	40 cm
Package 2 Weight	1.516 kg

## Offer Sustainability

Sustainable offer status	Green Premium product
REACH Regulation	<a href="#">REACH Declaration</a>
EU RoHS Directive	Pro-active compliance (Product out of EU RoHS legal scope) <a href="#">EU RoHS Declaration</a>
Mercury free	Yes
RoHS exemption information	<a href="#">Yes</a>
Environmental Disclosure	<a href="#">Product Environmental Profile</a>
Circularity Profile	<a href="#">End Of Life Information</a>

## Contractual warranty

Warranty	18 months
----------	-----------

Dimensions

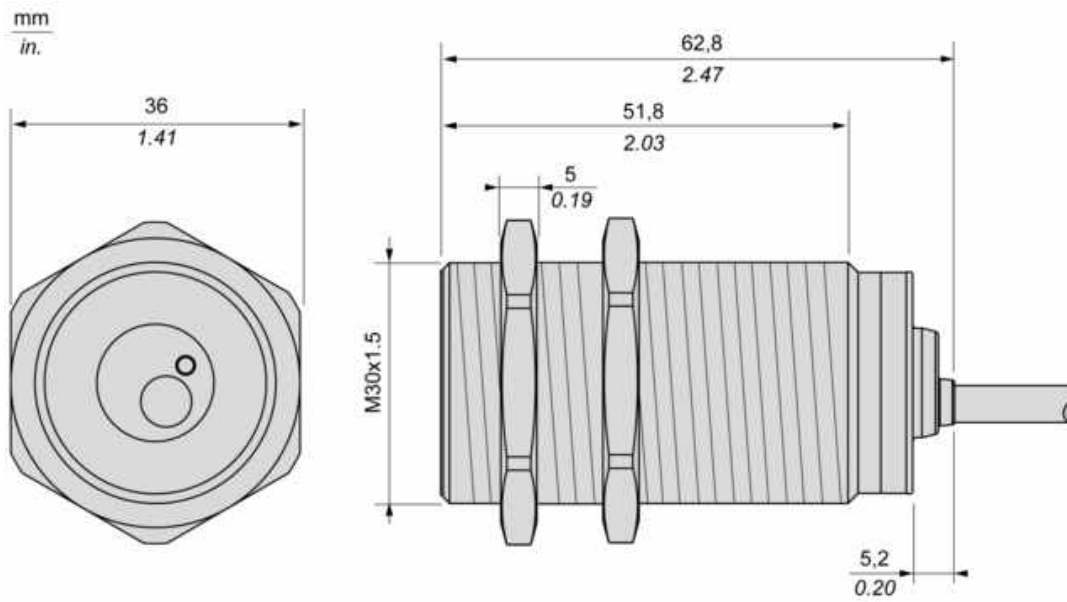

Minimum Mounting Distances

Side by side

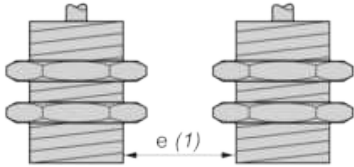

$e (1) \geq 60 \text{ mm} / 2.36 \text{ in.}$

Face to face

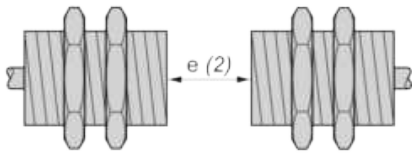

$e (2) \geq 180 \text{ mm} / 7.09 \text{ in.}$

Facing a metal object

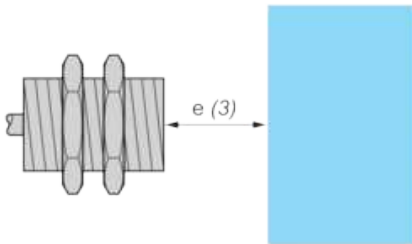

$e (3) \geq 45 \text{ mm} / 1.77 \text{ in.}$

Mounted in a metal support

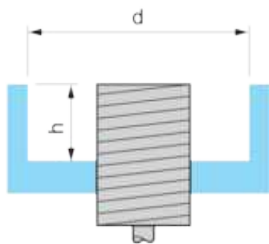

$d \geq 90 \text{ mm} / 3.54 \text{ in.}$

$h \geq 30 \text{ mm} / 1.18 \text{ in.}$

---

Wiring Schemes

---

Screw Terminal

The terminal numbering differs according to the version (2-wire DC, 3-wire DC, 2-wire AC).

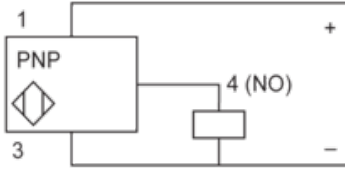

---

Performance Curves

---

Standard Steel Target : 45x45x1 mm

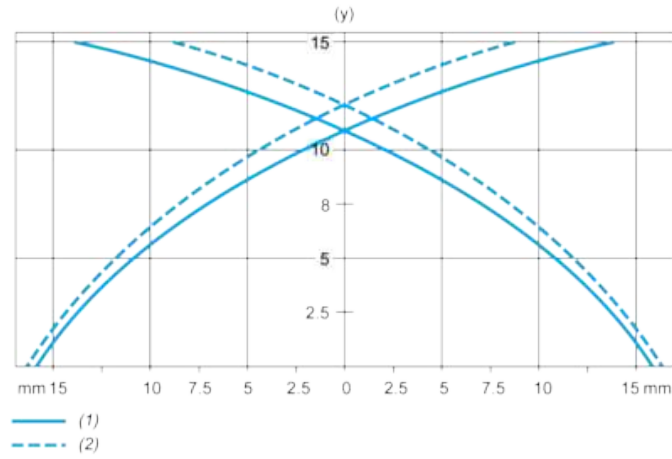

(1) Pick-up points

(2) Drop-out points (object approaching from the side)

(y) Sensing distance in mm