

# XPSUEP14AP

Safety module, Harmony Safety Automation,  
Cat.4, Expansion use with Universal range, 24V  
AC/DC, screw



## Main

Range of product	Harmony Safety Automation
Product or component type	Safety module
Safety module name	XPSUEP
Safety module application	For extending number of safety contacts
Function of module	Safety output extension
Safety level	Can reach PL e/category 4 for normally open relay contact conforming to ISO 13849-1 Can reach SILCL 3 for normally open relay contact conforming to IEC 62061 Can reach SIL 3 for normally open relay contact conforming to IEC 61508 Can reach PL c/category 1 for normally closed relay contact conforming to ISO 13849-1 Can reach SILCL 1 for normally closed relay contact conforming to IEC 62061 Can reach SIL 1 for normally closed relay contact conforming to IEC 61508
Safety reliability data	MTTFd > 30 years conforming to ISO 13849-1 Dcavg >= 99 % conforming to ISO 13849-1 PFHd = 0.97E-09 conforming to ISO 13849-1 HFT = 1 conforming to IEC 62061 PFHd = 0.97E-09 conforming to IEC 62061 SFF > 99% conforming to IEC 62061 HFT = 1 conforming to IEC 61508-1 PFHd = 0.97E-09 conforming to IEC 61508-1 SFF > 99% conforming to IEC 61508-1 Type = B conforming to IEC 61508-1
Electrical circuit type	Addition to Preventa XPSU base module
Connections - terminals	Removable screw terminal block, 0.2...2.5 mm <sup>2</sup> solid or flexible Removable screw terminal block, 0.25...2.5 mm <sup>2</sup> flexible with ferrule single conductor Removable screw terminal block, 0.2...1.5 mm <sup>2</sup> solid or flexible twin conductor Removable screw terminal block, 2 x 0.25...1 mm <sup>2</sup> flexible with ferrule without cable end, with bezel Removable screw terminal block, 2 x 0.5...1.5 mm <sup>2</sup> flexible with ferrule with cable end, with bezel
[Us] rated supply voltage	24 V AC - 15...10 % 24 V DC - 20...20 %

## Complementary

Power consumption in W	1.5 W 24 V DC
Power consumption in VA	3.5 VA 24 V AC 50/60 Hz
Input protection type	Internal, electronic
Safety outputs	4 NO redundant 2 NC single
Safety inputs	0 extension bus 24 V DC 5 mA
Maximum line resistance	60 Ohm

The information provided in this documentation contains general descriptions and/or technical characteristics of the performance of the products contained herein. This documentation is not intended as a substitute for and is not to be used for determining suitability or reliability of these products for specific user applications. It is the duty of any such user or integrator to perform the appropriate and complete risk analysis, evaluation and testing of the products with respect to the relevant specific application or use thereof. Neither Schneider Electric Industries SAS nor any of its affiliates or subsidiaries shall be responsible or liable for misuse of the information contained herein.

Input compatibility	Normally closed circuit conforming to ISO 14119 XC limit switch conforming to ISO 14119 Mechanical contact conforming to ISO 14119 Normally closed circuit conforming to ISO 13850 Antivalent pair conforming to ISO 14119 OSSD pair conforming to IEC 61496-1-2 3-wire proximity sensors PNP
[Ie] rated operational current	5 A AC-1 for normally open relay contact 3 A AC-15 for normally open relay contact 5 A DC-1 for normally open relay contact 3 A DC-13 for normally open relay contact
[Ith] conventional free air thermal current	8 A
Associated fuse rating	10 A gG for NO relay output circuit conforming to IEC 60947-1 4 A gG for NC relay output circuit conforming to IEC 60947-1
Minimum output current	10 mA for relay output
Minimum output voltage	12 V for relay output
Maximum response time on input open	20 ms
[Ui] rated insulation voltage	250 V (pollution degree 2) conforming to EN/IEC 60947-1
[Uimp] rated impulse withstand voltage	4 kV overvoltage category II conforming to EN/IEC 60947-1
Local signalling	LED (green) for power ON LED (red) for error LED (yellow) for safety output status
Mounting support	35 mm symmetrical DIN rail
Depth	120 mm
Height	100 mm
Width	22.5 mm
Net weight	0.200 kg

## Environment

Standards	IEC 60947-5-1 IEC 61508-1 functional safety standard IEC 61508-2 functional safety standard IEC 61508-3 functional safety standard IEC 61508-4 functional safety standard IEC 61508-5 functional safety standard IEC 61508-6 functional safety standard IEC 61508-7 functional safety standard ISO 13849-1 functional safety standard IEC 62061 functional safety standard
Product certifications	TÜV cULus
IP degree of protection	IP20 (terminals) conforming to EN/IEC 60529 IP40 (housing) conforming to EN/IEC 60529 IP54 (mounting area) conforming to EN/IEC 60529
Ambient air temperature for storage	-25...85 °C
Relative humidity	5...95 % non-condensing

## Packing Units

Unit Type of Package 1	PCE
Number of Units in Package 1	1
Package 1 Height	6.5 cm
Package 1 Width	13.5 cm
Package 1 Length	15.5 cm
Package 1 Weight	283.0 g
Unit Type of Package 2	S03
Number of Units in Package 2	16
Package 2 Height	30 cm
Package 2 Width	30 cm
Package 2 Length	40 cm
Package 2 Weight	5.419 kg

## Offer Sustainability

Sustainable offer status	Green Premium product
REACH Regulation	<a href="#">REACH Declaration</a>
EU RoHS Directive	Pro-active compliance (Product out of EU RoHS legal scope) <a href="#">EU RoHS Declaration</a>
Mercury free	Yes
China RoHS Regulation	<a href="#">China RoHS Declaration</a>
RoHS exemption information	<a href="#">Yes</a>
Environmental Disclosure	<a href="#">Product Environmental Profile</a>
Circularity Profile	<a href="#">End Of Life Information</a>
WEEE	The product must be disposed on European Union markets following specific waste collection and never end up in rubbish bins
PVC free	Yes

## Contractual warranty





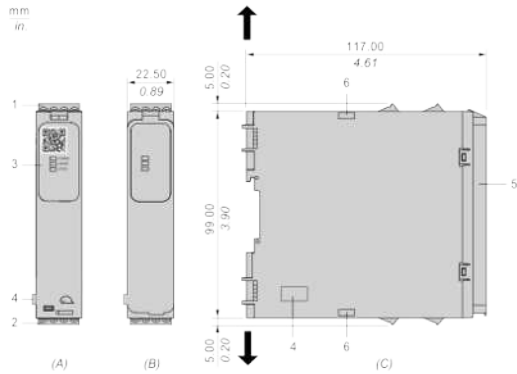

Warranty	18 Monate
----------	-----------

Dimensions

Front and Side Views



- (A) : Product drawing
- (B) : Screw clamp terminal
- (C) : Side view
- (1) : Removable terminal blocks, top
- (2) : Removable terminal blocks, bottom
- (3) : LED indicators
- (4) : Connector for base safety module
- (5) : Sealable transparent cover
- (6) : Position of clips for mounting to base safety module

mm in.	7.0-8.0 0.28-0.31					
mm <sup>2</sup>	0.2... 2.5	0.25...2.5	0.2...1.5	0.25...1	0.5...1.5	
AWG	24... 12	24...12	24...16	24...18	20...16	
	Ø 3,5 mm (0.14 in)			Nm	0.5... 0.6	
				lb-in	4,4... 5,3	

## Mounting to DIN rail

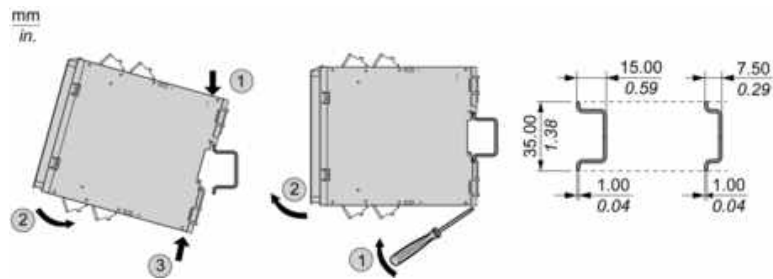

## Screw-mounting

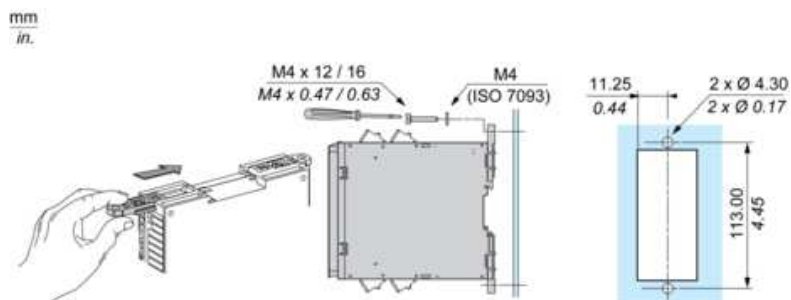

## Wiring Drawing

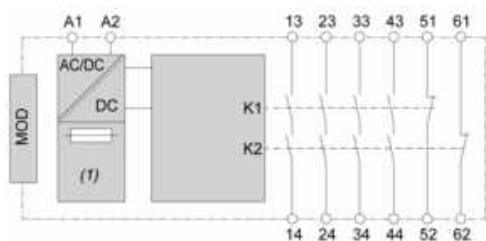

(1) : A1-A2 (Power supply)

13-23-33-43-51-61-14-24-34-44-52-62 : Output

MOD : Connector for base safety module