

SERIES: VX78-1000R | **DESCRIPTION:** NON-ISOLATED DC SWITCHING REGULATOR

FEATURES

- wide input
- pin-out compatible with linear regulators
- encapsulated
- UL & CSA approved
- high efficiency up to 96%
- no-load input current as low as 0.2 mA
- wide operating temp: -40°C to +85°C
- supports negative output
- short circuit protection on the output



MODEL

MODEL	input voltage ¹		output voltage (Vdc)	output current max (mA)	output power max (W)	ripple & noise ² max (mVp-p)	efficiency typ (%)
	typ (Vdc)	range (Vdc)					
VX7803-1000R	24	6~36	3.3	1000	3.3	75	90
VX7805-1000R	24	8~36	5	1000	5	75	93
	12	8~27	-5	-500	2.5	75	86
VX7809-1000R	24	13~36	9	1000	9	75	95
VX7812-1000R	24	16~36	12	1000	12	75	96
	12	8~20	-12	-300	3.6	75	89
VX7815-1000R	24	20~36	15	1000	15	75	96
	12	8~18	-15	-300	4.5	75	89

Note: 1. For input voltage exceeding 30 VDC, an input capacitor of 22uF/50V is required
 2. 20MHz bandwidth, nominal input, 20%-100% load. With light loads at or below 20%, ripple and noise for 3/3V/5V output parts increases to 100mVp-p and for 9V/12V/15V output parts to 2%Vo max.

PART NUMBER KEY

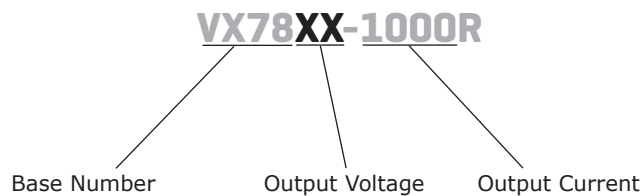

INPUT

parameter	conditions/description	min	typ	max	units
filter	capacitor filter				
no-load input current	positive outputs		0.1	1	mA

OUTPUT

parameter	conditions/description	min	typ	max	units
maximum capacitive load	for positive output applications for negative output applications			680 330	μ F μ F
voltage accuracy	at full load, input voltage range 3.3 Vdc output model all other models		± 2 ± 2	± 4 ± 3	% %
line regulation	at full load, input voltage range		± 0.2	± 0.4	%
load regulation	at nominal input, 10~100% load		± 0.4	± 0.6	%
switching frequency	at nominal input voltage, full load 3.3/5 Vdc output models all other models	420 580	520 680	620 780	kHz kHz
transient recovery time	at nominal input voltage, 25% load step change		0.1	1	ms
transient response deviation	at nominal input voltage, 25% load step change		50	300	mV
temperature coefficient	Operating ambient temperature -40°C to +85°C			± 0.03	%/°C

PROTECTIONS

parameter	conditions/description	min	typ	max	units
short circuit protection	continuous, auto recovery				

SAFETY AND COMPLIANCE

parameter	conditions/description	min	typ	max	units
safety approvals	UL 60950-1				
conducted emissions	CISPR22/EN55022, class B (external circuit required, see Figure 4-b)				
radiated emissions	CISPR22/EN55022, class B (external circuit required, see Figure 4-b)				
ESD	IEC/EN61000-4-2, contact ± 4 kV, criteria B				
radiated immunity	IEC/EN61000-4-3, 10V/m, criteria A				
EFT/burst	IEC/EN61000-4-4, ± 1 kV, criteria B (external circuit required, see Figure 4-a)				
surge	IEC/EN61000-4-5, line-line ± 1 kV, criteria B (external circuit required, see Figure 4-a)				
conducted immunity	IEC/EN61000-4-6, 3 Vr.m.s, criteria A				
MTBF	as per MIL-HDBK-217F, 25°C		2,000,000		hours
RoHS	yes				

ENVIRONMENTAL

parameter	conditions/description	min	typ	max	units
operating temperature	see derating curve	-40		85	°C
storage temperature		-55		125	°C
storage humidity	non-condensing	5		95	%

MECHANICAL

parameter	conditions/description	min	typ	max	units
dimensions	11.50 x 9.00 x 17.50 [0.453 x 0.354 x 0.689 inch]				mm
case material	black flame-retardant heat-proof plastic (UL94V-0)				
weight			3.8		g

MECHANICAL DRAWING

units: mm [inch]
 tolerance: $\pm 0.25[\pm 0.010]$
 pin diameter tolerance: $\pm 0.10[\pm 0.004]$

PIN CONNECTIONS		
PIN	+OUTPUT	-OUTPUT
1	+VIN	+VIN
2	GND	-VOUT
3	+VOUT	GND

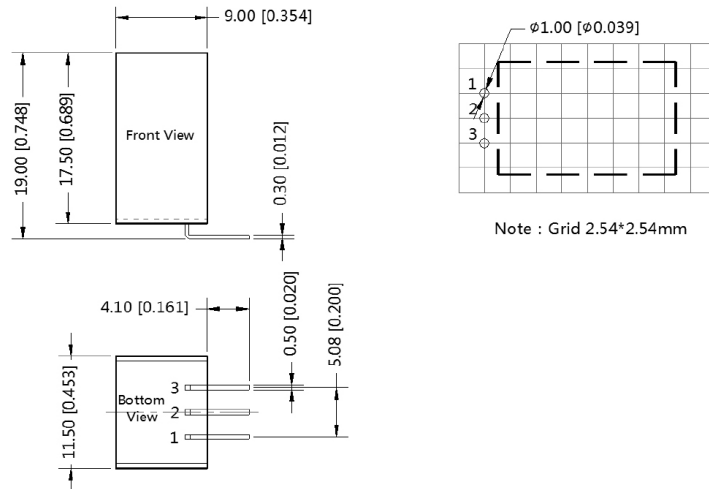

DERATING CURVE

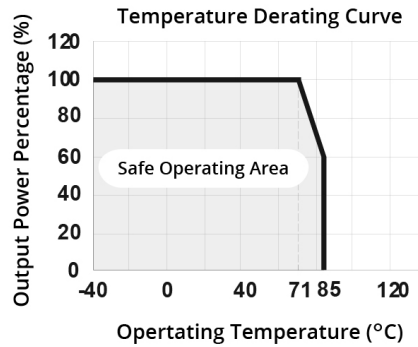

EFFICIENCY CURVES

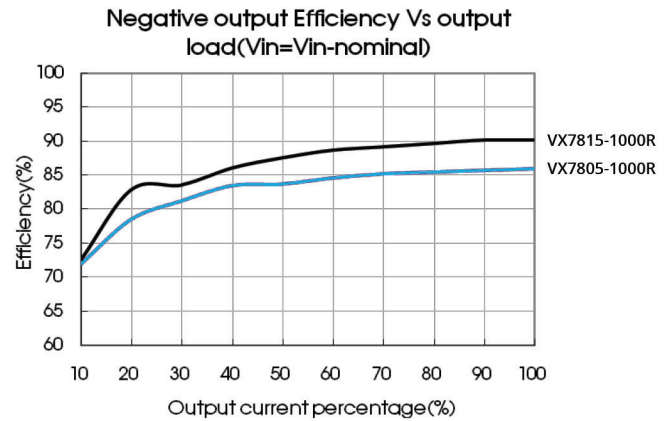
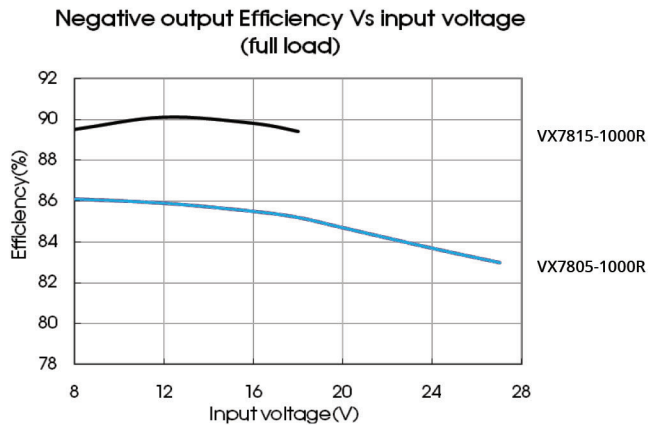
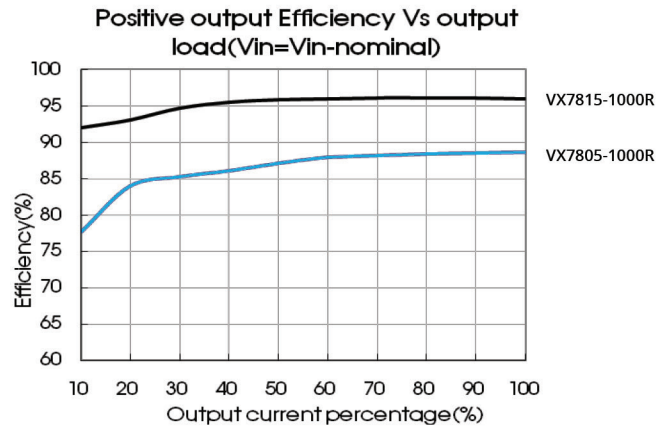
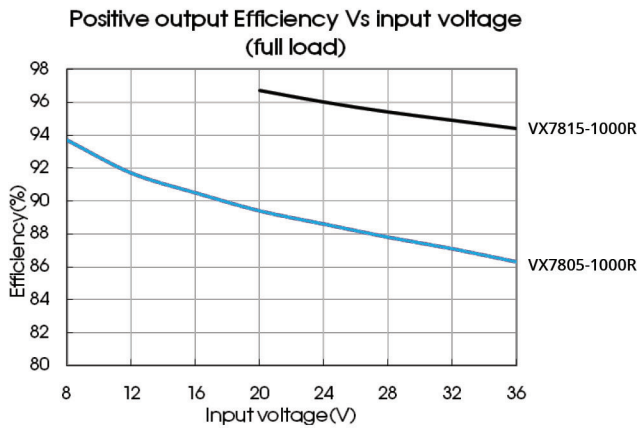

TYPICAL APPLICATION CIRCUIT

Figure 1

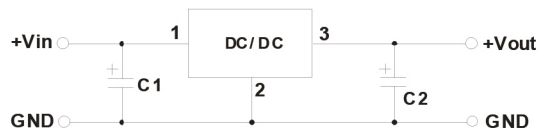

Positive output application circuit

Figure 2

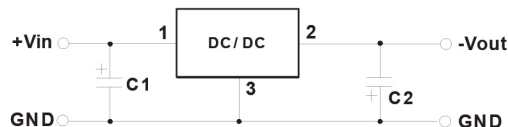

Negative output application circuit

Figure 3

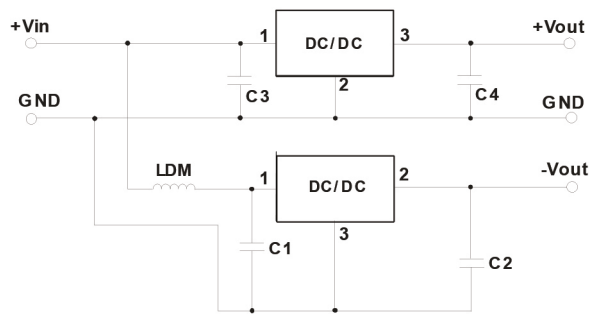

Positive and Negative output application circuit

Table 1

External Capacitor Table

Model Number	C1, C3 (ceramic capacitor)	C2, C4 (ceramic capacitor)
VX7803-1000R	10 μ F/50 V	22 μ F/10 V
VX7805-1000R	10 μ F/50 V	22 μ F/10 V
VX7809-1000R	10 μ F/50 V	22 μ F/16 V
VX7812-1000R	10 μ F/50 V	22 μ F/25 V
VX7815-1000R	10 μ F/50 V	22 μ F/25 V

- Note:
1. C1 & C2 (C3 & C4) are required and should be connected as close to the module pins as possible.
 2. Refer to Table 1 for C1 and C2 (C3 and C4) capacitor values. For certain applications, increased values for C2 and C4 and/or tantalum or low ESR electrolytic capacitors may also be used instead;
 3. When using configurations as shown in figure 3, we recommended to add an inductor (LDM) with a value of up to 10 μ H which helps reducing mutual interference;
 4. Converter cannot be used for hot swap and with output in parallel.

EMC RECOMMENDED CIRCUIT

Figure 4

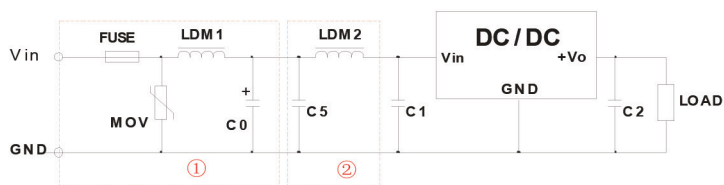

- Note:
1. Part ① in Fig. 4 shows EMS compliance filter and part ② filter for EMI compliance; depending on requirement both filters ① and ② can be used in series as shown.

Table 2

Recommended external circuit components	
FUSE	choose according to actual input current
MOV	S20K30
LDM1	82 μ H
C0	680 μ F/50 V
C1, C2	see Table 1
C5	4.7 μ F/50 V
LDM2	12 μ H

REVISION HISTORY

rev.	description	date
1.0	initial release	03/09/2020

The revision history provided is for informational purposes only and is believed to be accurate.



Headquarters
20050 SW 112th Ave.
Tualatin, OR 97062
800.275.4899

Fax 503.612.2383
cui.com
techsupport@cui.com

CUI offers a two (2) year limited warranty. Complete warranty information is listed on our website.

CUI reserves the right to make changes to the product at any time without notice. Information provided by CUI is believed to be accurate and reliable. However, no responsibility is assumed by CUI for its use, nor for any infringements of patents or other rights of third parties which may result from its use.

CUI products are not authorized or warranted for use as critical components in equipment that requires an extremely high level of reliability. A critical component is any component of a life support device or system whose failure to perform can be reasonably expected to cause the failure of the life support device or system, or to affect its safety or effectiveness.