

# UltraFlo®

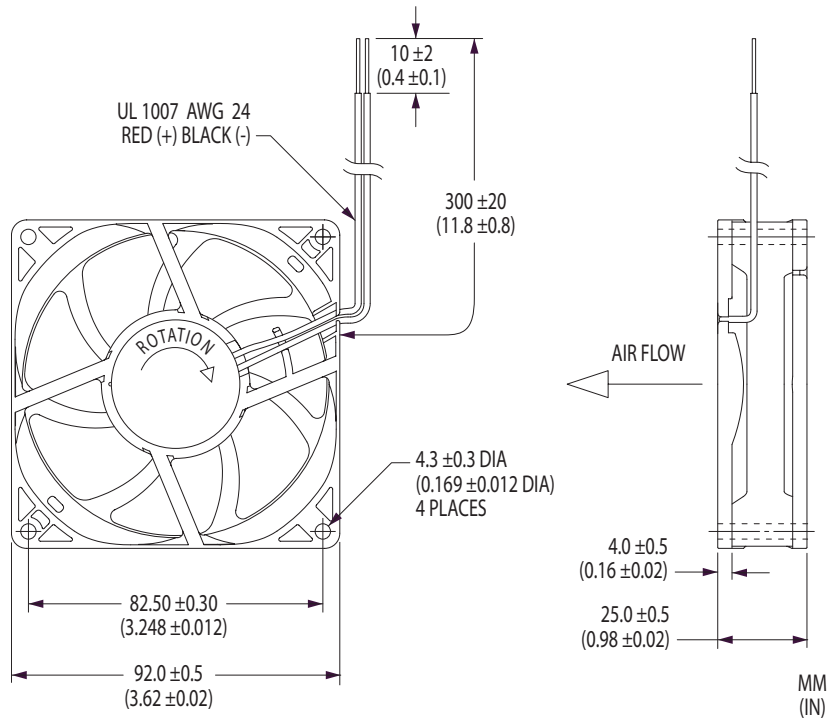

## U92T Series

- ✓ Durable, Magnetically Stabilized NBRX Sleeve Bearing Design
- ✓ Current-Limit Protection
- ✓ Optional Open-Collector Tachometer or Locked Rotor Alarm
- ✓ Plastic Housing and Impeller Rated V-0
- ✓ 12V and 24V Models



## 92 x 25mm Tube Axial Cooling Fans

Model	Air Flow (CFM)	Max. Static Pressure (inwg)	Operating Voltage		Operating Current (A)	Input Power (W)	Fan Speed (rpm)	Sound Pressure (dBA)	Operating Temp.		L10 Life† (hours)
			Nominal (V)	Range (V)					Min. (°C)	Max. (°C)	
U92T12MUA7-51	52	0.18	12	7.0-13.8	0.25	3.0	3100	32.0	-10	+70	45,000
U92T24MUA7-51	52	0.18	24	10.0-27.6	0.14	3.4	3100	32.0	-10	+70	45,000
U92T12MGA7-51	45	0.15	12	7.0-13.8	0.18	2.2	2700	29.0	-10	+70	—
U92T24MGA7-51	45	0.15	24	10.0-27.6	0.10	2.4	2700	29.0	-10	+70	—
U92T12MHA7-51	40	0.12	12	7.0-13.8	0.14	1.7	2400	25.0	-10	+70	—
U92T24MHA7-51	40	0.12	24	10.0-27.6	0.08	1.9	2400	25.0	-10	+70	—
U92T12MMA7-51	34	0.09	12	7.0-13.8	0.10	1.2	2050	19.5	-10	+70	—
U92T24MMA7-51	34	0.09	24	10.0-27.6	0.05	1.2	2050	19.5	-10	+70	—

Air flow, current, speed and sound pressure ratings are at nominal operating voltage and zero static pressure. Current and power ratings are average expected values under those conditions. † L10 bearing life expectancy at T<sub>A</sub> = +40°C. © UltraFlo is a registered trademark of Nidec Corporation.

### Recommended Standard Connectors

Connector Pitch	Manufacturer	Housing*	Contacts
1.50 mm	J.S.T.	ZHR- <i>n</i>	SHZ-002T-P0.5
2.00 mm	J.S.T.	PHR- <i>n</i>	SPH-002T-P0.5S
	Tyco/AMP	173977- <i>n</i>	Includes Contacts
2.50 mm	J.S.T.	EHR- <i>n</i>	SEH-001T-P0.6
	J.S.T.	XHP- <i>n</i>	SXH-001T-P0.6
	Tyco/AMP	171822- <i>n</i>	Includes Contacts
2.54 mm	Molex	2695	5159

\* The character "*n*" shown at the end of housing model names represents the number of contact positions available with that housing. ZHR-2, for example, identifies a housing with two contact positions.



All for dreams

Nidec America Corporation · phone 781-848-0970 · email fans@nidecamerica.com · www.nidecamerica.com

U92T Tube Axials

# UltraFlo

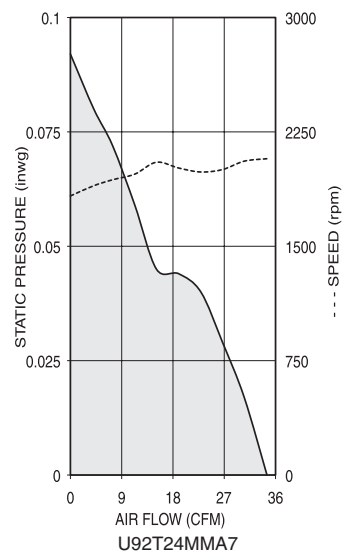
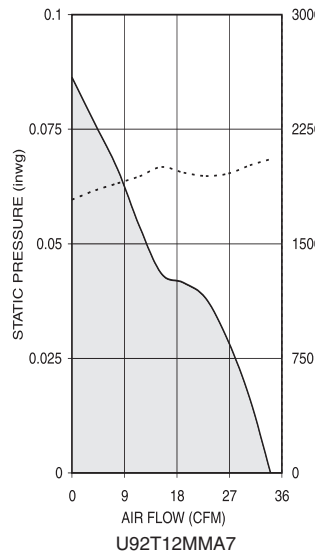
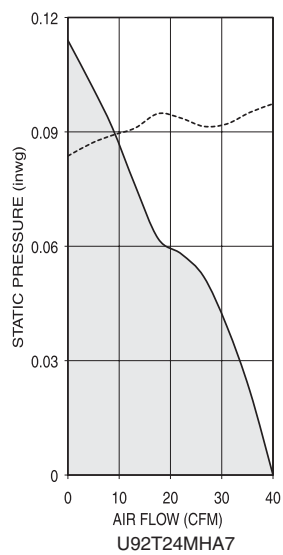
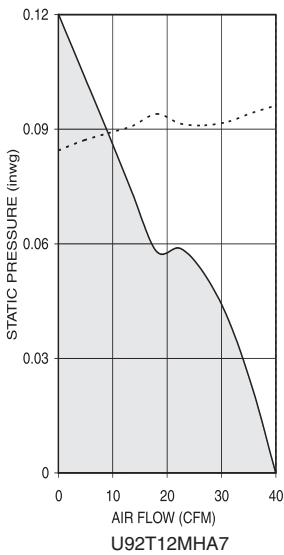
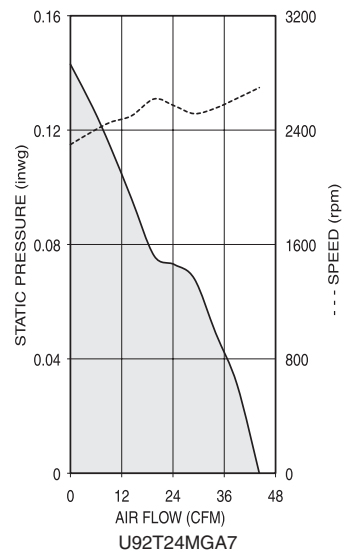
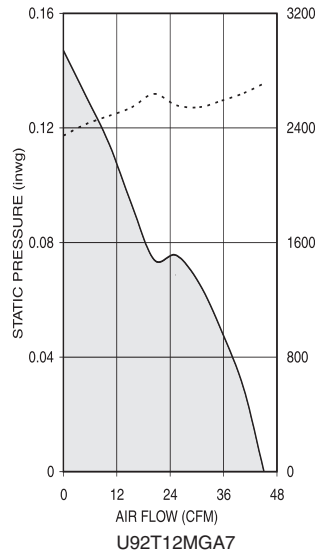
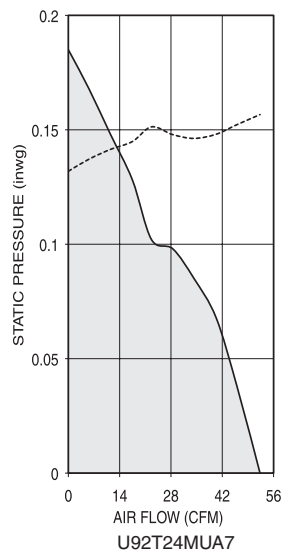
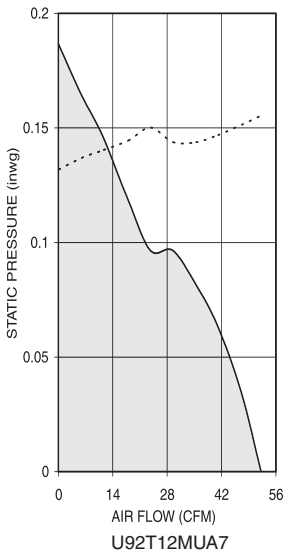

## OPEN-COLLECTOR TACHOMETER

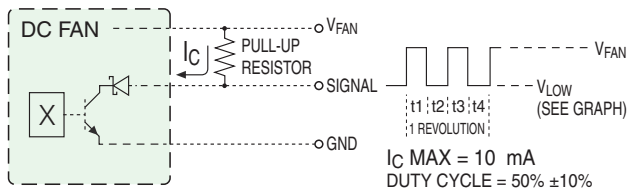

Option '-52'

## TYPICAL VALUES OF $V_{LOW}$ AS A FUNCTION OF $I_C$

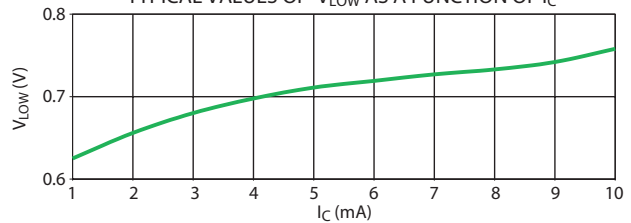

Option '-53'

## OPEN-COLLECTOR LOCKED ROTOR ALARM

