



RAYCHEM | RAYCHEM TXR

TE Internal #: 145697-000

Ruggedized, Backshell, .01 – .38 in [.2 – 9.5 mm] Cable Entry, Aluminum, Straight, Shell Size 10 / 11, RAYCHEM TXR

[View on TE.com >](#)

Connectors > Connector Accessories > Connector Backshells



Connector Backshell Product Style: **Ruggedized**

Connector Backshell Product Type: **Backshell**

Cable Entry Diameter: **.2 – 9.5 mm [.01 – .38 in]**

Primary Product Material: **Aluminum**

Body Orientation: **Straight**

### Features

#### Product Type Features

Termination Device Included	TR06AI
Connector Backshell Product Style	Ruggedized
Connector Backshell Product Type	Backshell
Termination Device Type	Side-Entry Tinel-Lock Ring, Tinel-Lock Adapter, Tinel-Lock Ring

#### Body Features

Primary Product Color	Olive Drab
Primary Product Material	Aluminum
Primary Product Plating Material	Cadmium (AMS-QQ-P-416, Type II, Class 3)

#### Housing Features

Body Orientation	Straight
Compatible With Connector Shape	Circular

#### Dimensions

Compatible Cable Diameter Range	4.8 – 7.6 mm [.188 – .3 in]
Product Length	26.8 mm [1.05 in]
Cable Entry Diameter	.2 – 9.5 mm [.01 – .38 in]

#### Usage Conditions

Salt Spray Resistance	500 Hr
-----------------------	--------



Operating Temperature Range -65 – 175 °C[-85 – 347 °F]

### Operation/Application

Compatible With Connector Shell Size 10, 11

### Industry Standards

Connector Detail Specification Number MS24266, MS27467, MS27468, MS27472, MS27473, MS27474, MS27479, MS27480, MS27481, MS27484, MS27497, MS27652, MS27653, MS27656, MS27661, MS27665

### Other

Connector Interface Specification MIL-DTL-38999 Series I, MIL-DTL-38999 Series I/Class E,P,T, MIL-DTL-38999 Series I /Class E,T, MIL-DTL-38999 Series II/Class E, P,T, MIL-DTL-38999 Series II/Class E,T, MIL-DTL-38999 Series II/Class T

TE Connector Interface Code 41

### Product Compliance

[For compliance documentation, visit the product page on TE.com>](#)

EU RoHS Directive 2011/65/EU Not Compliant

EU ELV Directive 2000/53/EC Not Compliant

China RoHS 2 Directive MIIT Order No 32, 2016 Restricted Materials Above Threshold

EU REACH Regulation (EC) No. 1907/2006 Current ECHA Candidate List: JUNE 2023 (235)

Candidate List Declared Against: JUNE 2023 (235)

SVHC > Threshold:

Cd (.28% in Component Part)

**Article Safe Usage Statements:**

Use personal protective equipment as required. Do not eat, drink or smoke when using this product. Recycle if possible and dispose of the article by following all applicable governmental regulations relevant to your geographic location.

Halogen Content Low Halogen - Br, Cl, F, I < 900 ppm per homogenous material. Also BFR/CFR/PVC Free

Solder Process Capability Not applicable for solder process capability

#### Product Compliance Disclaimer

This information is provided based on reasonable inquiry of our suppliers and represents our current actual knowledge based on the information they provided. This information is subject to change. The part numbers that TE has identified as EU RoHS compliant have a maximum concentration of 0.1% by weight in homogenous materials for lead, hexavalent chromium, mercury, PBB, PBDE, DBP, BBP, DEHP, DIBP, and 0.01% for cadmium, or qualify for an exemption to these limits as defined in the Annexes of Directive 2011/65/EU (RoHS2). Finished electrical and electronic equipment products will be CE marked as required by Directive 2011/65/EU. Components may not be CE marked. Additionally, the part numbers that TE has identified as EU ELV compliant have a maximum concentration of 0.1% by weight in homogenous materials for lead, hexavalent chromium, and mercury, and 0.01% for cadmium, or qualify for an exemption to these limits

as defined in the Annexes of Directive 2000/53/EC (ELV). Regarding the REACH Regulation, the information TE provides on SVHC in articles for this part number is based on the latest European Chemicals Agency (ECHA) 'Guidance on requirements for substances in articles' posted at this URL: <https://echa.europa.eu/guidance-documents/guidance-on-reach>

## Compatible Parts



TE Part # 173643-000  
RH-3960-1-TINEL-KIT-120V

## Also in the Series | RAYCHEM TXR



Connector Backshells(2277)

## Customers Also Bought

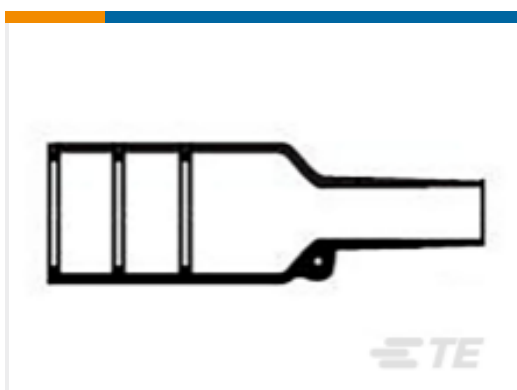

TE Part #878497-000  
Bulbous Heat Shrink Boots: Lipped, Straight

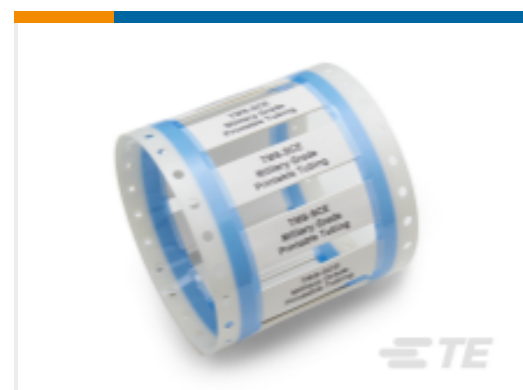

TE Part #0567590001  
TMS-SCE Military Grade Sleeves

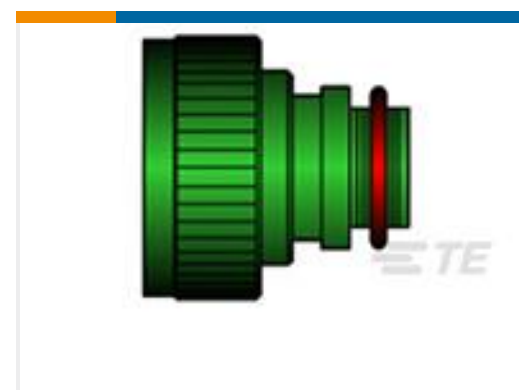

TE Part #121571-000  
TXR40AB00-1610AI

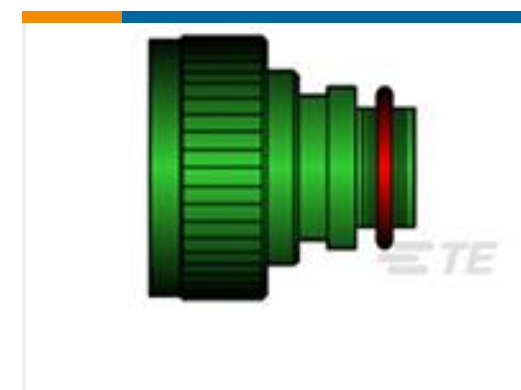

TE Part #293973-000  
TXR40AB00-1612AI

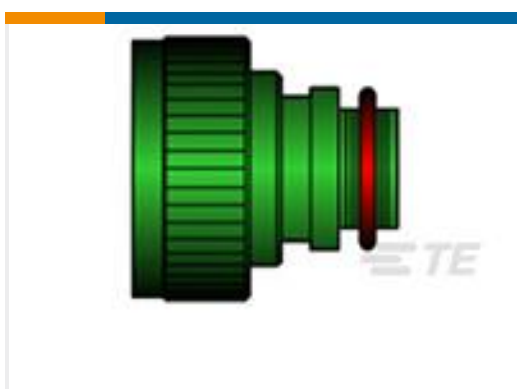

TE Part #820593-000  
TXR40AB00-2012AI

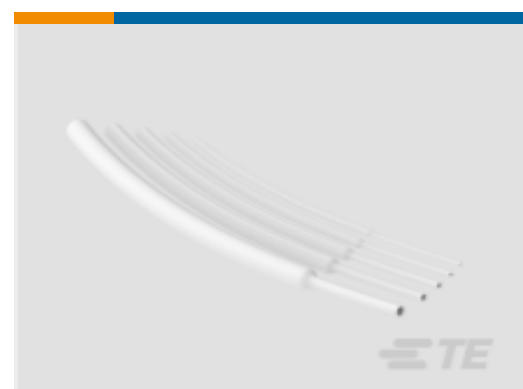

TE Part #NB19792001  
RNF-100-3/32-WH-STK

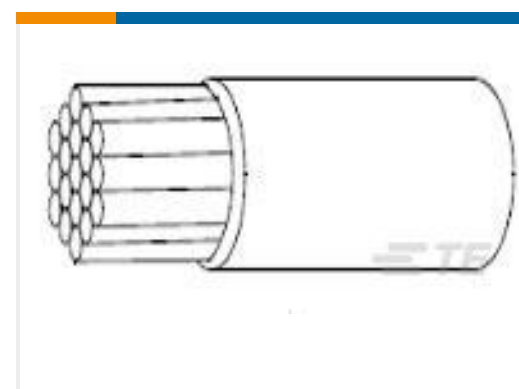

TE Part #CD60373001  
55A0111-26-8CK0001

## Documents



### Product Drawings

[TXR41AB00-1006AI](#)

English

---

### CAD Files

[3D PDF](#)

3D

**Customer View Model**

[ENG\\_CVM\\_CVM\\_145697-000\\_O.2d\\_dxf.zip](#)

English

**Customer View Model**

[ENG\\_CVM\\_CVM\\_145697-000\\_O.3d\\_igs.zip](#)

English

**Customer View Model**

[ENG\\_CVM\\_CVM\\_145697-000\\_O.3d\\_stp.zip](#)

English

By downloading the CAD file I accept and agree to the [Terms and Conditions](#) of use.

---

### Datasheets & Catalog Pages

[5-1654025-5\\_sec6\\_Adapters](#)

English

[Circular Backshells](#)

English

---

### Product Specifications

[General Information Package for Tinel-Lock Adapters](#)

English

[Braid termination using a Tinel Lock Ring installed using a resistance heater.](#)

French

[Braid termination using a Tinel Lock Ring installed using a resistance heater.](#)

English

[PERFORMANCE SPECIFICATION Tinel-Lock Rings, Heat Recoverable for Braid Termination](#)

English

[General Harness Repair Manual](#)

English

[ASSEMBLY GUIDE for Tinel -Lock Rings, Heat Recoverable for Braid Temination](#)

English

[Product Specification](#)

English