

TPS8269x High-Efficiency MicroSIP™ Step-Down Converter (Profile <1mm)

1 Features

- Total Solution Size 6.7 mm^2
- 95% Efficiency at 3MHz Operation
- 23 μA Quiescent Current
- High Duty-Cycle Operation
- *Best in Class* Load and Line Transient
- $\pm 2\%$ Total DC Voltage Accuracy
- Automatic PFM/PWM Mode Switching
- Low Ripple Light-Load PFM Mode
- Excellent AC Load Regulation
- Internal Soft Start, 200- μs Start-Up Time
- Integrated Active Power-Down Sequencing (Optional)
- Current Overload and Thermal Shutdown Protection
- Sub 1-mm Profile Solution

2 Applications

- Cell Phones, Smart-Phones
- Optical Data Modules
- Camera and Sensor Modules
- Wearable Devices
- LDO Replacement

3 Description

The TPS8269xSIP device is a complete 500mA / 800mA, DC/DC step-down power supply intended for low-power applications. Included in the package are the switching regulator, inductor and input/output capacitors. No additional components are required to finish the design. The TPS8269xSIP is based on a high-frequency synchronous step-down dc-dc converter optimized for battery-powered portable applications. The MicroSIP™ DC/DC converter operates at a regulated 3-MHz switching frequency and enters the power-save mode operation at light load currents to maintain high efficiency over the entire load current range. The PFM mode extends the battery life by reducing the quiescent current to 23 μA (typ) during light load operation. For noise-sensitive applications, the device has PWM spread spectrum capability providing a lower noise regulated output, as well as low noise at the input. These features, combined with high PSRR and AC load regulation performance, make this device suitable to replace a linear regulator to obtain better power conversion efficiency. The TPS8269xSIP is packaged in a compact (2.3mm x 2.9mm) and low profile (1.0mm) BGA package suitable for automated assembly by standard surface mount equipment.

Device Information

ORDER NUMBER	PACKAGE	BODY SIZE
TPS82692SIP	μSIP (8)	2,9mm x 2,3mm
TPS82693SIP	μSIP (8)	2,9mm x 2,3mm
TPS826951SIP	μSIP (8)	2,9mm x 2,3mm
TPS82697SIP	μSIP (8)	2,9mm x 2,3mm
TPS82698SIP	μSIP (8)	2,9mm x 2,3mm

4 Simplified Schematic

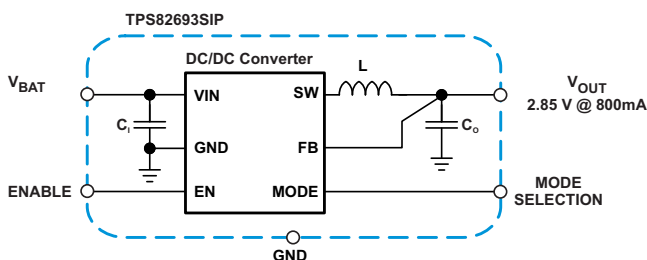

Efficiency vs Output Current

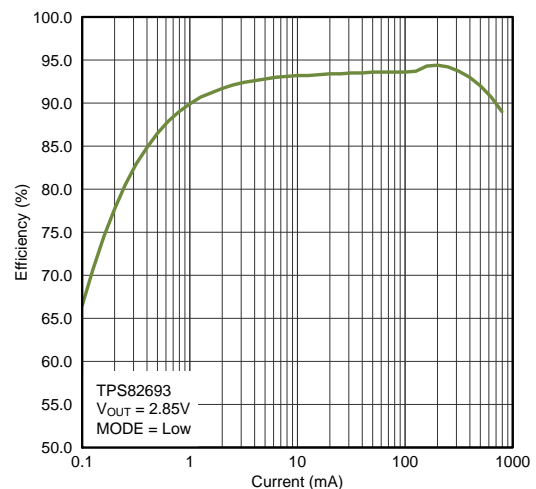

G000



Table of Contents

1 Features	1	10 Applications and Implementation	19
2 Applications	1	10.1 Application Information.....	19
3 Description	1	10.2 Typical Application	19
4 Simplified Schematic	1	11 Power Supply Recommendations	20
5 Revision History	2	12 Layout	21
6 Terminal Configuration and Functions	3	12.1 Layout Guidelines	21
7 Specifications	4	12.2 Layout Example	21
7.1 Absolute Maximum Ratings	4	12.3 Surface Mount Information	21
7.2 Handling Ratings.....	4	12.4 Thermal And Reliability Information	22
7.3 Recommended Operating Conditions.....	4	13 Device and Documentation Support	24
7.4 Thermal Information	5	13.1 Documentation Support	24
7.5 Electrical Characteristics.....	5	13.2 Related Links	24
7.6 Typical Characteristics.....	8	13.3 Trademarks	24
8 Parameter Measurement Information	13	13.4 Electrostatic Discharge Caution.....	24
9 Detailed Description	16	13.5 Glossary	24
9.1 Overview	16	14 Mechanical, Packaging, and Orderable Information	25
9.2 Functional Block Diagram	16	14.1 Package Summary.....	25
9.3 Feature Description.....	17	14.2 MicroSIP™	25
9.4 Device Functional Modes.....	18		

5 Revision History

NOTE: Page numbers for previous revisions may differ from page numbers in the current version.

Changes from Revision A (July 2013) to Revision B	Page
• Global format to new data sheet standard	1
• Changed TPS82692, TPS826951 devices to production status.	3
• Changed Ordering Information table to "Device Comparison" table with cross reference to the POA at end of document.	3
• Moved Abs Max Ratings, Handling Ratings, Rec Oper Conditions, Thermal Info, and Elec Characteristics tables to the Specifications section	4
• Deleted Regulated DC Output Voltage parameters to electrical characteristics table for device TPS82692	6
• Added efficiency graphs for device TPS82692	10

Changes from Original (March 2013) to Revision A	Page
• Added Regulated DC Output Voltage parameters to electrical characteristics table for device TPS82697	6
• Added Regulated DC Output Voltage parameters to electrical characteristics table for device TPS826951	6
• Added Regulated DC Output Voltage parameters to electrical characteristics table for device TPS82698	6
• Added Power-save mode ripple voltage to electrical characteristics table for devices TPS826951, TPS82697, TPS82698	7
• Added Start-up time to electrical characteristics table for devices TPS826951, TPS82697, TPS82698.....	7
• Added Efficiency vs Load Current Graph figure references to Table of Graphs.	8
• Added Transient Response Plots to Typical Characteristics for device TPS826951.....	13
• Added AC Load Transient Response Plots to Typical Characteristics for devices TPS826951, TPS82698.....	13

Table 1. Device Comparison⁽¹⁾

PART NUMBER	OUTPUT VOLTAGE	SPECIFIC FEATURE	STATUS
TPS82692	2.2V	800mA peak output current, spread spectrum frequency modulation	Production
TPS82693	2.85V	800mA peak output current, spread spectrum frequency modulation, output discharge	Production
TPS826951	2.5V	800mA peak output current	Production
TPS82697	2.8V	800mA peak output current	Production
TPS82698	3.0V	800mA peak output current, spread spectrum frequency modulation, output discharge	Production

(1) See the Package Option Addendum at the end of this document for [Orderable Information](#).

6 Terminal Configuration and Functions

8-Bump μ SIP Package

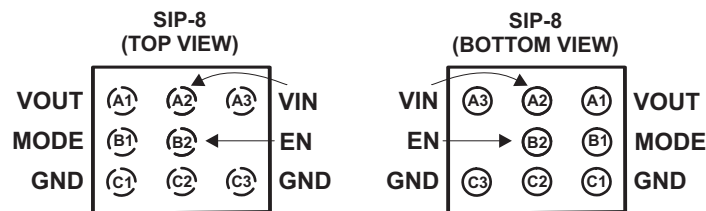
Table 2. Terminal Functions

TERMINAL		I/O	DESCRIPTION
NAME	NO.		
VOUT	A1	O	Power output terminal. Apply output load between this terminal and GND.
VIN	A2, A3	I	The VIN terminals supply current to the TPS8269xSIP's internal regulator.
EN	B2	I	This is the enable terminal of the device. Connecting this terminal to ground forces the converter into shutdown mode. Pulling this terminal to V_{IN} enables the device. This terminal must not be left floating and must be terminated.
MODE	B1	I	This is the mode selection terminal of the device. This terminal must not be left floating and must be terminated. MODE = LOW: The device is operating in regulated frequency pulse width modulation mode (PWM) at high-load currents and in pulse frequency modulation mode (PFM) at light load currents. MODE = HIGH: Low-noise mode enabled, regulated frequency PWM operation forced.
GND	C1, C2, C3	–	Ground terminal.

7 Specifications

7.1 Absolute Maximum Ratings

over operating free-air temperature range (unless otherwise noted)⁽¹⁾

		MIN	MAX	UNIT
Input Voltage	Voltage at VIN ⁽²⁾⁽³⁾ , SW ⁽³⁾	-0.3	6	V
	Voltage at VOUT ⁽³⁾	-0.3	3.6	V
	Voltage at EN, MODE ⁽³⁾	-0.3	V _{IN} + 0.3	V
Peak output current, I _O ⁽⁴⁾	TPS82692, TPS82693, TPS826951, TPS82697, TPS82698		800 ⁽⁴⁾	mA
Power dissipation		Internally limited		
Operating temperature range, T _A ⁽⁵⁾		-40	85	°C
Maximum internal operating temperature, T _{INT(max)}			125	°C

- (1) Stresses beyond those listed under *absolute maximum ratings* may cause permanent damage to the device. These are stress ratings only and functional operation of the device at these or any other conditions beyond those indicated under *recommended operating conditions* is not implied. Exposure to absolute-maximum-rated conditions for extended periods may affect device reliability.
- (2) Operation above 4.8V input voltage is not recommended over an extended period of time.
- (3) All voltage values are with respect to network ground terminal.
- (4) Limit to 50% Duty Cycle over Lifetime.
- (5) In applications where high power dissipation and/or poor package thermal resistance is present, the maximum ambient temperature may have to be derated. Maximum ambient temperature (T_{A(max)}) is dependent on the maximum operating junction temperature (T_{J(max)}), the maximum power dissipation of the device in the application (P_{D(max)}), and the junction-to-ambient thermal resistance of the part/package in the application (θ_{JA}), as given by the following equation: T_{A(max)} = T_{J(max)} - (θ_{JA} × P_{D(max)}). To achieve optimum performance, it is recommended to operate the device with a maximum junction temperature of 105°C.

7.2 Handling Ratings

		MIN	MAX	UNIT
T _{stg}	Storage temperature range	-55	125	°C
ESD	Human body model (HBM)		2	kV
	Charged device model (CDM)		1	kV

7.3 Recommended Operating Conditions

over operating free-air temperature range (unless otherwise noted)

		MIN	NOM	MAX	UNIT
V _{IN}	Input voltage range	2.3		4.8 ⁽¹⁾	V
I _O	Output current range			800	mA
	Additional output capacitance (PFM/PWM)		0	4	µF
	Additional output capacitance (PWM)		0	7	µF
T _A	Ambient temperature	-40		+85	°C
T _J	Operating junction temperature	-40		+125	°C

- (1) Operation above 4.8V input voltage is not recommended over an extended period of time.

7.4 Thermal Information

THERMAL METRIC ⁽¹⁾		TPS82693/4/51/7/8/9	UNIT
		SIP (8-TERMINALS)	
θ_{JA}	Junction-to-ambient thermal resistance	83	°C/W
θ_{JCTop}	Junction-to-case (top) thermal resistance	53	
θ_{JB}	Junction-to-board thermal resistance	-	
Ψ_{JT}	Junction-to-top characterization parameter	-	
Ψ_{JB}	Junction-to-board characterization parameter	-	
θ_{JCbot}	Junction-to-case (bottom) thermal resistance	-	

(1) For more information about traditional and new thermal metrics, see the *IC Package Thermal Metrics* application report, [SPRA953](#).

7.5 Electrical Characteristics

Minimum and maximum values are at $V_{IN} = 2.3V$ to $5.5V$, $V_{OUT} = 2.85V$, $EN = 1.8V$, AUTO mode and $T_A = -40^{\circ}C$ to $85^{\circ}C$; Circuit of Parameter Measurement Information section (unless otherwise noted). Typical values are at $V_{IN} = 3.6V$, $V_{OUT} = 2.85V$, $EN = 1.8V$, AUTO mode and $T_A = 25^{\circ}C$ (unless otherwise noted).

PARAMETER		TEST CONDITIONS		MIN	TYP	MAX	UNIT	
SUPPLY CURRENT								
I_Q	Operating quiescent current	TPS8269x	$I_O = 0mA$. Device not switching		23	50	μA	
		TPS8269x	$I_O = 0mA$, PWM mode		3.5		mA	
$I_{(SD)}$	Shutdown current	TPS8269x	$EN = GND$		0.2	7	μA	
UVLO	Undervoltage lockout threshold	TPS8269x			2.05	2.1	V	
Protection								
	Thermal Shutdown	TPS8269x			140		°C	
	Thermal Shutdown hysteresis	TPS8269x			10		°C	
I_{LIM}	Peak Output Current Limit	TPS8269x			1000		mA	
I_{sc}	Short Circuit Output Current Limit	TPS8269x			15		mA	
ENABLE, MODE								
V_{IH}	High-level input voltage	TPS8269x		1			V	
V_{IL}	Low-level input voltage					0.4		V
I_{ikg}	Input leakage current		Input connected to GND or VIN		0.01	1.5		μA
OSCILLATOR								
f_{SW}	Oscillator frequency	TPS8269x	$I_O = 0mA$, PWM mode. $T_A = 25^{\circ}C$	2.7	3	3.3	MHz	

Electrical Characteristics (continued)

Minimum and maximum values are at $V_{IN} = 2.3V$ to $5.5V$, $V_{OUT} = 2.85V$, $EN = 1.8V$, AUTO mode and $T_A = -40^{\circ}C$ to $85^{\circ}C$; Circuit of Parameter Measurement Information section (unless otherwise noted). Typical values are at $V_{IN} = 3.6V$, $V_{OUT} = 2.85V$, $EN = 1.8V$, AUTO mode and $T_A = 25^{\circ}C$ (unless otherwise noted).

PARAMETER		TEST CONDITIONS	MIN	TYP	MAX	UNIT	
OUTPUT							
V_{OUT}	Regulated DC output voltage	TPS82693 TPS82697	$3.15V \leq V_{IN} \leq 4.8V$, $0mA \leq I_O \leq 500mA$ PFM/PWM operation	$0.98 \times V_{NOM}$	V_{NOM}	$1.03 \times V_{NOM}$	V
			$3.25V \leq V_{IN} \leq 4.8V$, $500mA \leq I_O \leq 800mA$ PFM/PWM operation	$0.98 \times V_{NOM}$	V_{NOM}	$1.03 \times V_{NOM}$	V
			$3.15V \leq V_{IN} \leq 5.5V$, $0mA \leq I_O \leq 500mA$ PFM/PWM operation	$0.98 \times V_{NOM}$	V_{NOM}	$1.04 \times V_{NOM}$	V
			$3.25V \leq V_{IN} \leq 5.5V$, $500mA \leq I_O \leq 800mA$ PFM/PWM operation	$0.98 \times V_{NOM}$	V_{NOM}	$1.04 \times V_{NOM}$	V
			$3.15V \leq V_{IN} \leq 4.8V$, $0mA \leq I_O \leq 500mA$ PWM operation	$0.98 \times V_{NOM}$	V_{NOM}	$1.02 \times V_{NOM}$	V
			$3.25V \leq V_{IN} \leq 4.8V$, $500mA \leq I_O \leq 800mA$ PWM operation	$0.98 \times V_{NOM}$	V_{NOM}	$1.02 \times V_{NOM}$	V
		TPS826951	$2.9V \leq V_{IN} \leq 4.8V$, $0mA \leq I_O \leq 500mA$ PFM/PWM operation	$0.98 \times V_{NOM}$	V_{NOM}	$1.03 \times V_{NOM}$	V
			$3.15V \leq V_{IN} \leq 4.8V$, $500mA \leq I_O \leq 800mA$ PFM/PWM operation	$0.98 \times V_{NOM}$	V_{NOM}	$1.03 \times V_{NOM}$	V
			$2.9V \leq V_{IN} \leq 5.5V$, $0mA \leq I_O \leq 500mA$ PFM/PWM operation	$0.98 \times V_{NOM}$	V_{NOM}	$1.04 \times V_{NOM}$	V
			$3.15V \leq V_{IN} \leq 5.5V$, $500mA \leq I_O \leq 800mA$ PFM/PWM operation	$0.98 \times V_{NOM}$	V_{NOM}	$1.04 \times V_{NOM}$	V
			$2.9V \leq V_{IN} \leq 4.8V$, $0mA \leq I_O \leq 500mA$ PWM operation	$0.98 \times V_{NOM}$	V_{NOM}	$1.02 \times V_{NOM}$	V
			$3.15V \leq V_{IN} \leq 4.8V$, $500mA \leq I_O \leq 800mA$ PWM operation	$0.98 \times V_{NOM}$	V_{NOM}	$1.02 \times V_{NOM}$	V
		TPS82698	$3.3V \leq V_{IN} \leq 4.8V$, $0mA \leq I_O \leq 500mA$ PFM/PWM operation	$0.98 \times V_{NOM}$	V_{NOM}	$1.03 \times V_{NOM}$	V
			$3.45V \leq V_{IN} \leq 4.8V$, $500mA \leq I_O \leq 800mA$ PFM/PWM operation	$0.98 \times V_{NOM}$	V_{NOM}	$1.03 \times V_{NOM}$	V
			$3.3V \leq V_{IN} \leq 5.5V$, $0mA \leq I_O \leq 500mA$ PFM/PWM operation	$0.98 \times V_{NOM}$	V_{NOM}	$1.04 \times V_{NOM}$	V
			$3.45V \leq V_{IN} \leq 5.5V$, $500mA \leq I_O \leq 800mA$ PFM/PWM operation	$0.98 \times V_{NOM}$	V_{NOM}	$1.04 \times V_{NOM}$	V
			$3.3V \leq V_{IN} \leq 4.8V$, $0mA \leq I_O \leq 500mA$ PWM operation	$0.98 \times V_{NOM}$	V_{NOM}	$1.02 \times V_{NOM}$	V
			$3.45V \leq V_{IN} \leq 4.8V$, $500mA \leq I_O \leq 800mA$ PWM operation	$0.98 \times V_{NOM}$	V_{NOM}	$1.02 \times V_{NOM}$	V
	TPS82692	$2.5V \leq V_{IN} \leq 4.8V$, $0mA \leq I_O \leq 500mA$ PFM/PWM operation	$0.98 \times V_{NOM}$	V_{NOM}	$1.03 \times V_{NOM}$	V	
		$2.7V \leq V_{IN} \leq 4.8V$, $500mA \leq I_O \leq 800mA$ PFM/PWM operation	$0.98 \times V_{NOM}$	V_{NOM}	$1.03 \times V_{NOM}$	V	
		$2.5V \leq V_{IN} \leq 5.5V$, $0mA \leq I_O \leq 500mA$ PFM/PWM operation	$0.98 \times V_{NOM}$	V_{NOM}	$1.04 \times V_{NOM}$	V	
		$2.7V \leq V_{IN} \leq 5.5V$, $500mA \leq I_O \leq 800mA$ PFM/PWM operation	$0.98 \times V_{NOM}$	V_{NOM}	$1.04 \times V_{NOM}$	V	
		$2.5V \leq V_{IN} \leq 4.8V$, $0mA \leq I_O \leq 500mA$ PWM operation	$0.98 \times V_{NOM}$	V_{NOM}	$1.02 \times V_{NOM}$	V	
		$2.7V \leq V_{IN} \leq 4.8V$, $500mA \leq I_O \leq 800mA$ PWM operation	$0.98 \times V_{NOM}$	V_{NOM}	$1.02 \times V_{NOM}$	V	
	Line regulation		$V_{IN} = V_O + 0.5V$ (min $3.15V$) to $5.5V$ $I_O = 200mA$		0.18		%/V
	Load regulation		$I_O = 0mA$ to $800mA$		-0.0002		%/mA
	Feedback input resistance	TPS8269x			480		k Ω

Electrical Characteristics (continued)

Minimum and maximum values are at $V_{IN} = 2.3V$ to $5.5V$, $V_{OUT} = 2.85V$, $EN = 1.8V$, AUTO mode and $T_A = -40^{\circ}C$ to $85^{\circ}C$; Circuit of Parameter Measurement Information section (unless otherwise noted). Typical values are at $V_{IN} = 3.6V$, $V_{OUT} = 2.85V$, $EN = 1.8V$, AUTO mode and $T_A = 25^{\circ}C$ (unless otherwise noted).

PARAMETER		TEST CONDITIONS	MIN	TYP	MAX	UNIT	
ΔV_O	Power-save mode ripple voltage	TPS82693 TPS826951 TPS82697	$I_O = 1mA$ $C_O = 4.7\mu F$ X5R 6.3V 0402		30		mV _{PP}
		TPS82698	$I_O = 1mA$ $C_O = 4.7\mu F$ X5R 6.3V 0402		65		mV _{PP}
			$I_O = 1mA$ $C_O = 10\mu F$ X5R 6.3V 0603		25		mV _{PP}
		TPS82692	$I_O = 1mA$ $C_O = 10\mu F$ X5R 6.3V 0603		22		mV _{PP}
r_{DIS}	Discharge resistor for power-down sequence			120		Ω	
	Start-up time	TPS82693 TPS826951 TPS82698 TPS82697	$I_O = 0mA$, Time from active EN to V_O		200		μs
		TPS82692	$I_O = 0mA$, Time from active EN to V_O		160		μs

7.6 Typical Characteristics

Table 3. Table Of Graphs

			FIGURE
η	Efficiency	vs Load current (TPS82699 $V_{OUT} = 3.2V$)	Figure 1, Figure 2, Figure 3
		vs Load current (TPS82693 $V_{OUT} = 2.85V$)	Figure 4, Figure 5, Figure 6
		vs Load current (TPS82697 $V_{OUT} = 2.8V$)	Figure 7, Figure 8
		vs Load current (TPS826951 $V_{OUT} = 2.5V$)	Figure 9, Figure 10
		vs Load current (TPS82698 $V_{OUT} = 3.0V$)	Figure 11, Figure 12
		vs Input Voltage (TPS82699 $V_{OUT} = 3.2V$)	Figure 15
		vs Input Voltage (TPS82692 $V_{OUT} = 2.2V$)	Figure 41, Figure 42
	Peak-to-peak output ripple voltage	vs Load current (TPS82699 $V_{OUT} = 3.2V$)	Figure 16, Figure 17
V_O	DC output voltage	vs Load Current (TPS82699 $V_{OUT} = 3.2V$)	Figure 18
		vs Load Current (TPS82693 $V_{OUT} = 2.85V$)	Figure 19, Figure 20
	Load transient response	TPS82699 $V_{OUT} = 3.2V$	Figure 28, Figure 29, Figure 30
		TPS826951 $V_{OUT} = 2.5V$	Figure 31, Figure 32
	AC load transient response	TPS82699 $V_{OUT} = 3.2V$	Figure 33, Figure 34, Figure 35, Figure 36
		TPS826951 $V_{OUT} = 2.5V$	Figure 37, Figure 38, Figure 39, Figure 40
		TPS82698 $V_{OUT} = 3.0V$	Figure 41, Figure 42, Figure 43
	PFM/PWM boundaries	vs Input voltage (TPS82699 $V_{OUT} = 3.2V$)	Figure 21
I_Q	Quiescent current	vs Input voltage	Figure 22
f_s	PWM switching frequency	vs Input voltage (TPS82699 $V_{OUT} = 3.2V$)	Figure 23
	Start-up	(TPS82699 $V_{OUT} = 3.2V$)	Figure 24, Figure 25
	Shut-Down		Figure 26

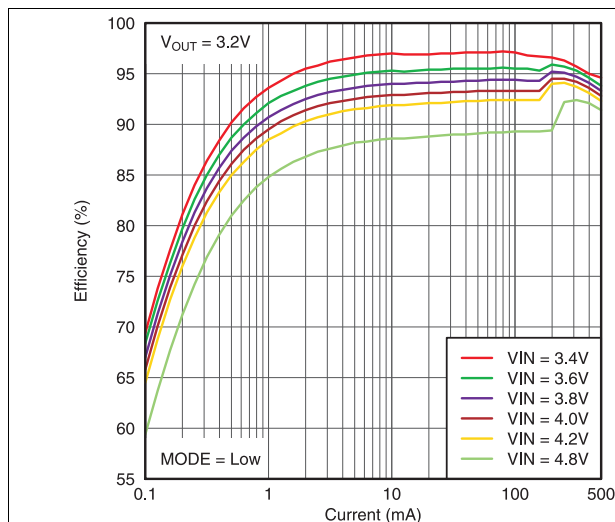

Figure 1. TPS82699 Efficiency vs Load Current

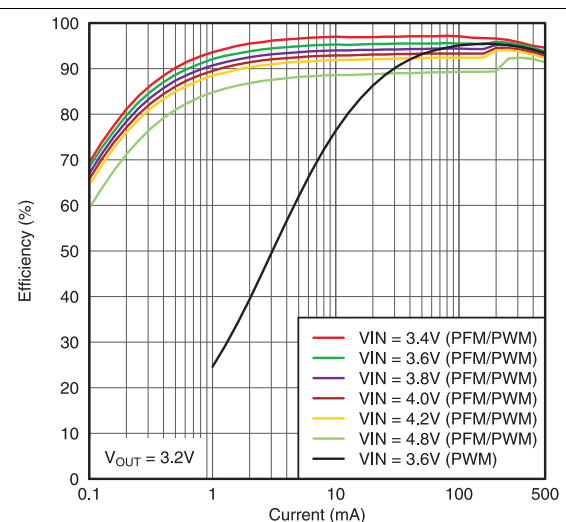

Figure 2. TPS82699 Efficiency vs Load Current

Typical Characteristics (continued)

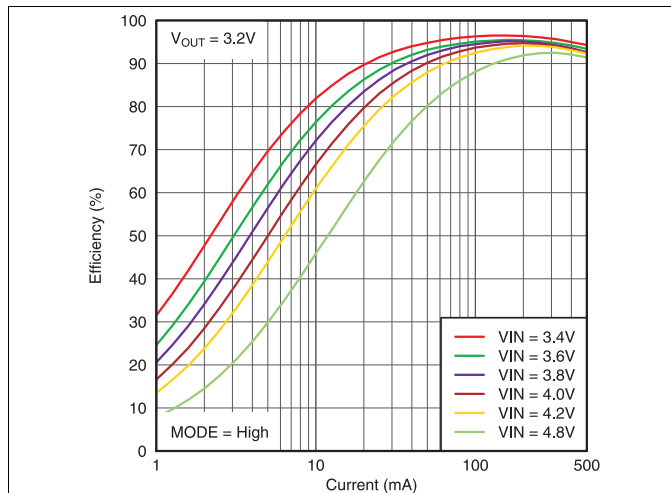

Figure 3. TPS82699 Efficiency vs Load Current

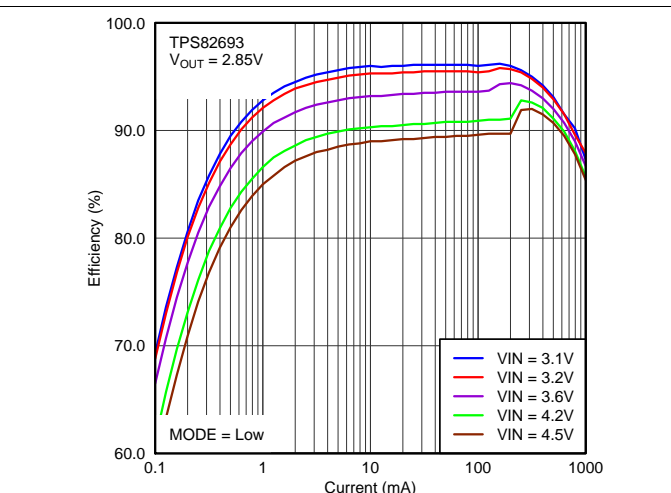

Figure 4. TPS82693 Efficiency vs Load Current

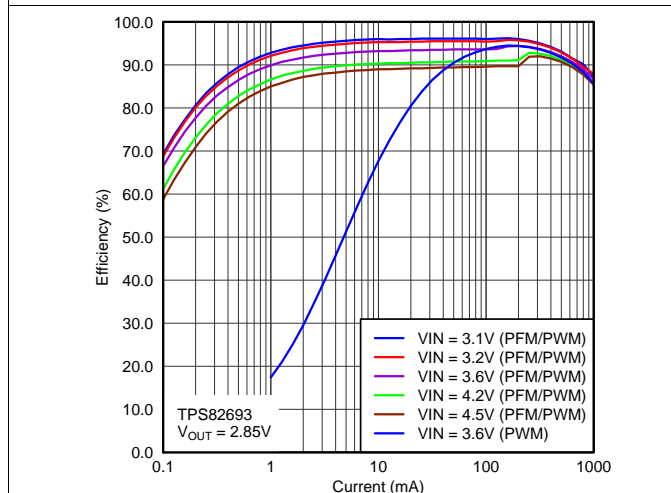

Figure 5. TPS82693 Efficiency vs Load Current

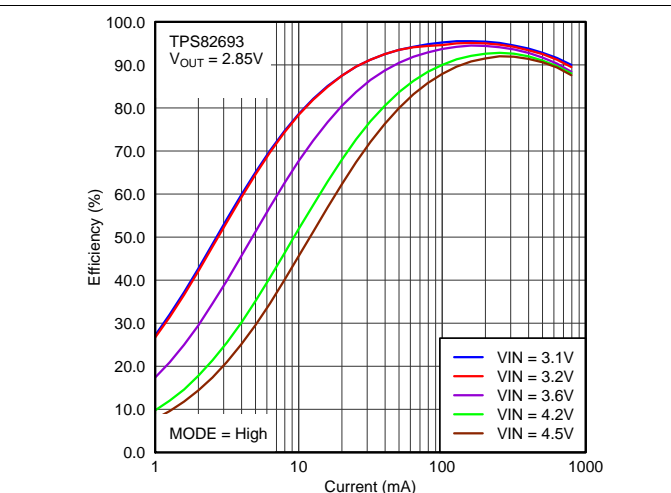

Figure 6. TPS82693 Efficiency vs Load Current

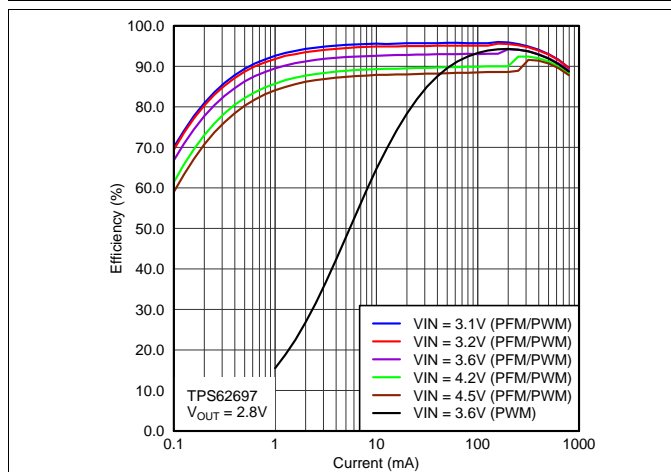

Figure 7. Efficiency vs Load Current Forced PWM Operation For Device TPS82697

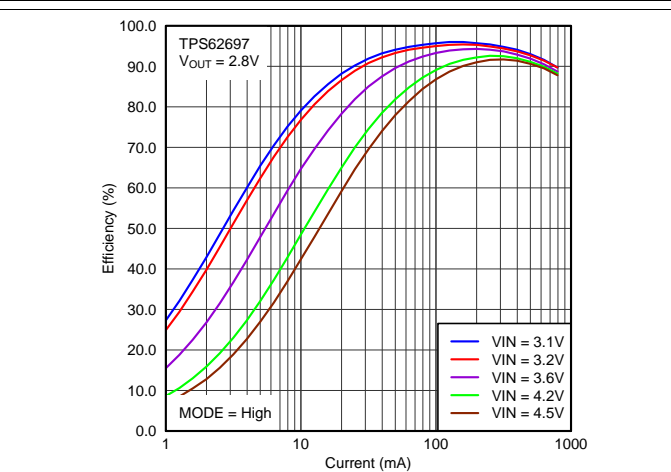

Figure 8. Efficiency vs Load Current Forced PWM Operation For Device TPS82697

Typical Characteristics (continued)

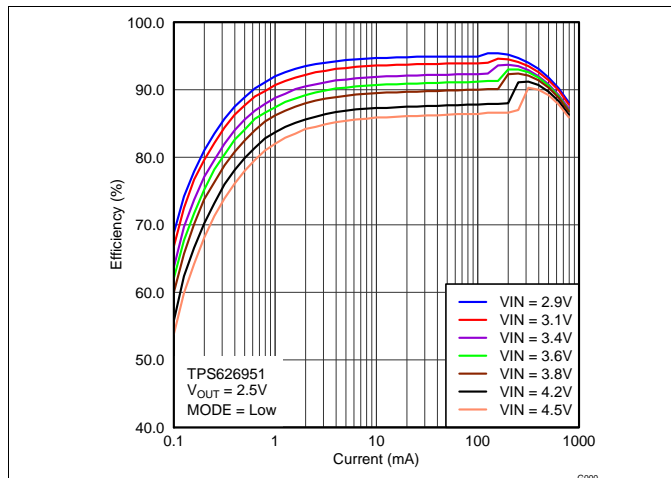

Figure 9. Efficiency vs Load Current PFM/PWM Operation For Device TPS826951

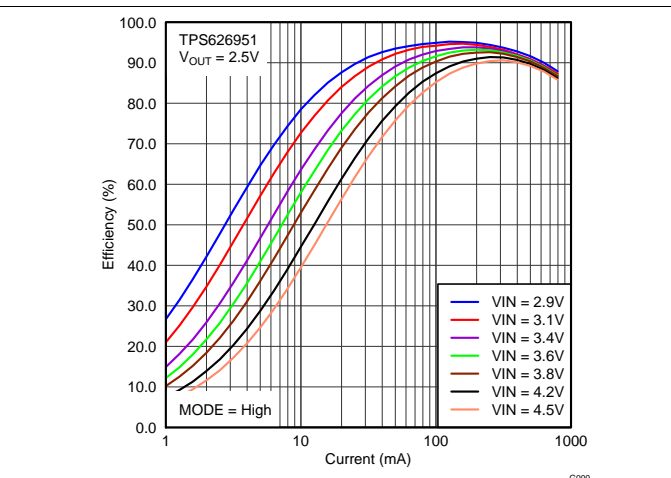

Figure 10. Efficiency vs Load Current Forced PWM Operation For Device TPS826951

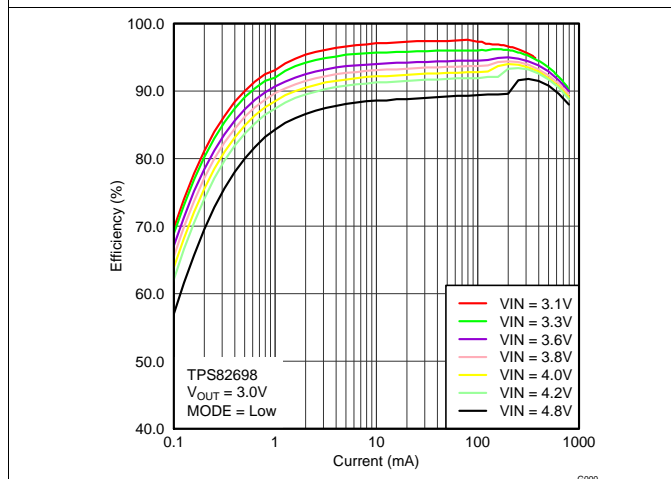

Figure 11. Efficiency vs Load Current PFM/PWM Operation For Device TPS82698

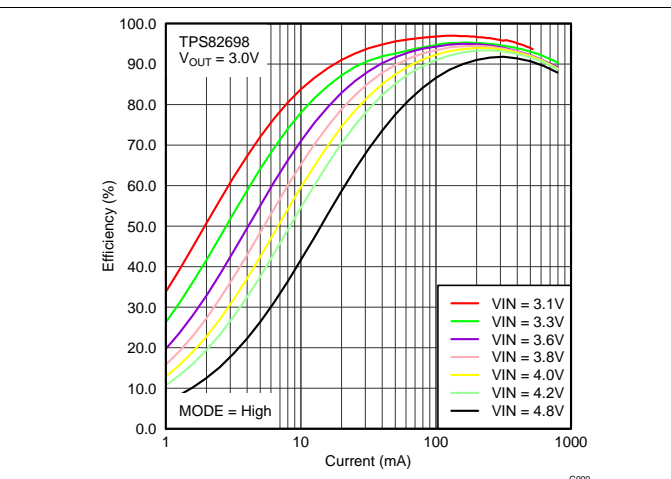

Figure 12. Efficiency vs Load Current Forced PWM Operation For Device TPS82698

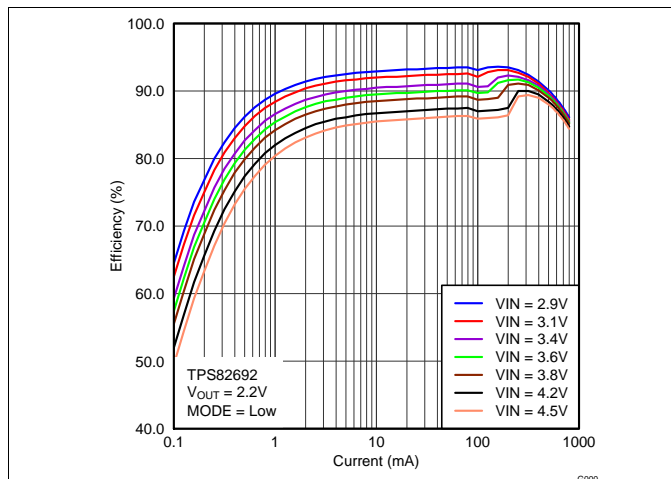

Figure 13. Efficiency vs Load Current PFM/PWM Operation For Device TPS82692

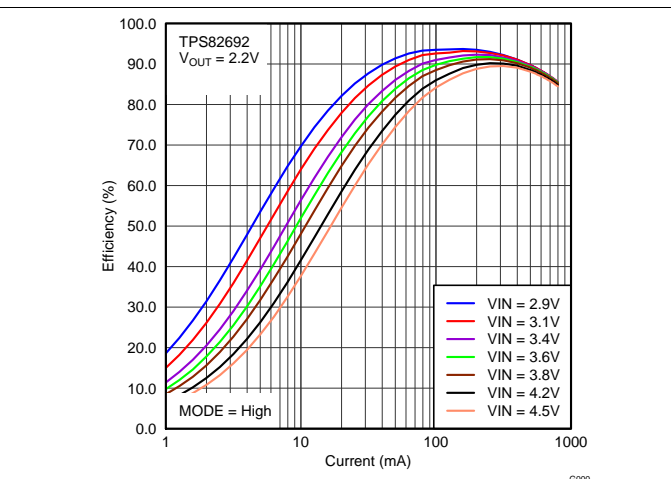

Figure 14. Efficiency vs Load Current PWM Operation For Device TPS82692

Typical Characteristics (continued)

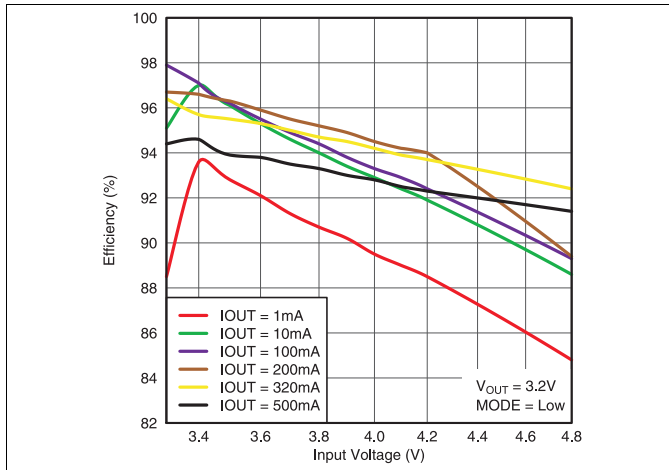

Figure 15. TPS82699 Efficiency vs Input Voltage

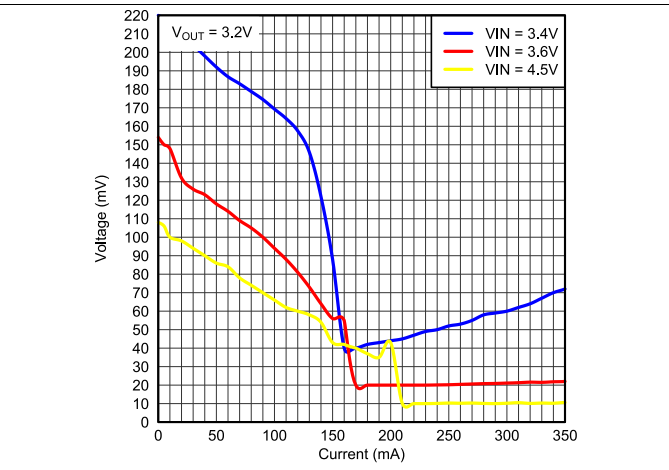

Figure 16. TPS82699 Peak-To-Peak Output Ripple Voltage vs Load Current

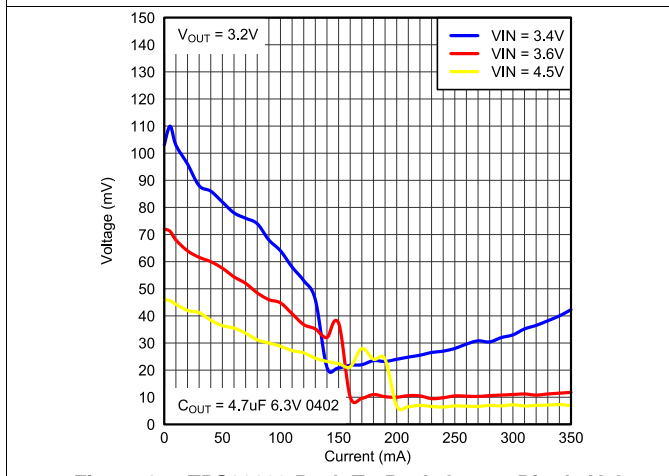

Figure 17. TPS82699 Peak-To-Peak Output Ripple Voltage vs Load Current

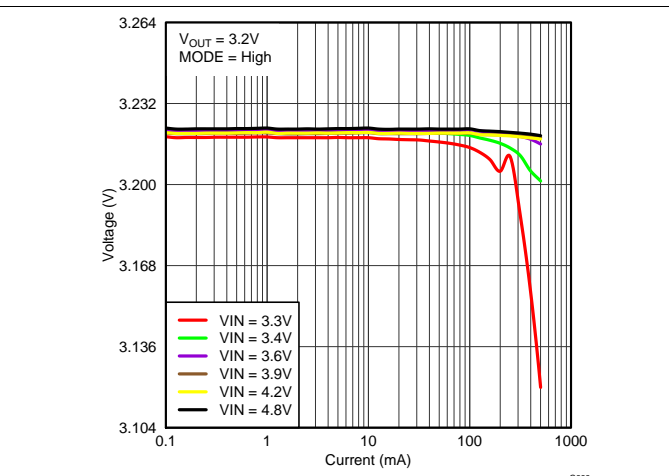

Figure 18. TPS82699 DC Output Voltage vs Load Current

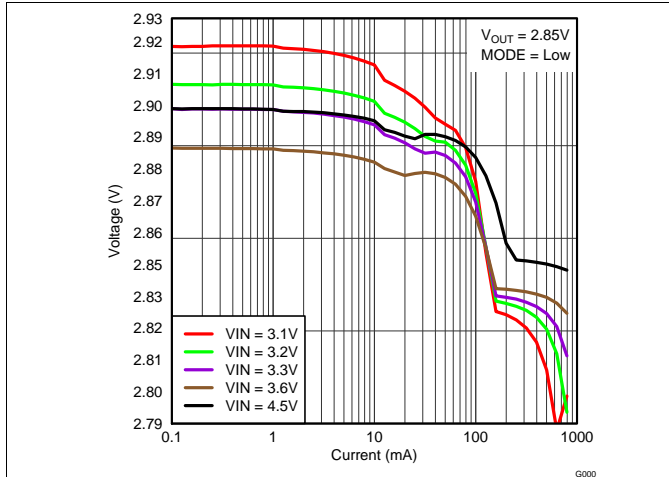

Figure 19. TPS82693 DC Output Voltage vs Load Current

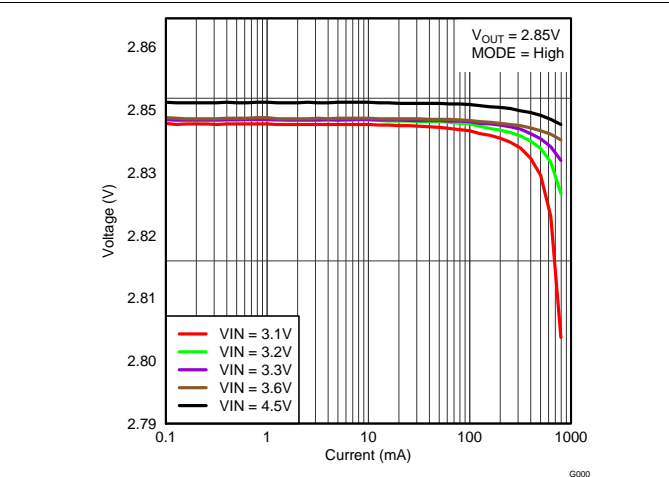

Figure 20. TPS82693dc Output Voltage vs Load Current

Typical Characteristics (continued)

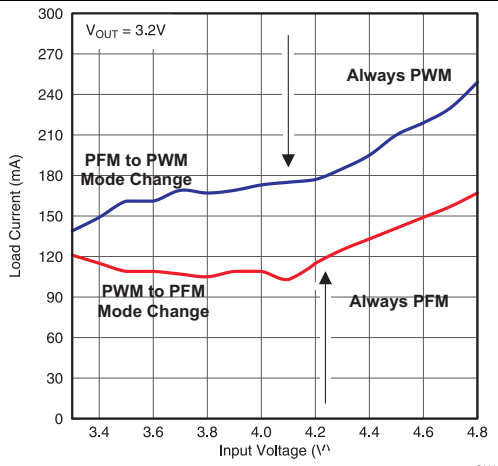

Figure 21. TPS82699 PFM/PWM Boundaries

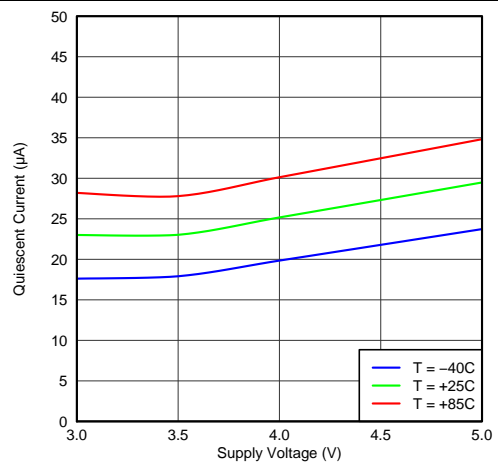

Figure 22. Quiescent Current vs Input Voltage

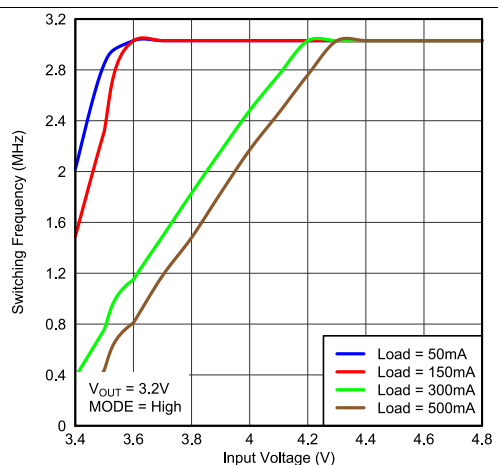

Figure 23. TPS82699 PWM Switching Frequency vs Input Voltage

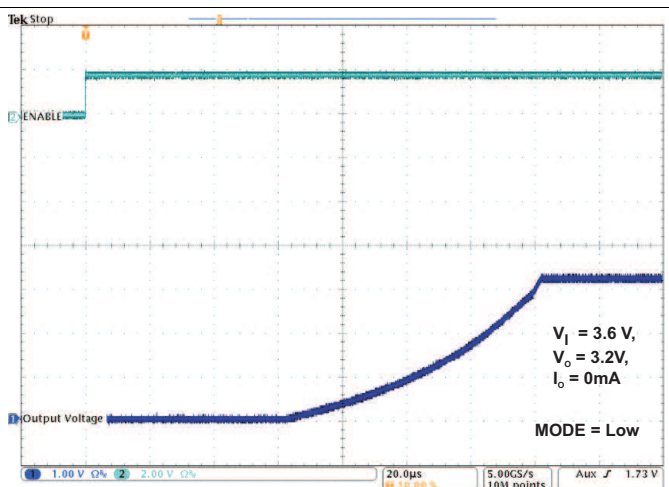

Figure 24. TPS82699 Start-Up

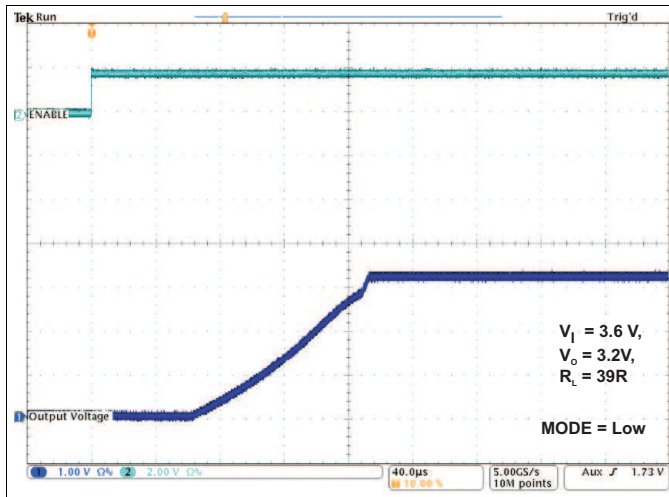

Figure 25. TPS82699 Start-Up

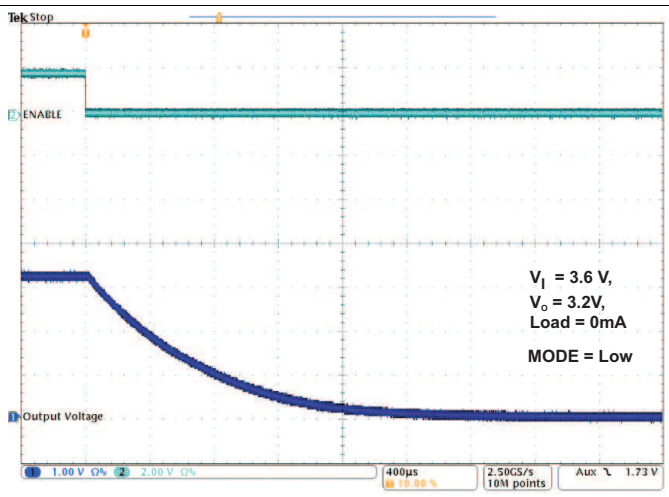

Figure 26. TPS82699 Shut-Down

8 Parameter Measurement Information

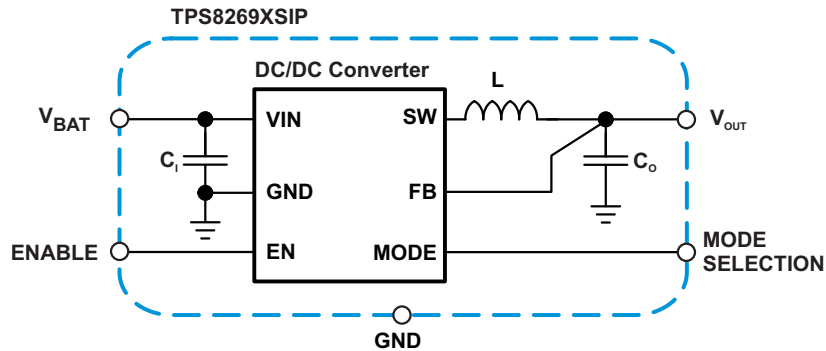

Figure 27. Circuit

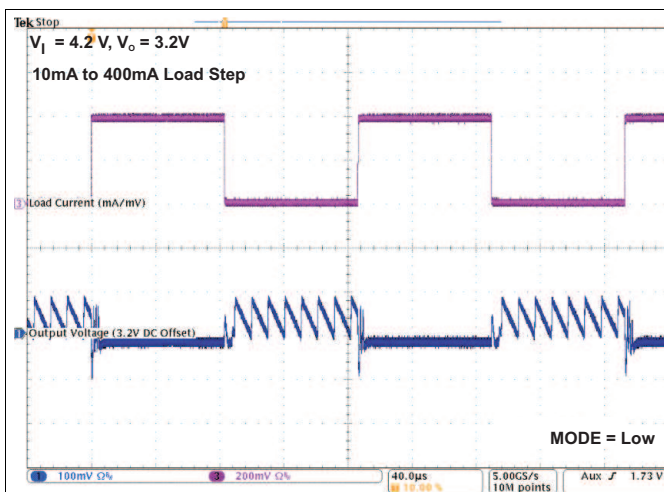

Figure 28. TPS8269 Load Transient Response In PFM/PWM Operation

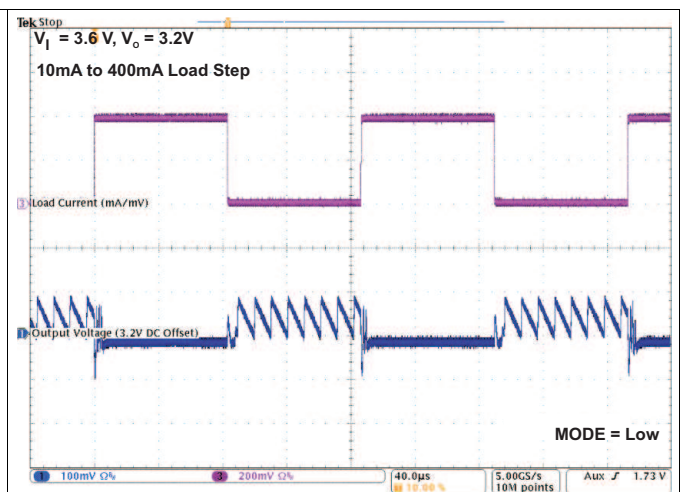

Figure 29. TPS82699 Load Transient Response In PFM/PWM Operation

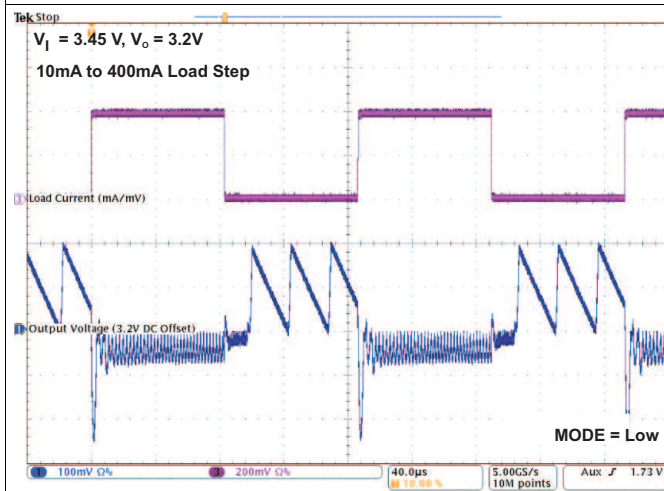

Figure 30. TPS82699 Load Transient Response In PFM/PWM Operation

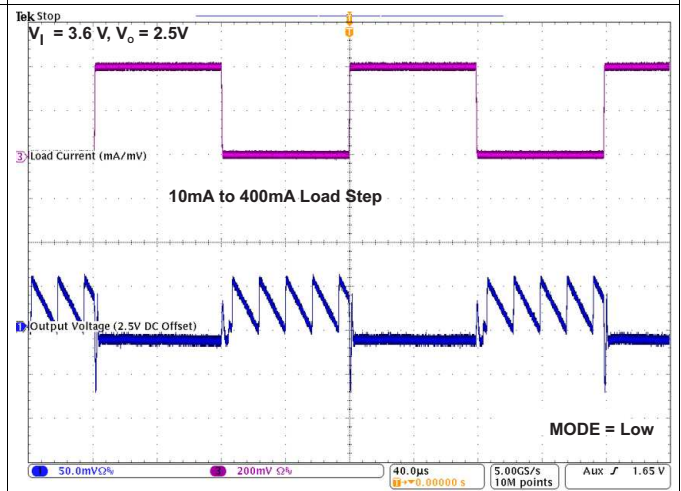

Figure 31. TPS826951 Load Transient Response In PFM/PWM Operation

Parameter Measurement Information (continued)

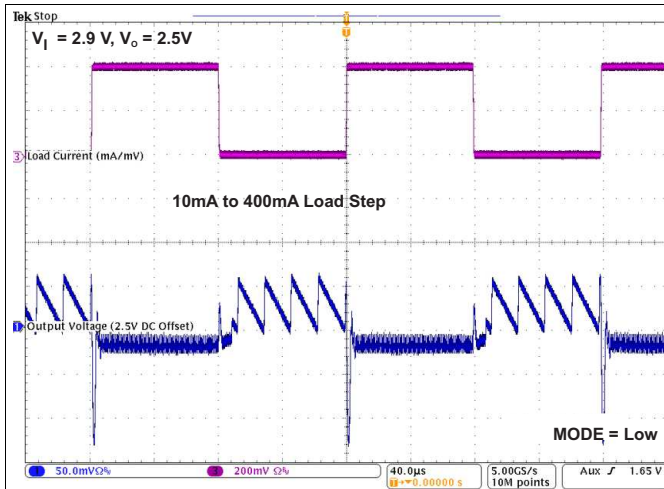

Figure 32. TPS826951 Load Transient Response In PFM/PWM Operation

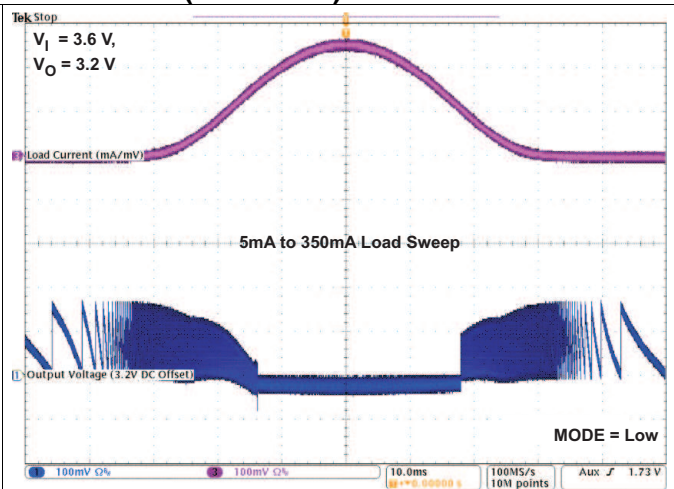

Figure 33. TPS82699 AC Load Transient Response

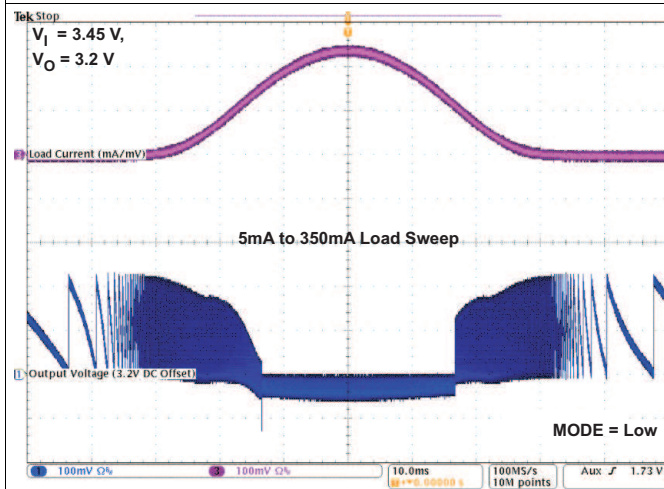

Figure 34. TPS82699 AC Load Transient Response

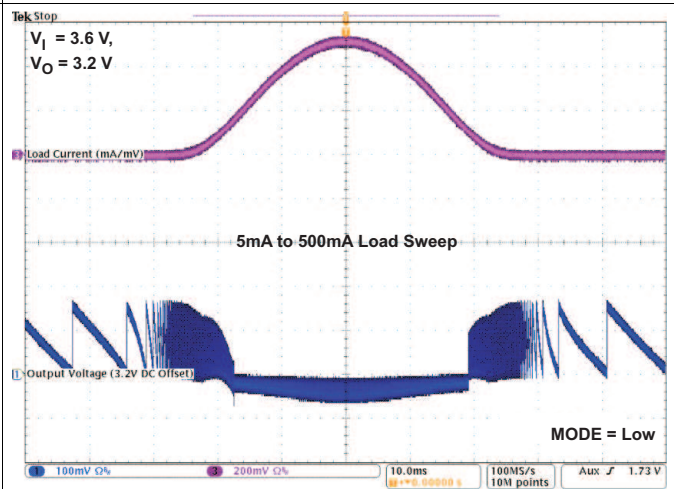

Figure 35. TPS82699 AC Load Transient Response

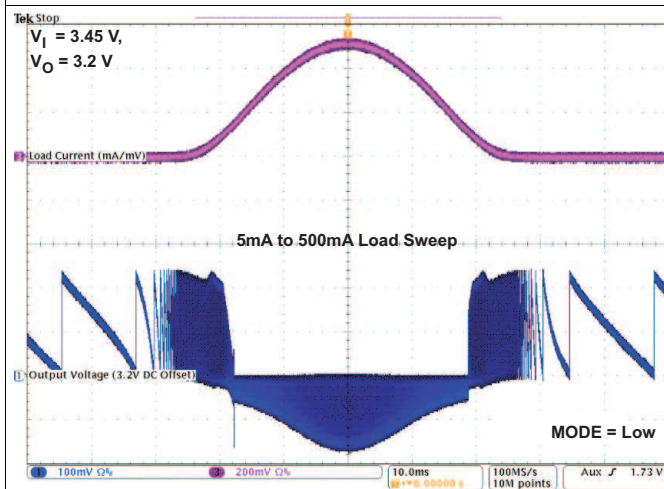

Figure 36. TPS82699 AC Load Transient Response

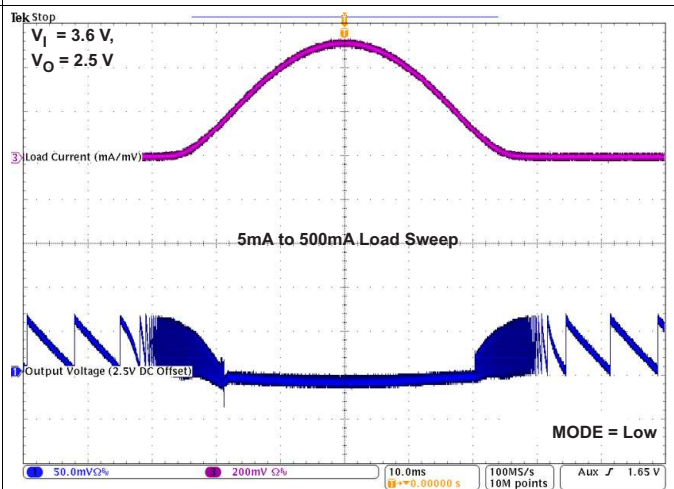

Figure 37. TPS826951 AC Load Transient Response

Parameter Measurement Information (continued)

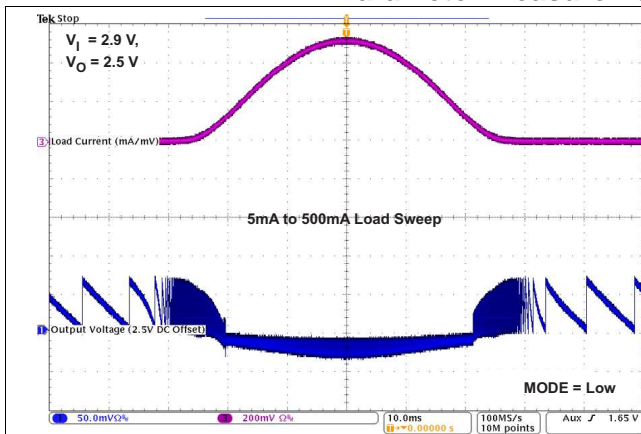

Figure 38. TPS826951 AC Load Transient Response

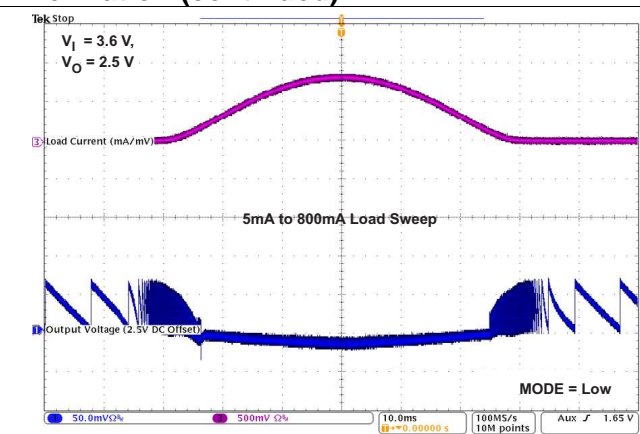

Figure 39. TPS826951 AC Load Transient Response

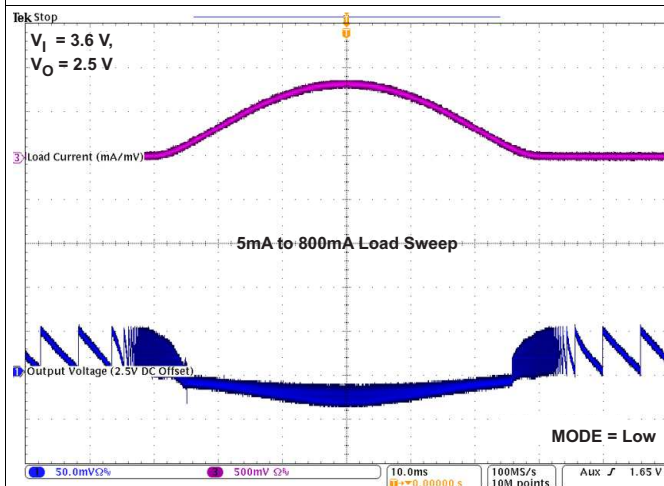

Figure 40. TPS826951 AC Load Transient Response

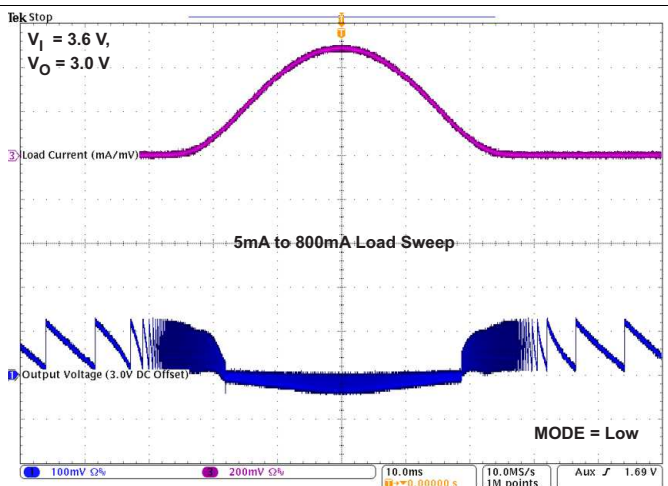

Figure 41. TPS82698 AC Load Transient Response

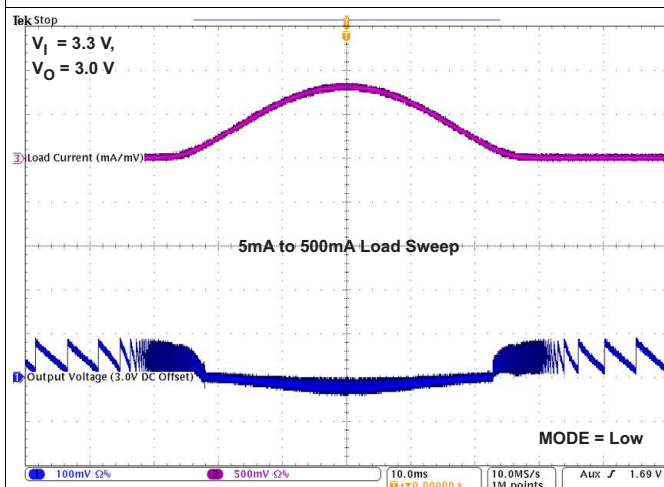

Figure 42. TPS82698 AC Load Transient Response

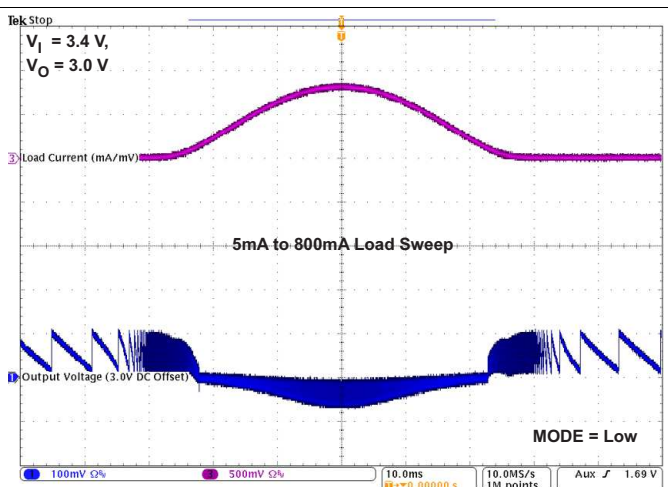

Figure 43. TPS82698 AC Load Transient Response

9 Detailed Description

9.1 Overview

The TPS8269xSIP is a standalone synchronous step-down converter operating at a regulated 3-MHz frequency pulse width modulation (PWM) at moderate to heavy load currents (up to 500mA / 800mA output current). At light load currents, the TPS8269xSIP's converter operates in power-save mode with pulse frequency modulation (PFM).

The converter uses a unique frequency locked ring oscillating modulator to achieve *best-in-class* load and line response. One key advantage of the non-linear architecture is that there is no traditional feed-back loop. The loop response to change in V_O is essentially instantaneous, which explains the transient response. Although this type of operation normally results in a switching frequency that varies with input voltage and load current, an internal frequency lock loop (FLL) holds the switching frequency constant over a large range of operating conditions.

Combined with *best in class* load and line transient response characteristics, the low quiescent current of the device (ca. 23 μ A) allows to maintain high efficiency at light load, while preserving fast transient response for applications requiring tight output regulation.

The TPS8269xSIP integrates an input current limit to protect the device against heavy load or short circuits and features an undervoltage lockout circuit to prevent the device from misoperation at low input voltages.

9.2 Functional Block Diagram

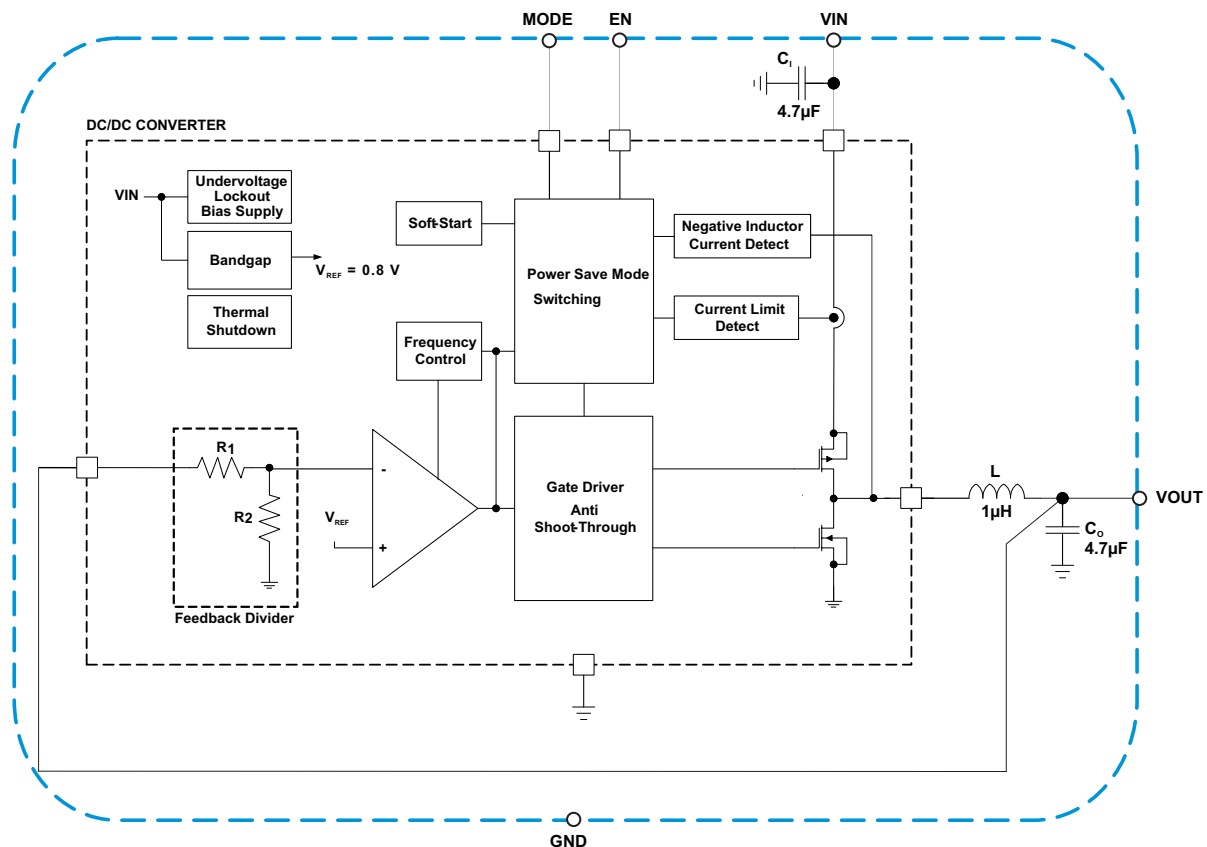

9.3 Feature Description

9.3.1 Power-Save Mode

If the load current decreases, the converter will enter Power Save Mode operation automatically. During power-save mode the converter operates in discontinuous current (DCM) with a minimum of one pulse, which produces low output ripple compared with other PFM architectures.

When in power-save mode, the converter resumes its operation when the output voltage trips below the nominal voltage. It ramps up the output voltage with a minimum of one pulse and goes into power-save mode when the output voltage is within its regulation limits again.

PFM mode is left and PWM operation is entered as the output current can no longer be supported in PFM mode. As a consequence, the DC output voltage is typically positioned ca. 1.5% above the nominal output voltage and the transition between PFM and PWM is seamless.

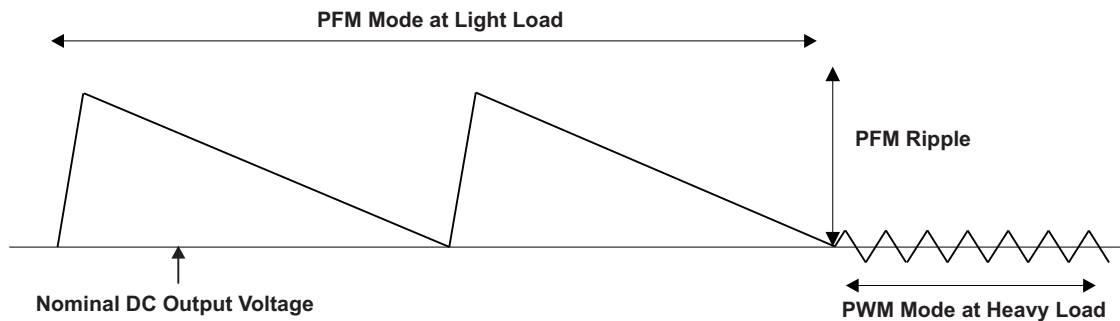

Figure 44. Operation In PFM Mode And Transfer To PWM Mode

9.3.2 Mode Selection

The MODE terminal allows to select the operating mode of the device. Connecting this terminal to GND enables the automatic PWM and power-save mode operation. The converter operates in regulated frequency PWM mode at moderate to heavy loads and in the PFM mode during light loads, which maintains high efficiency over a wide load current range.

Pulling the MODE terminal high forces the converter to operate in the PWM mode even at light load currents. The advantage is that the converter operates with a fixed frequency that allows simple filtering of the switching frequency for noise-sensitive applications. In this mode, the efficiency is lower compared to the power-save mode during light loads.

For additional flexibility, it is possible to switch from power-save mode to PWM mode during operation. This allows efficient power management by adjusting the operation of the converter to the specific system requirements.

9.3.3 Soft Start

The TPS8269xSIP has an internal soft-start circuit that limits the inrush current during start-up. This limits input voltage drops when a battery or a high-impedance power source is connected to the input of the MicroSIP™ converter.

The soft-start system progressively increases the switching on-time from a minimum pulse-width of 35ns as a function of the output voltage. This mode of operation continues for approximately 100µs after enable. Should the output voltage not have reached its target value by that time, such as in the case of heavy load, the soft-start transitions to a second mode of operation.

If the output voltage has raised above 0.5V (approximately), the converter increases the input current limit thereby enabling the power supply to come-up properly. The start-up time mainly depends on the capacitance present at the output node and load current.

9.4 Device Functional Modes

9.4.1 Low Dropout, 100% Duty Cycle Operation

The device starts to enter 100% duty cycle mode once input and output voltage come close together. In order to maintain the output voltage, the DC/DC converter's high-side MOSFET is turned on 100% for one or more cycles.

With further decreasing V_{IN} the high-side switch is constantly turned on, thereby providing a low input-to-output voltage difference. This is particularly useful in battery-powered applications to achieve longest operation time by taking full advantage of the whole battery voltage range.

9.4.2 Enable

The TPS8269xSIP device starts operation when EN is set high and starts up with the soft start as previously described. For proper operation, the EN terminal must be terminated and must not be left floating.

Pulling the EN terminal low forces the device into shutdown. In this mode, all internal circuits are turned off and V_{IN} current reduces to the device leakage current, typically a few hundred nano amps.

The TPS8269xSIP device can actively discharge the output capacitor when it turns off (See [Device Comparison](#) table). The integrated discharge resistor has a typical resistance of 100 Ω . The required time to ramp-down the output voltage depends on the load current and the capacitance present at the output node.

10 Applications and Implementation

10.1 Application Information

The TPS8269X devices are complete power supplies, optimized for and working within the given specification range without additional components or design steps. Further improvements can be achieved as described below.

10.2 Typical Application

10.2.1 Input Capacitor Selection

Because of the pulsating input current nature of the buck converter, a low ESR input capacitor is required to prevent large voltage transients that can cause misbehavior of the device or interference in other circuits in the system.

For most applications, the input capacitor that is integrated into the TPS8269x should be sufficient. If the application exhibits a noisy or erratic switching frequency, experiment with additional input ceramic capacitance to find a remedy.

The TPS8269x uses a tiny ceramic input capacitor. When a ceramic capacitor is combined with trace or cable inductance, such as from a wall adapter, a load step at the output can induce ringing at the VIN terminal. This ringing can couple to the output and be mistaken as loop instability or can even damage the part. In this circumstance, additional "bulk" capacitance, such as electrolytic or tantalum, should be placed between the input of the converter and the power source lead to reduce ringing that can occur between the inductance of the power source leads and C_1 .

10.2.2 Output Capacitor Selection

The advanced, fast-response, voltage mode, control scheme of the TPS8269x allows the use of a tiny ceramic output capacitor (C_O). For most applications, the output capacitor integrated in the TPS8269x is sufficient.

At nominal load current, the device operates in PWM mode; the overall output voltage ripple is the sum of the voltage step that is caused by the output capacitor ESL and the ripple current that flows through the output capacitor impedance. At light loads, the output capacitor limits the output ripple voltage and provides holdup during large load transitions.

The TPS8269x is designed as a Point-Of-Load (POL) regulator, to operate stand-alone without requiring any additional capacitance. Adding a 4.7 μ F ceramic output capacitor (X7R or X5R dielectric) generally works from a converter stability point of view, helps to minimize the output ripple voltage in PFM mode and improves the converter's transient response under when input and output voltage are close together.

For best operation (i.e. optimum efficiency over the entire load current range, proper PFM/PWM auto transition), the TPS8269xSIP requires a minimum output ripple voltage in PFM mode. The typical output voltage ripple is ca. 1% of the nominal output voltage V_O . The PFM pulses are time controlled resulting in a PFM output voltage ripple and PFM frequency that depends (first order) on the capacitance seen at the MicroSiP™ DC/DC converter's output.

In applications requiring additional output bypass capacitors located close to the load, care should be taken to ensure proper operation. If the converter exhibits marginal stability or erratic switching frequency, experiment with additional low value series resistance (e.g. 50 to 100m Ω) in the output path to find a remedy.

Because the damping factor in the output path is directly related to several resistive parameters (e.g. inductor DCR, power-stage $r_{DS(on)}$, PWB DC resistance, load switches $r_{DS(on)}$...) that are temperature dependant, the converter small and large signal behavior must be checked over the input voltage range, load current range and temperature range.

The easiest sanity test is to evaluate, directly at the converter's output, the following aspects:

- PFM/PWM efficiency
- PFM/PWM and forced PWM load transient response

During the recovery time from a load transient, the output voltage can be monitored for settling time, overshoot or ringing that helps judge the converter's stability. Without any ringing, the loop has usually more than 45° of phase margin.

11 Power Supply Recommendations

The TPS8269X MicroSIP™ devices are fully featured point of load power supplies. Please use information given in [Application Information](#) to connect input and output circuitry appropriately. Even if electrical characteristics are based on measurements up to $V_{IN}=5.5V$, it is not recommended to operate at higher voltages than 4.8V permanently.

12 Layout

12.1 Layout Guidelines

In making the pad size for the SiP LGA balls, it is recommended that the layout use non-solder-mask defined (NSMD) land. With this method, the solder mask opening is made larger than the desired land area, and the opening size is defined by the copper pad width. Figure 45 shows the appropriate diameters for a MicroSiP™ layout.

12.2 Layout Example

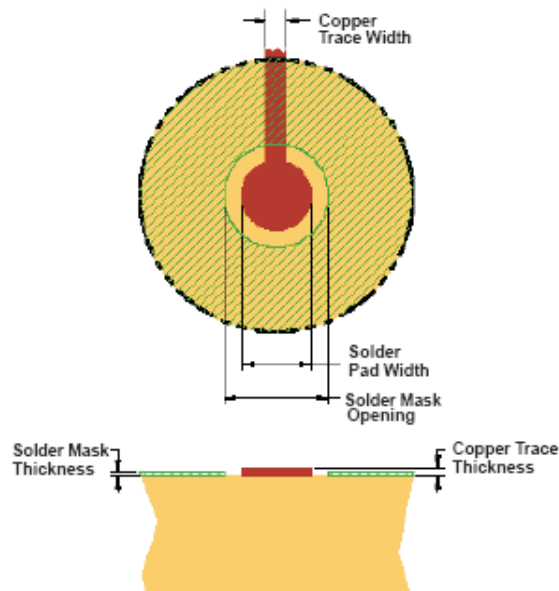

Figure 45. Recommended Land Pattern Image And Dimensions

SOLDER PAD DEFINITIONS ⁽¹⁾⁽²⁾⁽³⁾⁽⁴⁾	COPPER PAD	SOLDER MASK ⁽⁵⁾ OPENING	COPPER THICKNESS	STENCIL ⁽⁶⁾ OPENING	STENCIL THICKNESS
Non-solder-mask defined (NSMD)	0.30mm	0.360mm	1oz max (0.032mm)	0.34mm diameter	0.1mm thick

- (1) Circuit traces from non-solder-mask defined PWB lands should be 75µm to 100µm wide in the exposed area inside the solder mask opening. Wider trace widths reduce device stand off and affect reliability.
- (2) Best reliability results are achieved when the PWB laminate glass transition temperature is above the operating the range of the intended application.
- (3) Recommend solder paste is Type 3 or Type 4.
- (4) For a PWB using a Ni/Au surface finish, the gold thickness should be less than 0.5µm to avoid a reduction in thermal fatigue performance.
- (5) Solder mask thickness should be less than 20 µm on top of the copper circuit pattern.
- (6) For best solder stencil performance use laser cut stencils with electro polishing. Chemically etched stencils give inferior solder paste volume control.

12.3 Surface Mount Information

The TPS8269x MicroSiP™ DC/DC converter uses an open frame construction that is designed for a fully automated assembly process and that features a large surface area for pick and place operations. See the "Pick Area" in the package drawings.

Package height and weight have been kept to a minimum thereby allowing the MicroSiP™ device to be handled similarly to a 0805 component.

See JEDEC/IPC standard J-STD-20b for reflow recommendations.

12.4 Thermal And Reliability Information

The TPS8269x output current may need to be de-rated if it is required to operate in a high ambient temperature or deliver a large amount of continuous power. The amount of current de-rating is dependent upon the input voltage, output power and environmental thermal conditions. Care should especially be taken in applications where the localized PWB temperature exceeds 65°C.

The TPS8269x die and inductor temperature should be kept lower than the maximum rating of 125°C, so care should be taken in the circuit layout to ensure good heat sinking. Sufficient cooling should be provided to ensure reliable operation.

Three basic approaches for enhancing thermal performance are listed below:

- Improve the power dissipation capability of the PCB design.
- Improve the thermal coupling of the component to the PCB.
- Introduce airflow into the system.

To estimate the junction temperature, approximate the power dissipation within the TPS8269x by applying the typical efficiency stated in this datasheet to the desired output power; or, by taking a power measurement if you have an actual TPS8269x device or a TPS8269x evaluation module. Then calculate the internal temperature rise of the TPS8269x above the surface of the printed circuit board by multiplying the TPS8269x power dissipation by the thermal resistance.

The thermal resistance numbers listed in the Thermal Information table are based on modeling the MicroSIP™ package mounted on a high-K test board specified per JEDEC standard. For increased accuracy and fidelity to the actual application, it is recommended to run a thermal image analysis of the actual system. Figure 46 and Figure 47 are thermal images of TI's evaluation board with readings of the temperatures at specific locations on the device.

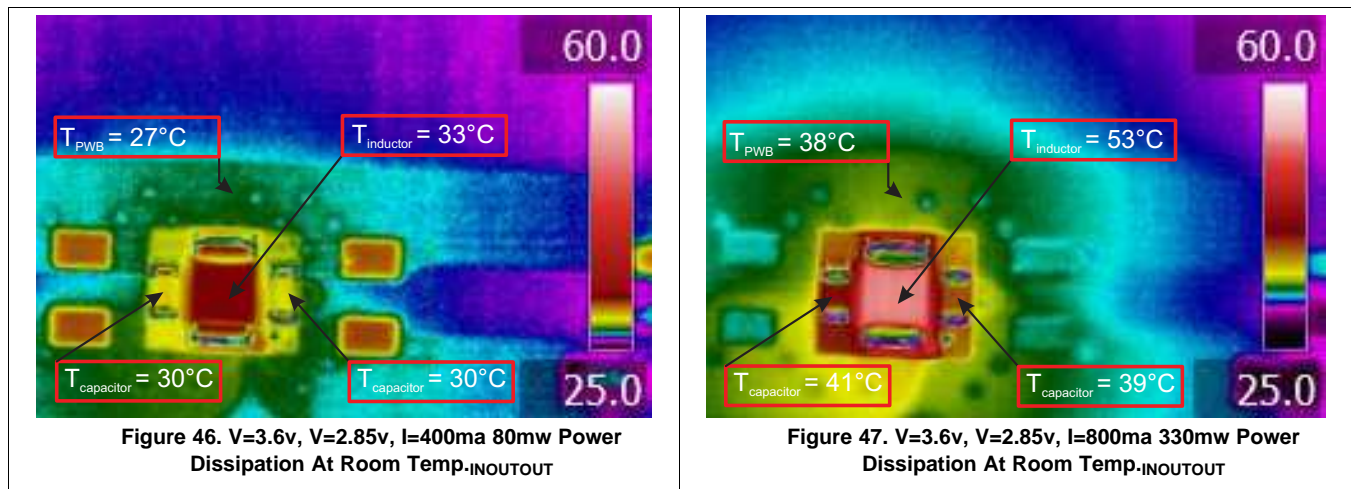

The TPS8269x is equipped with a thermal shutdown that will inhibit power switching at high junction temperatures. The activation threshold of this function, however, is above 125°C to avoid interfering with normal operation. Thus, it follows that prolonged or repetitive operation under a condition in which the thermal shutdown activates necessarily means that the components internal to the MicroSIP™ package are subjected to high temperatures for prolonged or repetitive intervals, which may damage or impair the reliability of the device.

MLCC capacitor reliability/lifetime is depending on temperature and applied voltage conditions. At higher temperatures, MLCC capacitors are subject to stronger stress. On the basis of frequently evaluated failure rates determined at standardized test conditions, the reliability of all MLCC capacitors can be calculated for their actual operating temperature and voltage.

Thermal And Reliability Information (continued)

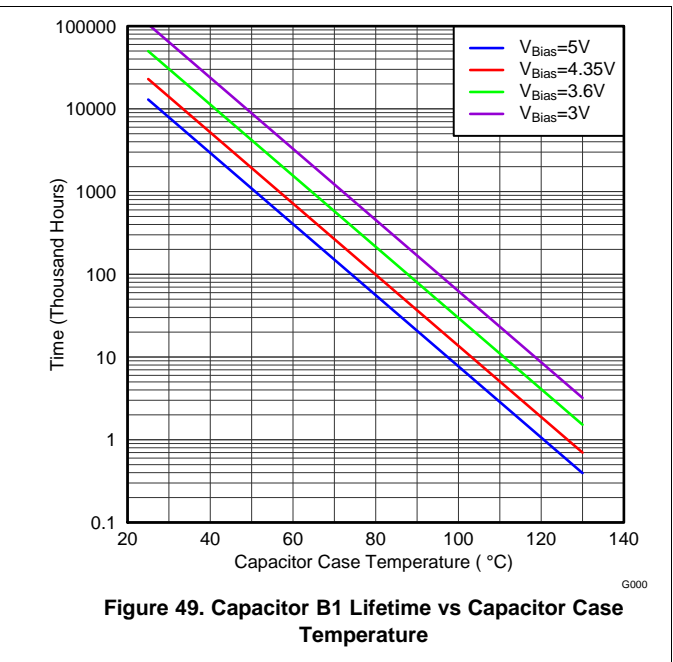
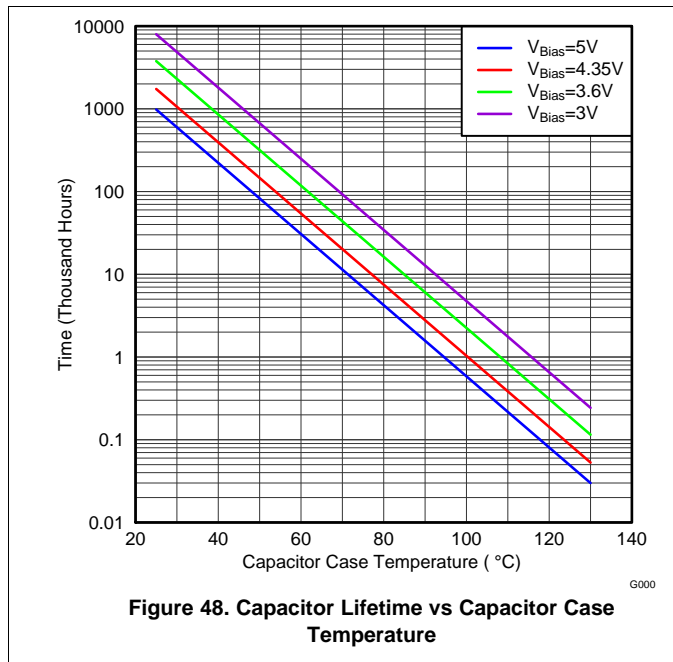

Failures caused by systematic degradation can be described by the Arrhenius model. The most critical parameter (IR) is the Insulation Resistance (i.e. leakage current). The drop of IR below a lower limit (e.g. 1 MΩ) is used as the failure criterion, see Figure 48. Figure 49 (B1 life) defines the capacitor lifetime based on a failure rate reaching 1%. It should be noted that the wear-out mechanisms occurring in the MLCC capacitors are not reversible but cumulative over time.

13 Device and Documentation Support

13.1 Documentation Support

13.1.1 Related Documentation

See [ONET-10G-EVM](#)

13.2 Related Links

The table below lists quick access links. Categories include technical documents, support and community resources, tools and software, and quick access to sample or buy.

Table 4. Related Links

PARTS	PRODUCT FOLDER	SAMPLE & BUY	TECHNICAL DOCUMENTS	TOOLS & SOFTWARE	SUPPORT & COMMUNITY
TPS82692	Click here	Click here	Click here	Click here	Click here
TPS82693	Click here	Click here	Click here	Click here	Click here
TPS826951	Click here	Click here	Click here	Click here	Click here
TPS82697	Click here	Click here	Click here	Click here	Click here
TPS82698	Click here	Click here	Click here	Click here	Click here

13.3 Trademarks

MicroSIP is a trademark of Texas Instruments.

13.4 Electrostatic Discharge Caution



These devices have limited built-in ESD protection. The leads should be shorted together or the device placed in conductive foam during storage or handling to prevent electrostatic damage to the MOS gates.

13.5 Glossary

[SLYZ022](#) — *TI Glossary*.

This glossary lists and explains terms, acronyms and definitions.

14 Mechanical, Packaging, and Orderable Information

The following pages include mechanical packaging and orderable information. This information is the most current data available for the designated devices. This data is subject to change without notice and revision of this document. For browser-based versions of this data sheet, refer to the left-hand navigation.

14.1 Package Summary

SIP Package

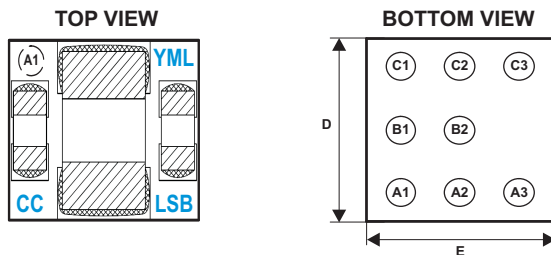

Code:

- CC — Customer Code (device/voltage specific)
- YML — Y: Year, M: Month, L: Lot trace code
- LSB — L: Lot trace code, S: Site code, B: Board locator

14.2 MicroSIP™

DC/DC Module Package Dimensioning

The TPS8269x device is available in an 8-bump ball grid array (BGA) package. The package dimensions are:

- D = 2,30 ±0,05 mm
- E = 2,90 ±0,05 mm

PACKAGING INFORMATION

Orderable Device	Status (1)	Package Type	Package Drawing	Pins	Package Qty	Eco Plan (2)	Lead/Ball Finish (6)	MSL Peak Temp (3)	Op Temp (°C)	Device Marking (4/5)	Samples
TPS82692SIPR	ACTIVE	uSiP	SIP	8	3000	Green (RoHS & no Sb/Br)	Call TI	Level-2-260C-1 YEAR	-40 to 85	E9 TXI692	Samples
TPS82692SIPT	ACTIVE	uSiP	SIP	8	250	Green (RoHS & no Sb/Br)	Call TI	Level-2-260C-1 YEAR	-40 to 85	E9 TXI692	Samples
TPS82693SIPR	ACTIVE	uSiP	SIP	8	3000	Green (RoHS & no Sb/Br)	Call TI	Level-2-260C-1 YEAR	-40 to 85	W3 TXI693	Samples
TPS82693SIPT	ACTIVE	uSiP	SIP	8	250	TBD	Call TI	Call TI	-40 to 85	W3 TXI693	Samples
TPS826951SIPR	ACTIVE	uSiP	SIP	8	3000	Green (RoHS & no Sb/Br)	Call TI	Level-2-260C-1 YEAR	-40 to 85	DO TXI695	Samples
TPS826951SIPT	ACTIVE	uSiP	SIP	8	250	Green (RoHS & no Sb/Br)	Call TI	Level-2-260C-1 YEAR	-40 to 85	DO TXI695	Samples
TPS826970SIPR	PREVIEW	uSiP	SIP	8	3000	TBD	Call TI	Call TI	-40 to 85		
TPS826970SIPT	PREVIEW	uSiP	SIP	8	250	TBD	Call TI	Call TI	-40 to 85		
TPS82697SIPR	ACTIVE	uSiP	SIP	8	3000	Green (RoHS & no Sb/Br)	Call TI	Level-2-260C-1 YEAR	-40 to 85	C2 TXI697	Samples
TPS82697SIPT	ACTIVE	uSiP	SIP	8	250	Green (RoHS & no Sb/Br)	Call TI	Level-2-260C-1 YEAR	-40 to 85	C2 TXI697	Samples
TPS82698SIPR	ACTIVE	uSiP	SIP	8	3000	Green (RoHS & no Sb/Br)	Call TI	Level-2-260C-1 YEAR	-40 to 85	WN TXI698	Samples
TPS82698SIPT	ACTIVE	uSiP	SIP	8	250	Green (RoHS & no Sb/Br)	Call TI	Level-2-260C-1 YEAR	-40 to 85	WN TXI698	Samples

(1) The marketing status values are defined as follows:

ACTIVE: Product device recommended for new designs.

LIFEBUY: TI has announced that the device will be discontinued, and a lifetime-buy period is in effect.

NRND: Not recommended for new designs. Device is in production to support existing customers, but TI does not recommend using this part in a new design.

PREVIEW: Device has been announced but is not in production. Samples may or may not be available.

OBSOLETE: TI has discontinued the production of the device.

(2) Eco Plan - The planned eco-friendly classification: Pb-Free (RoHS), Pb-Free (RoHS Exempt), or Green (RoHS & no Sb/Br) - please check <http://www.ti.com/productcontent> for the latest availability information and additional product content details.

TBD: The Pb-Free/Green conversion plan has not been defined.

Pb-Free (RoHS): TI's terms "Lead-Free" or "Pb-Free" mean semiconductor products that are compatible with the current RoHS requirements for all 6 substances, including the requirement that lead not exceed 0.1% by weight in homogeneous materials. Where designed to be soldered at high temperatures, TI Pb-Free products are suitable for use in specified lead-free processes.

Pb-Free (RoHS Exempt): This component has a RoHS exemption for either 1) lead-based flip-chip solder bumps used between the die and package, or 2) lead-based die adhesive used between the die and leadframe. The component is otherwise considered Pb-Free (RoHS compatible) as defined above.

Green (RoHS & no Sb/Br): TI defines "Green" to mean Pb-Free (RoHS compatible), and free of Bromine (Br) and Antimony (Sb) based flame retardants (Br or Sb do not exceed 0.1% by weight in homogeneous material)

⁽³⁾ MSL, Peak Temp. - The Moisture Sensitivity Level rating according to the JEDEC industry standard classifications, and peak solder temperature.

⁽⁴⁾ There may be additional marking, which relates to the logo, the lot trace code information, or the environmental category on the device.

⁽⁵⁾ Multiple Device Markings will be inside parentheses. Only one Device Marking contained in parentheses and separated by a "~" will appear on a device. If a line is indented then it is a continuation of the previous line and the two combined represent the entire Device Marking for that device.

⁽⁶⁾ Lead/Ball Finish - Orderable Devices may have multiple material finish options. Finish options are separated by a vertical ruled line. Lead/Ball Finish values may wrap to two lines if the finish value exceeds the maximum column width.

Important Information and Disclaimer: The information provided on this page represents TI's knowledge and belief as of the date that it is provided. TI bases its knowledge and belief on information provided by third parties, and makes no representation or warranty as to the accuracy of such information. Efforts are underway to better integrate information from third parties. TI has taken and continues to take reasonable steps to provide representative and accurate information but may not have conducted destructive testing or chemical analysis on incoming materials and chemicals. TI and TI suppliers consider certain information to be proprietary, and thus CAS numbers and other limited information may not be available for release.

In no event shall TI's liability arising out of such information exceed the total purchase price of the TI part(s) at issue in this document sold by TI to Customer on an annual basis.

TAPE AND REEL INFORMATION

QUADRANT ASSIGNMENTS FOR PIN 1 ORIENTATION IN TAPE

*All dimensions are nominal

Device	Package Type	Package Drawing	Pins	SPQ	Reel Diameter (mm)	Reel Width W1 (mm)	A0 (mm)	B0 (mm)	K0 (mm)	P1 (mm)	W (mm)	Pin1 Quadrant
TPS82692SIPR	uSiP	SIP	8	3000	178.0	9.0	2.45	3.05	1.1	4.0	8.0	Q2
TPS82693SIPR	uSiP	SIP	8	3000	178.0	9.0	2.45	3.05	1.1	4.0	8.0	Q2
TPS826951SIPR	uSiP	SIP	8	3000	178.0	9.0	2.45	3.05	1.1	4.0	8.0	Q2
TPS82697SIPR	uSiP	SIP	8	3000	178.0	9.0	2.45	3.05	1.1	4.0	8.0	Q2
TPS82698SIPR	uSiP	SIP	8	3000	178.0	9.0	2.45	3.05	1.1	4.0	8.0	Q2

TAPE AND REEL BOX DIMENSIONS



*All dimensions are nominal

Device	Package Type	Package Drawing	Pins	SPQ	Length (mm)	Width (mm)	Height (mm)
TPS82692SIPR	uSiP	SIP	8	3000	223.0	194.0	35.0
TPS82693SIPR	uSiP	SIP	8	3000	223.0	194.0	35.0
TPS826951SIPR	uSiP	SIP	8	3000	223.0	194.0	35.0
TPS82697SIPR	uSiP	SIP	8	3000	223.0	194.0	35.0
TPS82698SIPR	uSiP	SIP	8	3000	223.0	194.0	35.0

TPS62670SiP, TPS62690SiP, TPS82671SiP, TPS82675SiP

SIP (R-uSiP-N8)

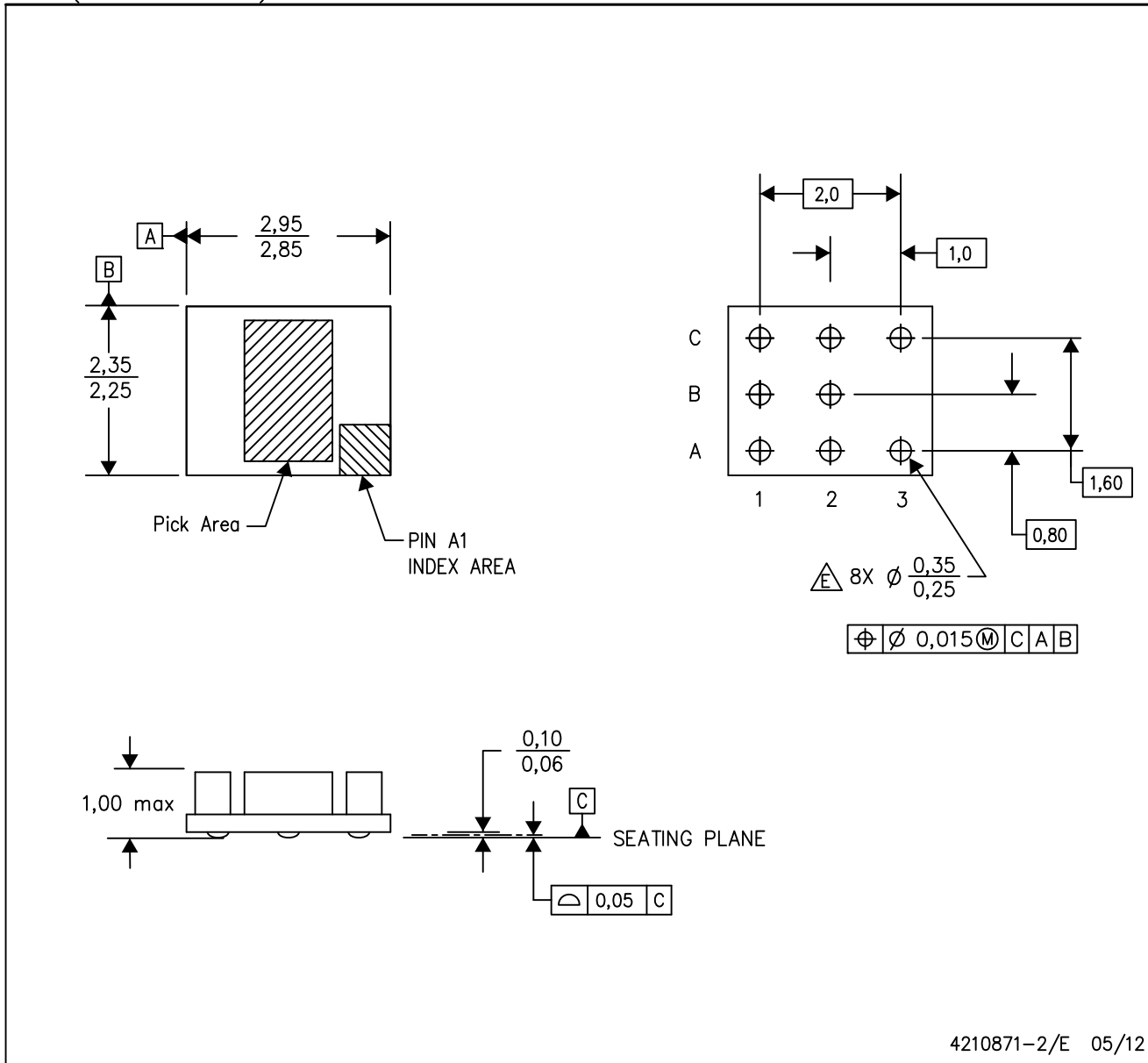
MicroSiP™



- NOTES:
- A. All linear dimensions are in millimeters. Dimensioning and tolerancing per ASME Y14.5M-1994.
 - B. This drawing is subject to change without notice.
 - C. MicroSiP™ package configuration - Micro System in Package.
 - D. Reference Product Data Sheet for array population.
3 x 3 matrix pattern is shown for illustration only.
 - E. This package contains Pb-free balls.

MicroSiP is a trademark of Texas Instruments

IMPORTANT NOTICE

Texas Instruments Incorporated and its subsidiaries (TI) reserve the right to make corrections, enhancements, improvements and other changes to its semiconductor products and services per JESD46, latest issue, and to discontinue any product or service per JESD48, latest issue. Buyers should obtain the latest relevant information before placing orders and should verify that such information is current and complete. All semiconductor products (also referred to herein as "components") are sold subject to TI's terms and conditions of sale supplied at the time of order acknowledgment.

TI warrants performance of its components to the specifications applicable at the time of sale, in accordance with the warranty in TI's terms and conditions of sale of semiconductor products. Testing and other quality control techniques are used to the extent TI deems necessary to support this warranty. Except where mandated by applicable law, testing of all parameters of each component is not necessarily performed.

TI assumes no liability for applications assistance or the design of Buyers' products. Buyers are responsible for their products and applications using TI components. To minimize the risks associated with Buyers' products and applications, Buyers should provide adequate design and operating safeguards.

TI does not warrant or represent that any license, either express or implied, is granted under any patent right, copyright, mask work right, or other intellectual property right relating to any combination, machine, or process in which TI components or services are used. Information published by TI regarding third-party products or services does not constitute a license to use such products or services or a warranty or endorsement thereof. Use of such information may require a license from a third party under the patents or other intellectual property of the third party, or a license from TI under the patents or other intellectual property of TI.

Reproduction of significant portions of TI information in TI data books or data sheets is permissible only if reproduction is without alteration and is accompanied by all associated warranties, conditions, limitations, and notices. TI is not responsible or liable for such altered documentation. Information of third parties may be subject to additional restrictions.

Resale of TI components or services with statements different from or beyond the parameters stated by TI for that component or service voids all express and any implied warranties for the associated TI component or service and is an unfair and deceptive business practice. TI is not responsible or liable for any such statements.

Buyer acknowledges and agrees that it is solely responsible for compliance with all legal, regulatory and safety-related requirements concerning its products, and any use of TI components in its applications, notwithstanding any applications-related information or support that may be provided by TI. Buyer represents and agrees that it has all the necessary expertise to create and implement safeguards which anticipate dangerous consequences of failures, monitor failures and their consequences, lessen the likelihood of failures that might cause harm and take appropriate remedial actions. Buyer will fully indemnify TI and its representatives against any damages arising out of the use of any TI components in safety-critical applications.

In some cases, TI components may be promoted specifically to facilitate safety-related applications. With such components, TI's goal is to help enable customers to design and create their own end-product solutions that meet applicable functional safety standards and requirements. Nonetheless, such components are subject to these terms.

No TI components are authorized for use in FDA Class III (or similar life-critical medical equipment) unless authorized officers of the parties have executed a special agreement specifically governing such use.

Only those TI components which TI has specifically designated as military grade or "enhanced plastic" are designed and intended for use in military/aerospace applications or environments. Buyer acknowledges and agrees that any military or aerospace use of TI components which have **not** been so designated is solely at the Buyer's risk, and that Buyer is solely responsible for compliance with all legal and regulatory requirements in connection with such use.

TI has specifically designated certain components as meeting ISO/TS16949 requirements, mainly for automotive use. In any case of use of non-designated products, TI will not be responsible for any failure to meet ISO/TS16949.

Products

Audio	www.ti.com/audio
Amplifiers	amplifier.ti.com
Data Converters	dataconverter.ti.com
DLP® Products	www.dlp.com
DSP	dsp.ti.com
Clocks and Timers	www.ti.com/clocks
Interface	interface.ti.com
Logic	logic.ti.com
Power Mgmt	power.ti.com
Microcontrollers	microcontroller.ti.com
RFID	www.ti-rfid.com
OMAP Applications Processors	www.ti.com/omap
Wireless Connectivity	www.ti.com/wirelessconnectivity

Applications

Automotive and Transportation	www.ti.com/automotive
Communications and Telecom	www.ti.com/communications
Computers and Peripherals	www.ti.com/computers
Consumer Electronics	www.ti.com/consumer-apps
Energy and Lighting	www.ti.com/energy
Industrial	www.ti.com/industrial
Medical	www.ti.com/medical
Security	www.ti.com/security
Space, Avionics and Defense	www.ti.com/space-avionics-defense
Video and Imaging	www.ti.com/video

TI E2E Community

e2e.ti.com