

FEATURES

- LIN Physical Layer Specification Revision 2.0 compliant. Conforms to SAEJ2602 Recommended Practice for LIN
- LIN Bus Speed up to 20 kbps
- ESD Protection to 12 kV (Human Body Model) on LIN Pin
- LIN Pin Handles Voltage from -40 V to +40 V
- Survives Transient Damage in Automotive Environment (ISO 7637)
- Operation with Supply from 7 V to 27 V DC
- Two Operation Modes: Normal and Low Power (Sleep) Mode
- Low Current Consumption in Low Power Mode
- Wake-Up Available from LIN Bus, Wake-Up Input (External Switch) or Host MCU
- Interfaces to MCU with 5 V or 3.3 V I/O Pins
- Dominant State Timeout Protection on TXD Pin
- Wake-Up Request on RXD Pin
- Control of External Voltage Regulator (INH Pin)
- Integrated Pull-Up Resistor and Series Diode for LIN Slave Applications
- Low EME (Electromagnetic Emissions), High EMI (Electromagnetic Immunity)
- Bus Terminal Short-Circuit Protected for Short to Battery or Short to Ground
- Thermally Protected
- Ground Disconnection Fail Safe at System Level
- Ground Shift Operation at System Level
- Unpowered Node Does Not Disturb the Network

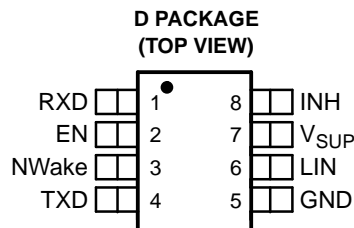

DESCRIPTION

The TPIC1021 is the LIN (Local Interconnect Network) physical interface, which integrates the serial transceiver with wake up and protection features. The LIN bus is a single wire, bi-directional bus typically used for low-speed in-vehicle networks using baud rates between 2.4 kbps and 20 kbps.

The LIN bus has two logical values: the dominant state (voltage near ground) represents a logic '0' and the recessive state (voltage near battery) and represents logic '1'.

In the recessive state the LIN bus is pulled high by the TPIC1021's internal pull-up resistor (30kΩ) and series diode, so no external pull-up components are required for slave applications. Master applications require an external pull-up resistor (1kΩ) plus a series diode.

The LIN Protocol output data stream on the TXD pin is converted by the TPIC1021 into the LIN bus signal through a current limited, wave-shaping low-side driver with control as outlined by the LIN Physical Layer Specification Revision 2.0. The receiver converts the data stream from the LIN bus and outputs the data stream via the RXD pin.

In Low Power mode, the TPIC1021 requires very low quiescent current even though the wake-up circuits remain active allowing for remote wake up via the LIN bus or local wake ups via NWake or EN pins.

The TPIC1021 has been designed for operation in the harsh automotive environment. The device can handle LIN bus voltage swing from +40 V down to ground and survive -40 V. The device also prevents back feed current through the LIN pin to the supply input in case of a ground shift or supply voltage disconnection. It also features under-voltage, over temperature, and loss of ground protection. In the event of a fault condition the output is immediately switched off and remains off until the fault condition is removed.



Please be aware that an important notice concerning availability, standard warranty, and use in critical applications of Texas Instruments semiconductor products and disclaimers thereto appears at the end of this data sheet.

TERMINAL FUNCTIONS

Terminal Assignments

PIN NAME	PIN NO.	PIN TYPE	DESCRIPTION
RXD	1	O	RXD output (open drain) pin interface reporting state of LIN bus voltage
EN	2	I	Enable input pin
NWake	3	I	High voltage input pin for device wake up
TXD	4	I	TXD input pin interface to control state of LIN output
GND	5	I	Ground connection
LIN	6	I/O	LIN bus pin single wire transmitter and receiver
V _{SUP}	7	Supply	Device supply pin (connected to battery in series with external reverse blocking diode)
INH	8	O	Inhibit pin controls external voltage regulator with inhibit input

LIN Bus Pin

This I/O pin is the single-wire LIN bus transmitter and receiver.

Transmitter Characteristics

The driver is a low side transistor with internal current limitation and thermal shutdown. There is an internal 30-k Ω pull-up resistor with a serial diode structure to V_{sup} so no external pull-up components are required for LIN slave mode applications. An external pull-up resistor of 1 k Ω plus a series diode to V_{sup} must be added when the device is used for master node applications.

Voltage on the LIN pin can go from -40 V to +40 V DC without any currents other than through the pull-up resistance. There are no reverse currents from the LIN bus to supply (V_{sup}), even in the event of a ground shift or loss of supply (V_{sup}).

The LIN thresholds and ac parameters are compatible LIN Protocol Specification Revision 2.0.

During a thermal shut down condition the driver is disabled.

Receiver Characteristics

The receiver's characteristic thresholds are ratio-metric with the device supply pin. Typical thresholds are 50%, with a hysteresis between 5% and 17.5% of supply.

Transmit Input Pin (TXD)

This pin is the interface to the MCU's LIN Protocol Controller or SCI/UART used to control the state of the LIN output. When TXD is low, LIN output is dominant (near ground). When TXD is high, LIN output is recessive (near battery). TXD input structure is compatible with microcontrollers with 3.3 V and 5.0 V I/O. This pin has an internal pull-down resistor.

TXD Dominant State Timeout

If the TXD pin is inadvertently driven permanently low by a hardware or software application failure, the LIN bus is protected by TPIC1021's Dominant State Timeout Timer. This timer is triggered by a falling edge on the TXD pin. If the low signal remains on the TXD pin for longer than t_{DST}, the transmitter is disabled thus allowing the LIN bus to return to the recessive state and communication to resume on the bus. The timer is reset by a rising edge on TXD pin.

Receive Output Pin (RXD)

This pin is the interface to the MCU's LIN Protocol Controller or SCI/UART, which reports the state of the LIN bus voltage. LIN recessive (near battery) is represented by a high level on RXD and LIN dominant (near ground) is represented by a low level on RXD. The RXD output structure is an open-drain output stage. This allows the TPIC1021 to be used with 3.3 V and 5 V I/O microcontrollers. If the microcontroller's RXD pin does not have an integrated pull-up, an external pull-up resistor to the microcontroller I/O supply voltage is required.

RXD Wake-up Request

When the TPIC1021 has been in low power mode and encounters a wake-up event from the LIN bus or NWake pin the RXD pin will go LOW while the device enters and remains in Standby Mode (until EN is re-asserted high and the device enters Normal Mode).

Supply Voltage (V_{SUP})

The TPIC1021 device power supply pin. This pin is connected to the battery through an external reverse battery blocking diode. The continuous DC operating voltage range for the TPIC1021 is from 7 V to +27 V. The V_{SUP} is protected to for harsh automotive conditions of up to + 40 V.

The device contains a reset circuit to avoid false bus messages during under-voltage conditions when V_{SUP} is less than V_{SUP_UNDER} .

Ground (GND)

TPIC1021 device ground connection. The TPIC1021 can operate with a ground shift as long as the ground shift does not reduce V_{SUP} below the minimum operating voltage. If there is a loss of ground at the ECU level, the TPIC1021 will not have a significant current consumption on the LIN pin while in the recessive state (<100 μ A sourced via the LIN pin) and for the dominant state the pull-up resistor should be active.

Enable Input Pin (EN)

The enable input pin controls the operation mode of the TPIC1021 (Normal or Low Power Mode). When enable is high, the TPIC1021 is in normal mode allowing a transmission path from TXD to LIN and from LIN to RXD. When the enable input is low, the device is put into low power (sleep) mode and there are no transmission paths. The device can enter normal operating mode only after being woken up. The enable pin has an internal pull-down resistor to ensure the device remains in low power mode even if the enable pin floats.

NWake Input Pin (NWake)

The NWake input pin is a high-voltage input used to wake up the TPIC1021 from low power mode. NWake is usually connected to an external switch in the application. A falling edge on NWake with a low that is asserted longer than the filter time (t_{NWAKE}) results in a local wake-up. The NWake pin provides an internal pull-up current source to V_{SUP} .

Inhibit Output Pin (INH)

The inhibit output pin is used to control an external voltage regulator that has an inhibit input. When the TPIC1021 is in normal operating mode, the inhibit high-side switch is enabled and the external voltage regulator is activated. When TPIC1021 is in low power mode, the inhibit switch is turned off, which disables the voltage regulator. A wake-up event on for the TPIC1021 will return the INH pin to V_{SUP} level. The INH pin output current is limited to 2 mA. The INH pin can also drive an external transistor connected to an MCU interrupt input.

Functional Block Diagram

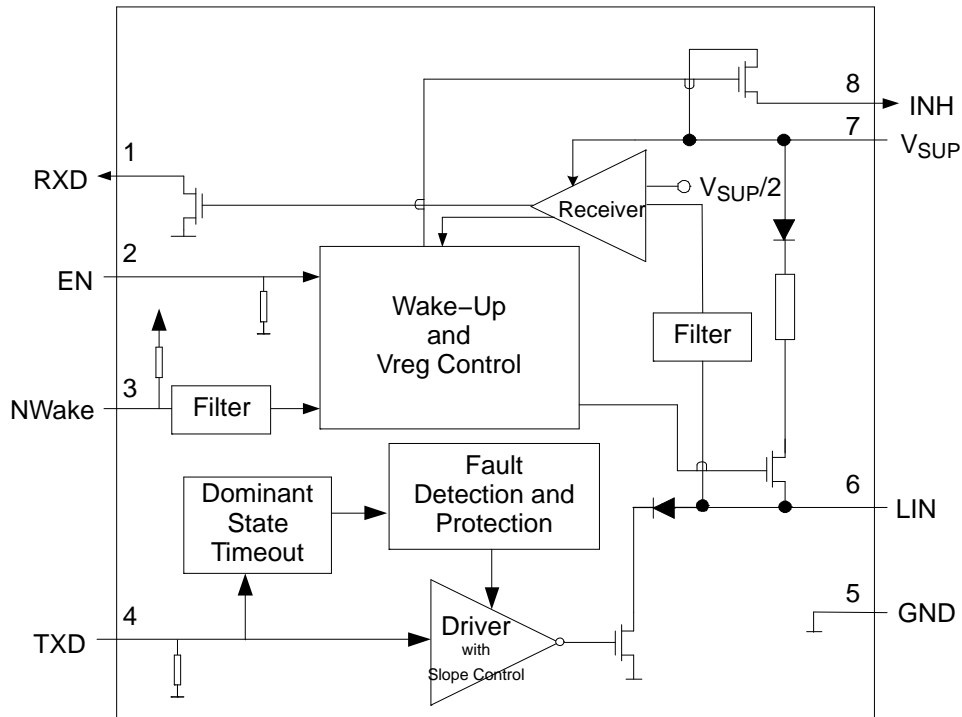

OPERATING STATES

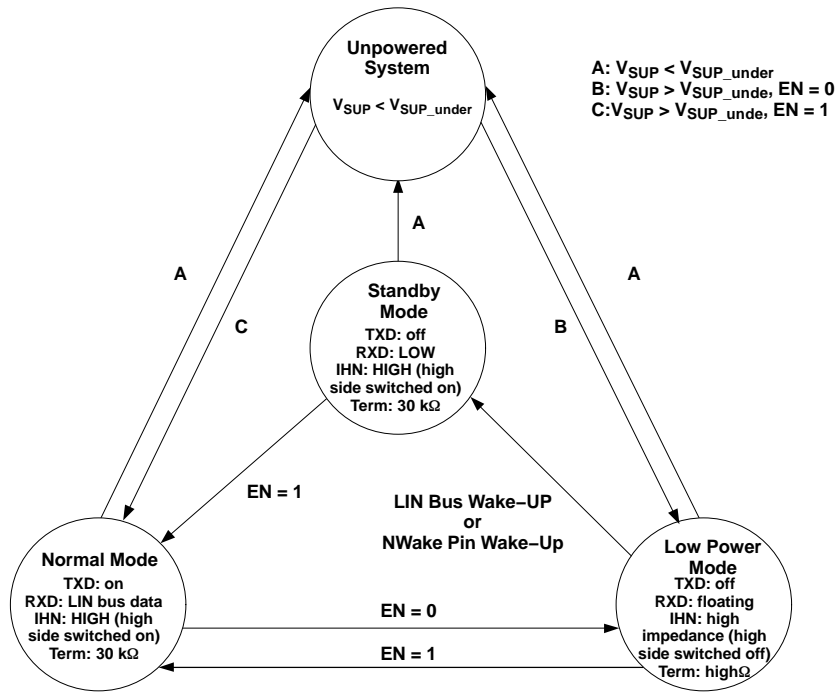

Figure 1. Operating States Diagram

OPERATING STATES (continued)

Operating Modes

MODE	EN	RXD	LIN BUS TERMINATION	INH	TRANSMITTER	COMMENTS
Low Power	0	Floating	High impedance	High impedance	Off	
Standby	0	Low	30 k Ω (typical)	High	Off	Wake-up event detected, waiting on MCU to set EN
Normal	1	LIN bus data	30 k Ω (typical)	High	On	

Normal Mode

This is the normal operational mode where the receiver and driver are active. The receiver detects the data stream on the LIN bus and outputs it on the RXD pin for the LIN controller where recessive on the LIN bus is a digital high and dominate on the LIN bus is digital low. The driver will transmit input data on the TXD pin to the LIN bus.

Low Power Mode

The power saving mode for the TPIC1021 and the default state after power-up (assuming EN=0). Even with the extremely low current consumption in this mode, the TPIC1021 can still wake-up from LIN bus activity, a falling edge on the NWake pin or if EN is set high. The LIN bus and NWake pins are filtered to prevent false wake-up events. The wake-up events must be active for their respective time periods: t_{LINBUS} , t_{NWake} .

The low power mode is entered by setting the EN pin low.

While the device is in low power mode the following conditions exist:

- The LIN bus driver is disabled and the internal LIN bus termination is switched off (to minimize power loss if LIN is short-circuited to ground).
- The normal receiver is disabled.
- The INH pin is high impedance.
- EN input, NWake input and the LIN wake-up receiver are active.

Wake-Up Events

There are three ways to wake-up the TPIC1021 from Low Power Mode.

- Remote wake-up via recessive (high) to dominant (low) state transition on LIN Bus where dominant bus state of 50% threshold is detected. The dominant state must be held for t_{LINBUS} filter time (to eliminate false wake ups from disturbances on the LIN Bus).
- Local wake-up via falling edge on NWake pin which is held low for filter time t_{NWake} (to eliminate false wake ups from disturbances on NWake).
- Local wake-up via EN being set high

Standby Mode

This mode is entered whenever a wake-up event occurs via the LIN bus or NWake pin while the TPIC1021 is in low power mode. The LIN bus slave termination circuit and the INH pin are turned on when standby mode is entered. The application system will power up once the INH pin is turn assuming it is using a voltage regulator connected via INH pin. Standby Mode is signaled via a low level on RXD pin.

When EN pin is set high while the TPIC1021 is in Standby Mode the device returns to Normal Mode and the normal transmission paths from TXD to LIN bus and LIN bus to RXD are turned on.

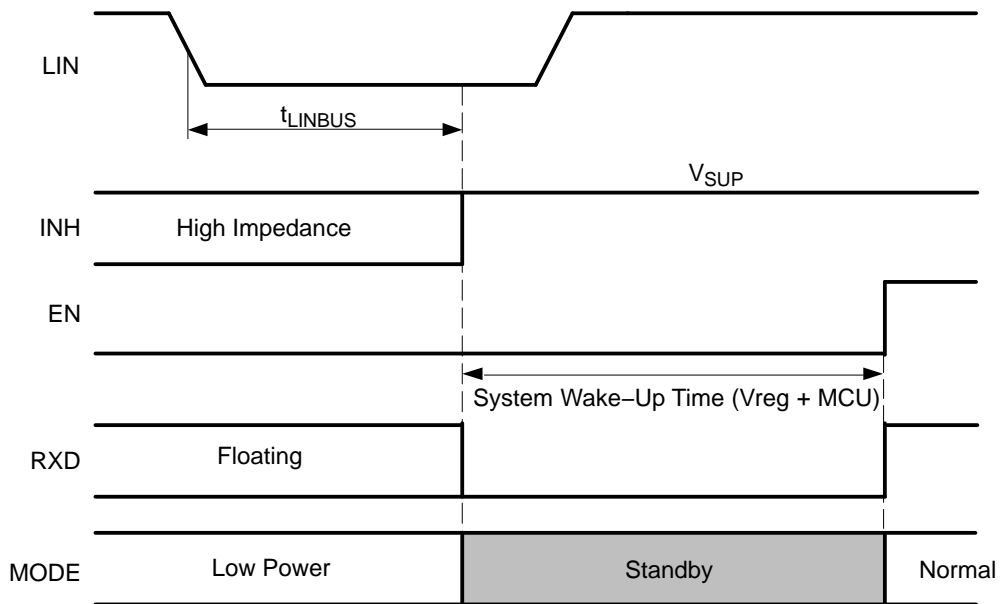

Figure 2. Wake-Up Via LIN Bus Timing Diagram

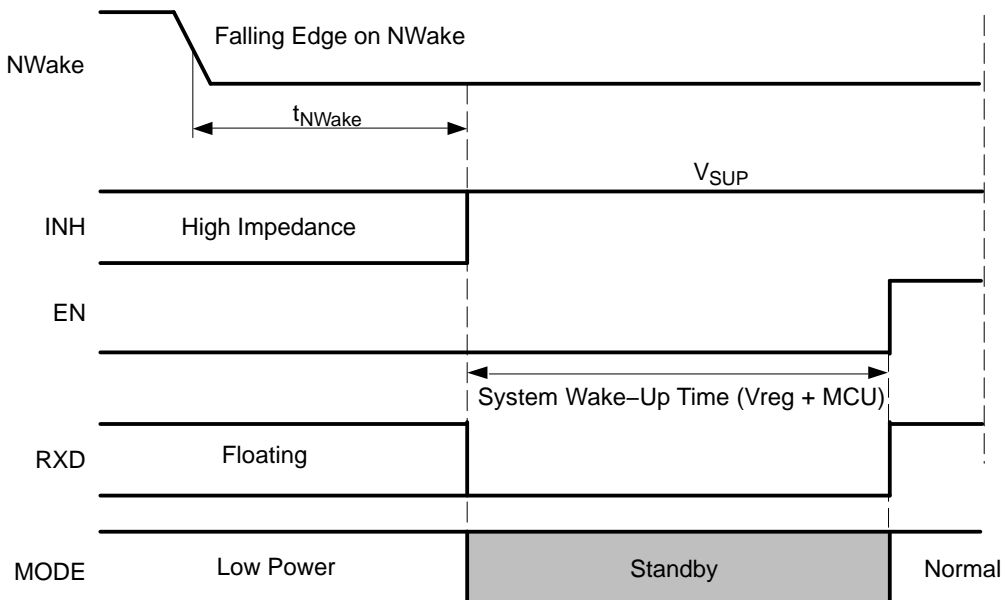

Figure 3. Wake-Up Via NWake Timing Diagram

ABSOLUTE MAXIMUM RATINGS⁽¹⁾

over operating free-air temperature range (unless otherwise noted)

PARAMETER		RATING	UNIT
V _{SUP} ⁽²⁾	Supply line supply voltage (continuous)	0 to 27	V
	Supply line supply voltage (transient)	0 to 40	V
	NWake DC and transient input voltage (through 33-kΩ serial resistor)	-1 to 40	V
	Logic pin input voltage (RXD, TXD, EN)	-0.3 to 5.5	V
	LIN DC input voltage	-40 to 40	V
	Electrostatic discharge: Human Body Model: LIN pin ⁽³⁾	-12 to 12	kV
	Electrostatic discharge: Human Body Model: NWake pin ⁽³⁾	-9 to 9	kV
	Electrostatic discharge: Human Body Model: All other pins ⁽³⁾	-3 to 3	kV
	Electrostatic discharge: Machine Model: LIN and NWake pins ⁽⁴⁾	-400 to 400	V
	Electrostatic discharge: Machine Model: All other pins ⁽⁴⁾	-200 to 200	V
T _A	Operational free-air temperature	-40 to 125	°C
T _J	Junction temperature	-40 to 150	°C
T _{stg}	Storage temperature	-40 to 165	°C
R _{θJA}	Thermal resistance, junction-to-ambient	145	°C/W
	Thermal shutdown	200	°C
	Thermal shutdown hysteresis	25	°C

(1) Stresses beyond those listed under “absolute maximum ratings” may cause permanent damage to the device. These are stress ratings only and functional operation of the device at these or any other conditions beyond those indicated under “recommended operating conditions” is not implied. Exposure to absolute-maximum-rated conditions for extended periods may affect device reliability.

(2) All voltage values are with respect to GND.

(3) The human body model is a 100-pF capacitor discharged through a 1.5-kΩ resistor into each pin.

(4) The machine model is a 200-pF capacitor through a 10-Ω resistor and a 0.75-μH coil.

ELECTRICAL CHARACTERISTICS

$V_{SUP} = 7\text{ V to }27\text{ V}$, $T_A = -40^\circ\text{C to }125^\circ\text{C}$ (unless otherwise noted)

PARAMETER		TEST CONDITIONS	MIN	TYP ⁽¹⁾	MAX	UNIT
SUPPLY						
	Operational supply voltage ⁽²⁾		7	14	27	V
	Nominal supply line voltage ⁽²⁾		7	14	18	V
	V_{SUP} undervoltage threshold ⁽²⁾			4.5		V
I_{CC}	Supply Current	Normal Mode, EN = 1, Bus dominant (total bus load > 500 Ω) ⁽³⁾		1.2	2.5	mA
		Standby Mode, EN = 0, Bus dominant (total bus load > 500 Ω) ⁽³⁾		1	2.1	mA
		Normal Mode, EN = 1, Bus recessive		300	500	μA
		Standby Mode, EN = 0, Bus recessive		300	500	μA
		Low Power Mode, EN = 0, $V_{SUP} < 14\text{ V}$, $NW_{wake} = V_{SUP}$, $LIN = V_{SUP}$		20	50	μA
		Low Power Mode, EN = 0, $14\text{ V} < V_{SUP} < 27\text{ V}$, $NW_{wake} = V_{SUP}$, $LIN = V_{SUP}$		50	100	μA
RXD OUTPUT PIN						
V_O	Output voltage		-0.3		5.5	V
I_{OL}	Low-level output current, open drain	$LIN = 0\text{ V}$, $RXD = 0.4\text{ V}$	3.5			mA
I_{IKG}	Leakage current, high-level	$LIN = V_{SUP}$, $RXD = 5\text{ V}$	-5	0	5	μA
TXD INPUT PIN						
V_{IL}	Low-level input voltage ⁽²⁾		-0.3		0.8	V
V_{IH}	High-level input voltage ⁽²⁾		2		5.5	V
V_{IT}	Input threshold hysteresis voltage ⁽²⁾		30		500	mV
	Pull-down resistor		125	350	800	k Ω
I_{iL}	Low-level input current	TXD = 0	-5	0	5	μA
LIN PIN (Referenced to V_{SUP})						
V_{OH}	High-level output voltage ⁽²⁾	LIN recessive, TXD = High, $I_O = 0\text{ mA}$	$V_{SUP}-1\text{ V}$			V
V_{OL}	Low-level output voltage ⁽²⁾	LIN dominant, TXD = Low, $I_O = 40\text{ mA}$	0		$0.2 \times V_{SUP}$	V
	Pull-up resistor to V_{SUP}		20	30	60	k Ω
I_L	Limiting current	TXD = Low	50	150	250	mA
I_{IKG}	Leakage current	$LIN = V_{SUP}$	-5	0	5	μA
V_{iL}	Low-level input voltage ⁽²⁾	LIN dominant	$0 \times V_{SUP}$		$0.4 \times V_{SUP}$	V
V_{iH}	High-level input voltage ⁽²⁾	LIN recessive	$0.6 \times V_{SUP}$		V_{SUP}	V
V_{iT}	Input threshold voltage ⁽²⁾		$0.4 \times V_{SUP}$	$0.5 \times V_{SUP}$	$0.6 \times V_{SUP}$	V
V_{hys}	Hysteresis voltage ⁽²⁾		$0.05 \times V_{SUP}$		$0.175 \times V_{SUP}$	V
V_{iL}	Low-level input voltage for wake-up ⁽²⁾		0		$0.4 \times V_{SUP}$	V
EN PIN						
V_{iL}	Low-level input voltage ⁽²⁾		-0.3		0.8	V
V_{iH}	High-level input voltage ⁽²⁾		2		5.5	V
V_{hys}	Hysteresis voltage ⁽²⁾		30		500	mV

(1) Typical values are give for $V_{SUP} = 14\text{ V}$ at 25°C .

(2) All voltages are defined with respect to ground; positive currents flow into the TPIC1021 device.

(3) In the dominant state the supply current increases as the supply voltage increases due to the integrated LIN slave termination resistance. At higher voltages the majority of supply current is through the termination resistance. The minimum resistance of the LIN slave termination is 20 k Ω so the maximum supply current attributed to the termination is: $I_{SUP}(\text{dom})_{\text{max termination}} \approx (V_{SUP} - (V_{LIN_Dominant} + 0.7\text{ V}) / 20\text{ k}\Omega$.

ELECTRICAL CHARACTERISTICS (continued)

$V_{SUP} = 7\text{ V to }27\text{ V}$, $T_A = -40^\circ\text{C to }125^\circ\text{C}$ (unless otherwise noted)

PARAMETER		TEST CONDITIONS	MIN	TYP ⁽¹⁾	MAX	UNIT
	Pull-down resistor		125	350	800	k Ω
I_{IL}	Low-level input current	EN = 0 V	-5	0	5	μA
INH PIN						
V_o	DC output voltage	Transient voltage	-0.3		$V_{SUP}+0.3$	V
I_o	Output current		-50		2	mA
R_{on}	On state resistance	Between V_{SUP} and INH, INH = 2 mA drive, Normal or Standby Mode	25	40	100	Ω
I_{IKG}	Leakage current	Low Power mode, $0 < \text{INH} < V_{SUP}$	-5	0	5	μA
NWake PIN						
V_{IL}	Low-level input voltage ⁽⁴⁾		-0.3		$V_{SUP}-3.3$	V
V_{IH}	High-level input voltage ⁽⁴⁾		$V_{SUP}-1$		$V_{SUP}+0.3$	V
	Pull-up current	NWake = 0 V	-40	-10	-4	μA
I_{IKG}	Leakage current	$V_{SUP} = \text{NWake}$	-5	0	5	μA
THERMAL SHUTDOWN						
	Shutdown junction thermal temperature			185		$^\circ\text{C}$
AC CHARACTERISTICS						
D1	Duty cycle 1 ⁽⁵⁾⁽⁶⁾	$TH_{REC(max)} = 0.744 \times V_{SUP}$, $TH_{DOM(max)} = 0.581 \times V_{SUP}$, $V_{SUP} = 7.0\text{ V to }18\text{ V}$, $t_{BIT} = 50\ \mu\text{s}$ (20 kbps), See Figure 4	0.396			
D2	Duty cycle 2 ⁽⁵⁾⁽⁶⁾	$TH_{REC(max)} = 0.284 \times V_{SUP}$, $TH_{DOM(max)} = 0.422 \times V_{SUP}$, $V_{SUP} = 7.6\text{ V to }18\text{ V}$, $t_{BIT} = 50\ \mu\text{s}$ (20 kbps), See Figure 4			0.581	
D3	Duty cycle 3 ⁽⁵⁾⁽⁶⁾	$TH_{REC(max)} = 0.778 \times V_{SUP}$, $TH_{DOM(max)} = 0.616 \times V_{SUP}$, $V_{SUP} = 7.0\text{ V to }18\text{ V}$, $t_{BIT} = 96\ \mu\text{s}$ (10.4 kbps), See Figure 4	0.417			
D4	Duty cycle 4 ⁽⁵⁾⁽⁶⁾	$TH_{REC(max)} = 0.251 \times V_{SUP}$, $TH_{DOM(max)} = 0.389 \times V_{SUP}$, $V_{SUP} = 7.6\text{ V to }18\text{ V}$, $t_{BIT} = 96\ \mu\text{s}$ (10.4 kbps), See Figure 4			0.590	
t_{rx_pdr}	Receiver rising propagation delay time	$R_L = 2.4\text{ k}\Omega$, $C_L = 20\text{ pF}$, See Figure 4			6	μs
t_{rx_pdf}	Receiver falling propagation delay time	$R_L = 2.4\text{ k}\Omega$, $C_L = 20\text{ pF}$, See Figure 4			6	μs
t_{rx_sym}	Symmetry of receiver propagation delay time (rising edge)	wrt falling edge, See Figure 4	-2		2	μs
t_{NWake}	NWake filter time for local wake-up	See Figure 4	25	50	100	μs
t_{LINBUS}	LIN wake-up filter time (dominant time for wake-up via LIN bus)	See Figure 4	25	50	100	μs
t_{DST}	Dominant state timeout ⁽⁷⁾	See Figure 4	6	9	14	ms

(4) All voltages are defined with respect to ground; positive currents flow into the TPIC1021 device.

(5) Duty cycle = $t_{BUS_rec(min)} / (2 \times t_{BIT})$

(6) Duty Cycles: LIN Driver bus load conditions (CLINBUS, RLINBUS): Load1 = 1 nF, 1 k Ω ; Load2 = 6.8 nF, 660 Ω ; Load3 = 10 nF, 500 Ω . Duty Cycles 3 and 4 are defined for 10.4 kbps operation. The TPIC1021 also meets these lower speed requirements, while it is capable of the higher speed 20.0 kbps operation as specified by Duty Cycles 1 and 2. SAEJ2602 derives propagation delay equations from the LIN 2.0 duty cycle definitions, for details please refer to the SAEJ2602 specification.

(7) Dominant state timeout will limit the minimum data rate to 2.4 kbps.

TIMING DIAGRAMS

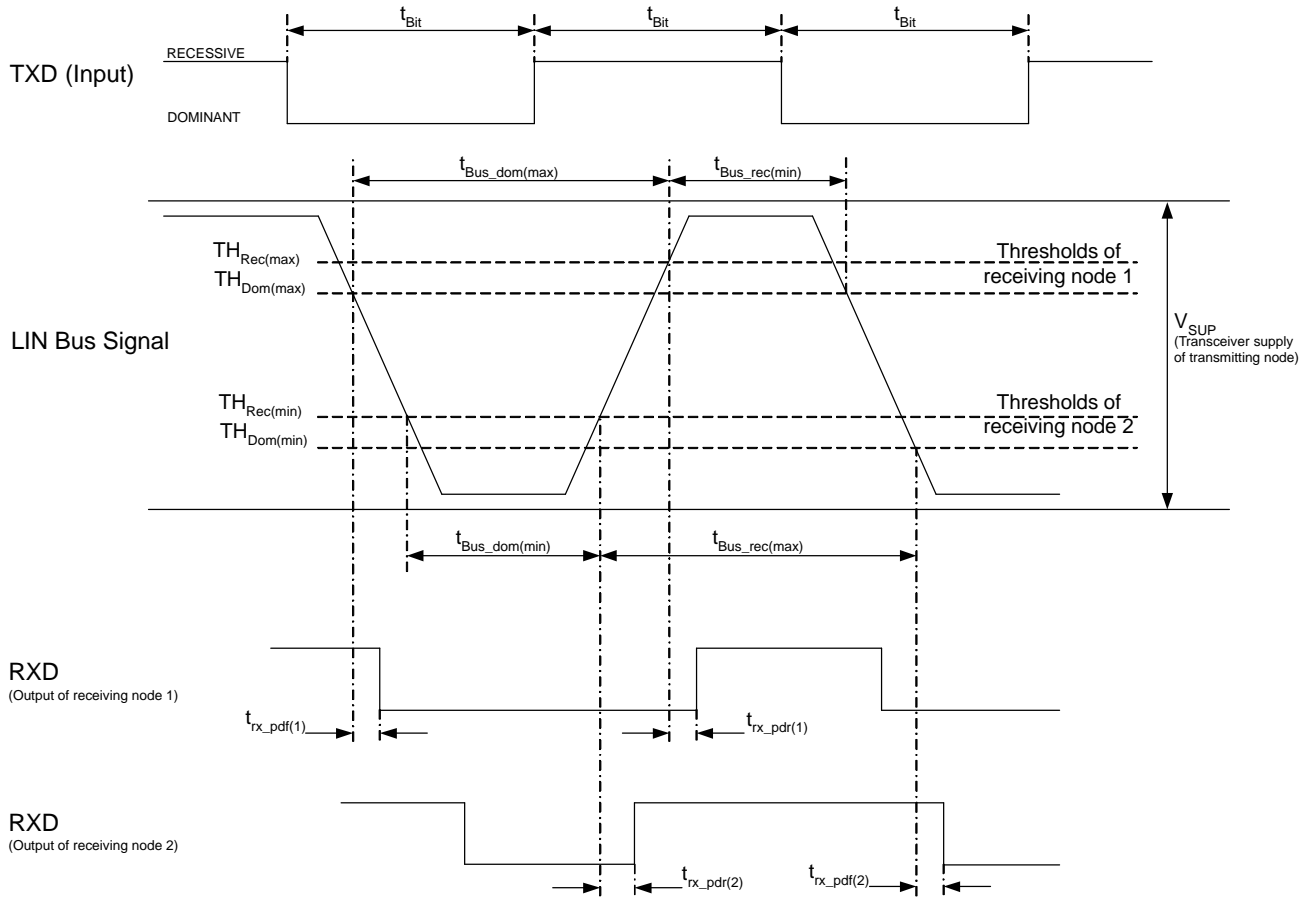
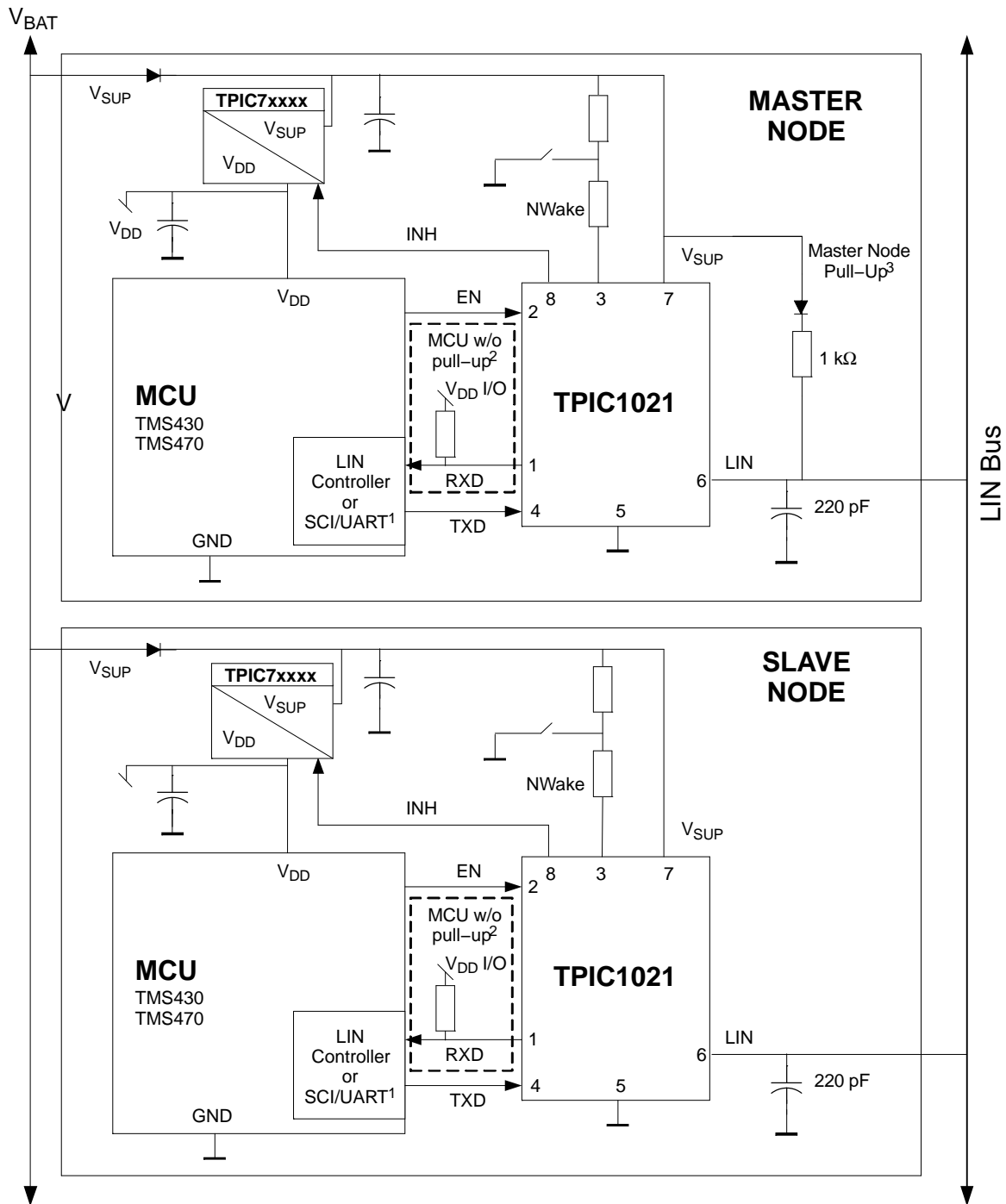

Figure 4. Definition of Bus Timing Parameters

APPLICATION INFORMATION



- (1) RXD on MCU or LIN Slave has internal pull-up, no external pull-up resistor is needed.
- (2) RXD on MCU or LIN Slave without internal pull-up, requires external pull-up resistor.
- (3) Master Node applications require an external 1-kΩ pull-up resistor and serial diode.

Figure 5.

PACKAGING INFORMATION

Orderable Device	Status (1)	Package Type	Package Drawing	Pins	Package Qty	Eco Plan (2)	Lead/Ball Finish	MSL Peak Temp (3)	Op Temp (°C)	Top-Side Markings (4)	Samples
TPIC1021D	ACTIVE	SOIC	D	8	75	Green (RoHS & no Sb/Br)	CU NIPDAU	Level-1-260C-UNLIM	-40 to 125	T1021	Samples
TPIC1021DG4	ACTIVE	SOIC	D	8	75	Green (RoHS & no Sb/Br)	CU NIPDAU	Level-1-260C-UNLIM		T1021	Samples
TPIC1021DR	ACTIVE	SOIC	D	8	2500	Green (RoHS & no Sb/Br)	CU NIPDAU	Level-1-260C-UNLIM	-40 to 125	T1021	Samples
TPIC1021DRG4	ACTIVE	SOIC	D	8	2500	Green (RoHS & no Sb/Br)	CU NIPDAU	Level-1-260C-UNLIM		T1021	Samples

(1) The marketing status values are defined as follows:

ACTIVE: Product device recommended for new designs.

LIFEBUY: TI has announced that the device will be discontinued, and a lifetime-buy period is in effect.

NRND: Not recommended for new designs. Device is in production to support existing customers, but TI does not recommend using this part in a new design.

PREVIEW: Device has been announced but is not in production. Samples may or may not be available.

OBSOLETE: TI has discontinued the production of the device.

(2) Eco Plan - The planned eco-friendly classification: Pb-Free (RoHS), Pb-Free (RoHS Exempt), or Green (RoHS & no Sb/Br) - please check <http://www.ti.com/productcontent> for the latest availability information and additional product content details.

TBD: The Pb-Free/Green conversion plan has not been defined.

Pb-Free (RoHS): TI's terms "Lead-Free" or "Pb-Free" mean semiconductor products that are compatible with the current RoHS requirements for all 6 substances, including the requirement that lead not exceed 0.1% by weight in homogeneous materials. Where designed to be soldered at high temperatures, TI Pb-Free products are suitable for use in specified lead-free processes.

Pb-Free (RoHS Exempt): This component has a RoHS exemption for either 1) lead-based flip-chip solder bumps used between the die and package, or 2) lead-based die adhesive used between the die and leadframe. The component is otherwise considered Pb-Free (RoHS compatible) as defined above.

Green (RoHS & no Sb/Br): TI defines "Green" to mean Pb-Free (RoHS compatible), and free of Bromine (Br) and Antimony (Sb) based flame retardants (Br or Sb do not exceed 0.1% by weight in homogeneous material)

(3) MSL, Peak Temp. -- The Moisture Sensitivity Level rating according to the JEDEC industry standard classifications, and peak solder temperature.

(4) Multiple Top-Side Markings will be inside parentheses. Only one Top-Side Marking contained in parentheses and separated by a "~" will appear on a device. If a line is indented then it is a continuation of the previous line and the two combined represent the entire Top-Side Marking for that device.

Important Information and Disclaimer: The information provided on this page represents TI's knowledge and belief as of the date that it is provided. TI bases its knowledge and belief on information provided by third parties, and makes no representation or warranty as to the accuracy of such information. Efforts are underway to better integrate information from third parties. TI has taken and continues to take reasonable steps to provide representative and accurate information but may not have conducted destructive testing or chemical analysis on incoming materials and chemicals. TI and TI suppliers consider certain information to be proprietary, and thus CAS numbers and other limited information may not be available for release.

In no event shall TI's liability arising out of such information exceed the total purchase price of the TI part(s) at issue in this document sold by TI to Customer on an annual basis.

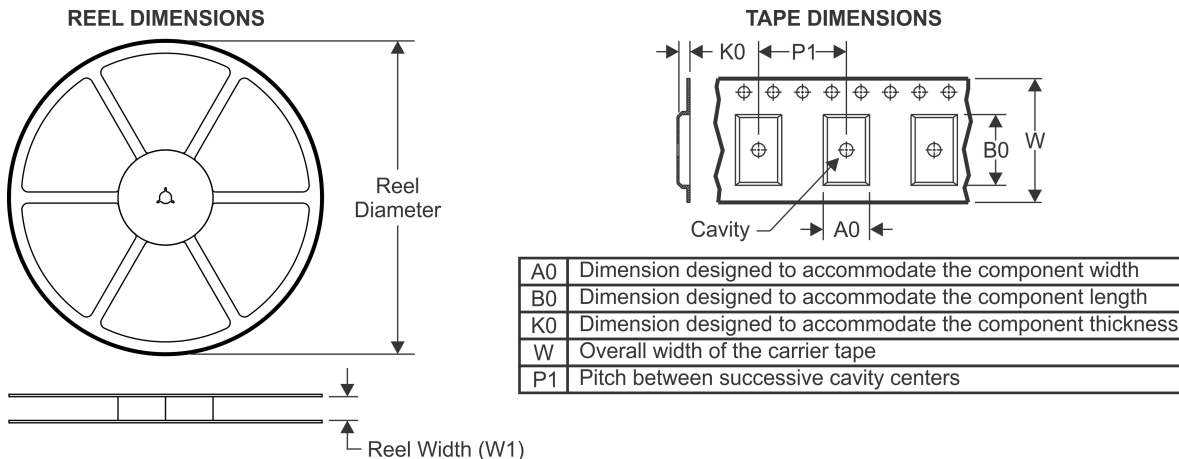
TAPE AND REEL INFORMATION

QUADRANT ASSIGNMENTS FOR PIN 1 ORIENTATION IN TAPE

*All dimensions are nominal

Device	Package Type	Package Drawing	Pins	SPQ	Reel Diameter (mm)	Reel Width W1 (mm)	A0 (mm)	B0 (mm)	K0 (mm)	P1 (mm)	W (mm)	Pin1 Quadrant
TPIC1021DR	SOIC	D	8	2500	330.0	12.4	6.4	5.2	2.1	8.0	12.0	Q1
TPIC1021DRG4	SOIC	D	8	2500	330.0	12.4	6.4	5.2	2.1	8.0	12.0	Q1

TAPE AND REEL BOX DIMENSIONS



*All dimensions are nominal

Device	Package Type	Package Drawing	Pins	SPQ	Length (mm)	Width (mm)	Height (mm)
TPIC1021DR	SOIC	D	8	2500	367.0	367.0	35.0
TPIC1021DRG4	SOIC	D	8	2500	367.0	367.0	35.0

D (R-PDSO-G8)

PLASTIC SMALL OUTLINE

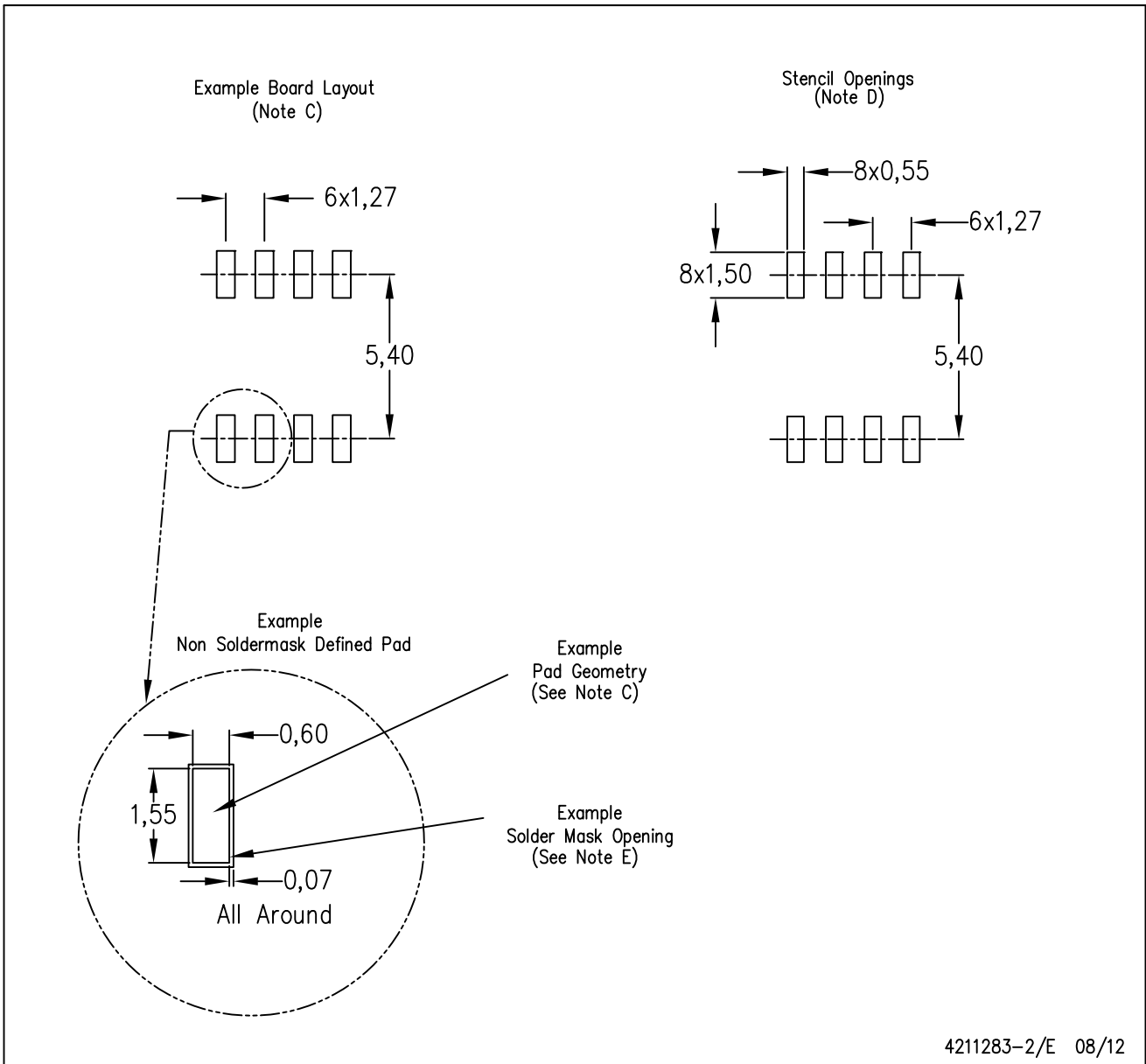

4211283-2/E 08/12

- NOTES:
- A. All linear dimensions are in millimeters.
 - B. This drawing is subject to change without notice.
 - C. Publication IPC-7351 is recommended for alternate designs.
 - D. Laser cutting apertures with trapezoidal walls and also rounding corners will offer better paste release. Customers should contact their board assembly site for stencil design recommendations. Refer to IPC-7525 for other stencil recommendations.
 - E. Customers should contact their board fabrication site for solder mask tolerances between and around signal pads.

IMPORTANT NOTICE

Texas Instruments Incorporated and its subsidiaries (TI) reserve the right to make corrections, enhancements, improvements and other changes to its semiconductor products and services per JESD46, latest issue, and to discontinue any product or service per JESD48, latest issue. Buyers should obtain the latest relevant information before placing orders and should verify that such information is current and complete. All semiconductor products (also referred to herein as "components") are sold subject to TI's terms and conditions of sale supplied at the time of order acknowledgment.

TI warrants performance of its components to the specifications applicable at the time of sale, in accordance with the warranty in TI's terms and conditions of sale of semiconductor products. Testing and other quality control techniques are used to the extent TI deems necessary to support this warranty. Except where mandated by applicable law, testing of all parameters of each component is not necessarily performed.

TI assumes no liability for applications assistance or the design of Buyers' products. Buyers are responsible for their products and applications using TI components. To minimize the risks associated with Buyers' products and applications, Buyers should provide adequate design and operating safeguards.

TI does not warrant or represent that any license, either express or implied, is granted under any patent right, copyright, mask work right, or other intellectual property right relating to any combination, machine, or process in which TI components or services are used. Information published by TI regarding third-party products or services does not constitute a license to use such products or services or a warranty or endorsement thereof. Use of such information may require a license from a third party under the patents or other intellectual property of the third party, or a license from TI under the patents or other intellectual property of TI.

Reproduction of significant portions of TI information in TI data books or data sheets is permissible only if reproduction is without alteration and is accompanied by all associated warranties, conditions, limitations, and notices. TI is not responsible or liable for such altered documentation. Information of third parties may be subject to additional restrictions.

Resale of TI components or services with statements different from or beyond the parameters stated by TI for that component or service voids all express and any implied warranties for the associated TI component or service and is an unfair and deceptive business practice. TI is not responsible or liable for any such statements.

Buyer acknowledges and agrees that it is solely responsible for compliance with all legal, regulatory and safety-related requirements concerning its products, and any use of TI components in its applications, notwithstanding any applications-related information or support that may be provided by TI. Buyer represents and agrees that it has all the necessary expertise to create and implement safeguards which anticipate dangerous consequences of failures, monitor failures and their consequences, lessen the likelihood of failures that might cause harm and take appropriate remedial actions. Buyer will fully indemnify TI and its representatives against any damages arising out of the use of any TI components in safety-critical applications.

In some cases, TI components may be promoted specifically to facilitate safety-related applications. With such components, TI's goal is to help enable customers to design and create their own end-product solutions that meet applicable functional safety standards and requirements. Nonetheless, such components are subject to these terms.

No TI components are authorized for use in FDA Class III (or similar life-critical medical equipment) unless authorized officers of the parties have executed a special agreement specifically governing such use.

Only those TI components which TI has specifically designated as military grade or "enhanced plastic" are designed and intended for use in military/aerospace applications or environments. Buyer acknowledges and agrees that any military or aerospace use of TI components which have **not** been so designated is solely at the Buyer's risk, and that Buyer is solely responsible for compliance with all legal and regulatory requirements in connection with such use.

TI has specifically designated certain components as meeting ISO/TS16949 requirements, mainly for automotive use. In any case of use of non-designated products, TI will not be responsible for any failure to meet ISO/TS16949.

Products

Audio	www.ti.com/audio
Amplifiers	amplifier.ti.com
Data Converters	dataconverter.ti.com
DLP® Products	www.dlp.com
DSP	dsp.ti.com
Clocks and Timers	www.ti.com/clocks
Interface	interface.ti.com
Logic	logic.ti.com
Power Mgmt	power.ti.com
Microcontrollers	microcontroller.ti.com
RFID	www.ti-rfid.com
OMAP Applications Processors	www.ti.com/omap
Wireless Connectivity	www.ti.com/wirelessconnectivity

Applications

Automotive and Transportation	www.ti.com/automotive
Communications and Telecom	www.ti.com/communications
Computers and Peripherals	www.ti.com/computers
Consumer Electronics	www.ti.com/consumer-apps
Energy and Lighting	www.ti.com/energy
Industrial	www.ti.com/industrial
Medical	www.ti.com/medical
Security	www.ti.com/security
Space, Avionics and Defense	www.ti.com/space-avionics-defense
Video and Imaging	www.ti.com/video

TI E2E Community

e2e.ti.com