

P-Channel Enhancement Mode Vertical DMOS FETs

Features

- ▶ Low threshold
- ▶ High input impedance
- ▶ Low input capacitance
- ▶ Fast switching speeds
- ▶ Low on-resistance
- ▶ Free from secondary breakdown
- ▶ Low input and output leakage

Applications

- ▶ Logic level interfaces
- ▶ Solid state relays
- ▶ Linear amplifiers
- ▶ Power management
- ▶ Analog switches
- ▶ Telecom switches

General Description

This low threshold enhancement-mode (normally-off) transistor utilizes a vertical DMOS structure and Supertex's well-proven silicon-gate manufacturing process. This combination produces a device with the power handling capabilities of bipolar transistors and with the high input impedance and positive temperature coefficient inherent in MOS devices. Characteristic of all MOS structures, this device is free from thermal runaway and thermally-induced secondary breakdown.

Supertex's vertical DMOS FETs are ideally suited to a wide range of switching and amplifying applications where very low threshold voltage, high breakdown voltage, high input impedance, low input capacitance, and fast switching speeds are desired.

Ordering Information

Device	Package Option	BV_{DSS}/BV_{DGS} (V)	$R_{DS(ON)}$ (max) (Ω)	$V_{GS(th)}$ (max) (V)	$I_{D(ON)}$ (min) (mA)
	TO-243AA (SOT-89)				
TP2435	TP2435N8-G	-350	15	-2.4	-800

-G indicates package is RoHS compliant ("Green")



Absolute Maximum Ratings

Parameter	Value
Drain-to-source voltage	BV_{DSS}
Drain-to-gate voltage	BV_{DGS}
Gate-to-source voltage	$\pm 20V$
Operating and storage temperature	$-55^{\circ}C$ to $+150^{\circ}C$
Soldering temperature*	$300^{\circ}C$

Absolute Maximum Ratings are those values beyond which damage to the device may occur. Functional operation under these conditions is not implied. Continuous operation of the device at the absolute rating level may affect device reliability. All voltages are referenced to device ground.

* Distance of 1.6 mm from case for 10 seconds.

Pin Configuration

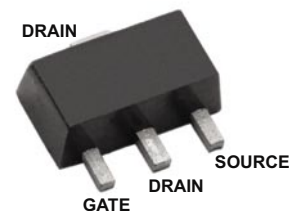

TO-243AA (SOT-89) (N8)

Product Marking

TP4SW W = Code for week sealed
 _____ = "Green" Packaging

Package may or may not include the following marks: Si or

TO-243AA (SOT-89) (N8)

Thermal Characteristics

Package	I_D (continuous) [†] (mA)	I_D (pulsed) (A)	Power Dissipation @ $T_A = 25^\circ\text{C}$ (W)	θ_{jc} ($^\circ\text{C}/\text{W}$)	θ_{ja} ($^\circ\text{C}/\text{W}$)	I_{DR} [‡] (mA)	I_{DRM} (A)
TO-243AA (SOT-89)	-231	-1.1	1.6	15	78 [‡]	-231	-1.1

[†] I_D (continuous) is limited by max rated T_J .
[‡] Mounted on FR5 board, 25mm x 25mm x 1.57mm.

Electrical Characteristics ($T_A = 25^\circ\text{C}$ unless otherwise specified)

Sym	Parameter	Min	Typ	Max	Units	Conditions
BV_{DSS}	Drain-to-source breakdown voltage	-350	-	-	V	$V_{GS} = 0\text{V}, I_D = -250\mu\text{A}$
$V_{GS(th)}$	Gate threshold voltage	-1.0	-	-2.4	V	$V_{GS} = V_{DS}, I_D = -1.0\text{mA}$
$\Delta V_{GS(th)}$	Change in $V_{GS(th)}$ with temperature	-	-	4.5	mV/ $^\circ\text{C}$	$V_{GS} = V_{DS}, I_D = -1.0\text{mA}$
I_{GSS}	Gate body leakage	-	-	-100	nA	$V_{GS} = \pm 20\text{V}, V_{DS} = 0\text{V}$
I_{DSS}	Zero gate voltage drain current	-	-	-10	μA	$V_{GS} = 0\text{V}, V_{DS} = \text{Max Rating}$
		-	-	-1.0	mA	$V_{DS} = 0.8 \text{ Max Rating}, V_{GS} = 0\text{V}, T_A = 125^\circ\text{C}$
$I_{D(ON)}$	On-state drain current	-0.3	-	-	A	$V_{GS} = -4.5\text{V}, V_{DS} = -25\text{V}$
		-0.8	-	-		$V_{GS} = -10\text{V}, V_{DS} = -25\text{V}$
$R_{DS(ON)}$	Static drain-to-source on-state resistance	-	-	15	Ω	$V_{GS} = -3.0\text{V}, I_D = -20\text{mA}$
		-	-	15		$V_{GS} = -4.5\text{V}, I_D = -150\text{mA}$
		-	-	15		$V_{GS} = -10\text{V}, I_D = -500\text{mA}$
$\Delta R_{DS(ON)}$	Change in $R_{DS(ON)}$ with temperature	-	-	1.7	%/ $^\circ\text{C}$	$V_{GS} = -10\text{V}, I_D = -150\text{mA}$
G_{FS}	Forward transconductance	125	-	-	mmho	$V_{DS} = -25\text{V}, I_D = -350\text{mA}$
C_{ISS}	Input capacitance	-	-	200	pF	$V_{GS} = 0\text{V}, V_{DS} = -25\text{V}, f = 1.0 \text{ MHz}$
C_{OSS}	Common source output capacitance	-	-	70		
C_{RSS}	Reverse transfer capacitance	-	-	25		
$t_{d(ON)}$	Turn-on delay time	-	-	15	ns	$V_{DD} = -25\text{V}, I_D = -250\text{mA}, R_{GEN} = 25\Omega$
t_r	Rise time	-	-	20		
$t_{d(OFF)}$	Turn-off delay time	-	-	25		
t_f	Fall time	-	-	50		
V_{SD}	Diode forward voltage drop	-	-	-1.5	V	$V_{GS} = 0\text{V}, I_{SD} = -750\text{mA}$
t_{rr}	Reverse recovery time	-	300	-	ns	$V_{GS} = 0\text{V}, I_{SD} = -750\text{mA}$

Notes:

- All D.C. parameters 100% tested at 25°C unless otherwise stated. (Pulse test: 300 μs pulse, 2% duty cycle.)
- All A.C. parameters sample tested.

Switching Waveforms and Test Circuit

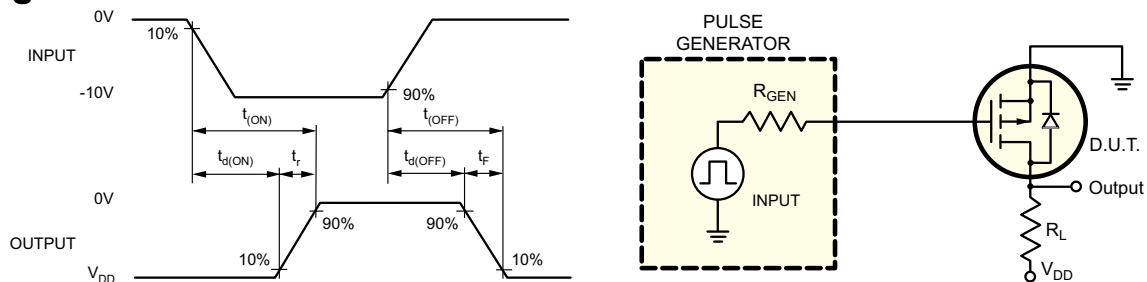

Typical Performance Curves

Output Characteristics

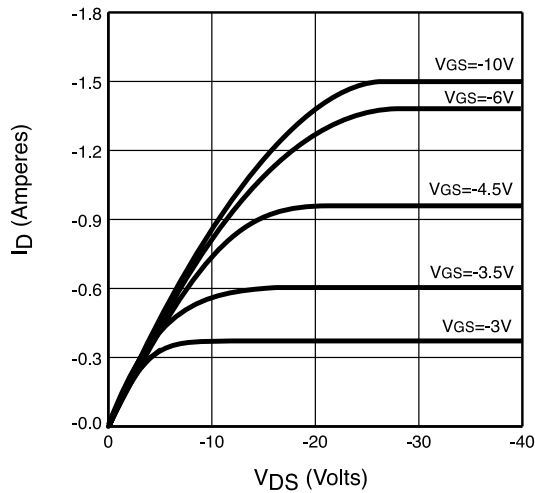

Saturation Characteristics

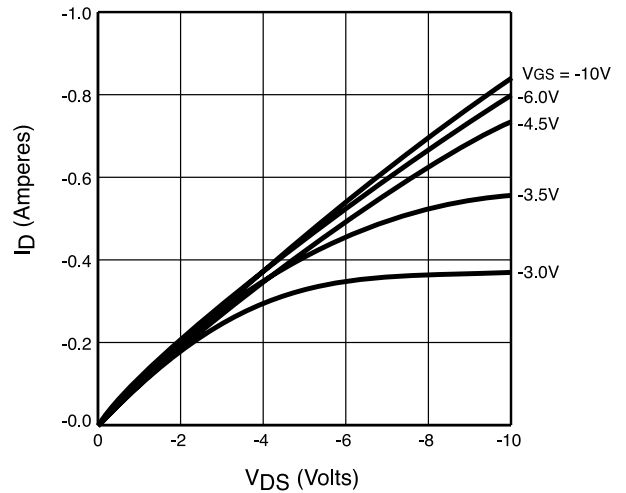

Transconductance vs. Drain Current

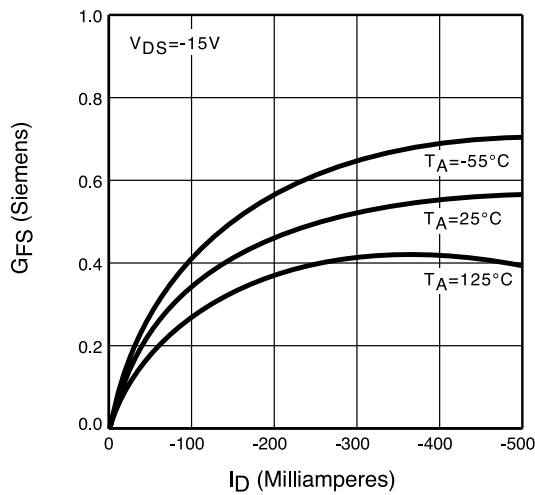

Power Dissipation vs. Ambient Temperature

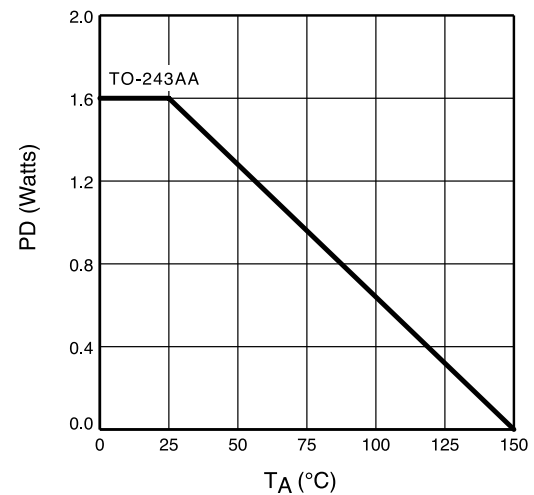

Maximum Rated Safe Operating Area

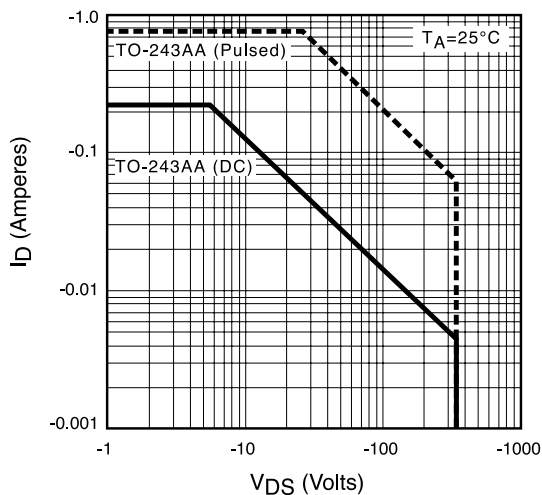

Thermal Response Characteristics

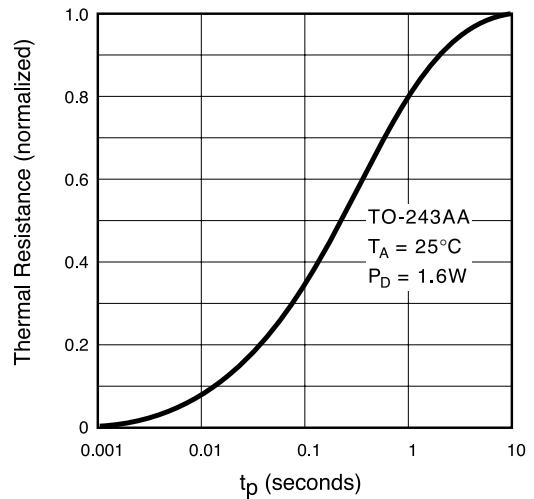

Typical Performance Curves (cont.)

BV_{DSS} Variation with Temperature

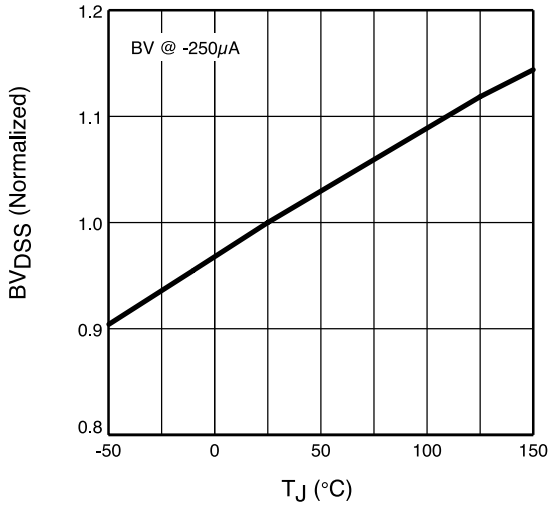

On Resistance vs. Drain Current

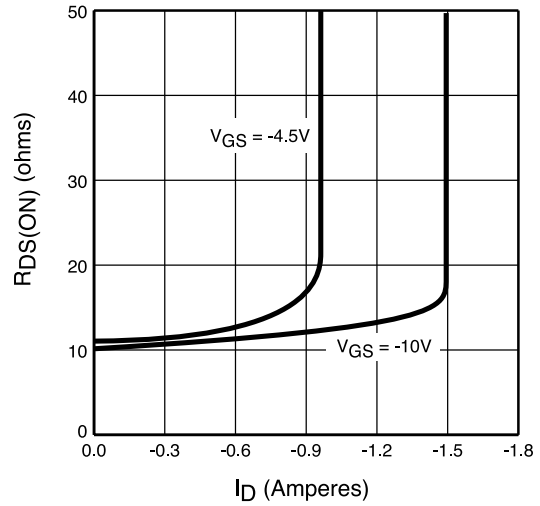

Transfer Characteristics

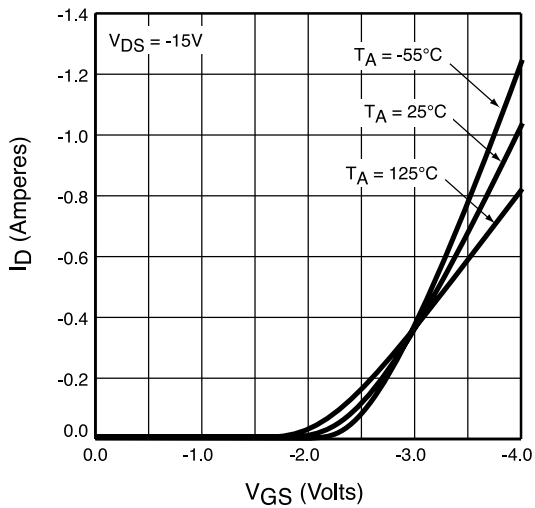

V_{GS(TH)} and R_{DS(ON)} w/ Temperature

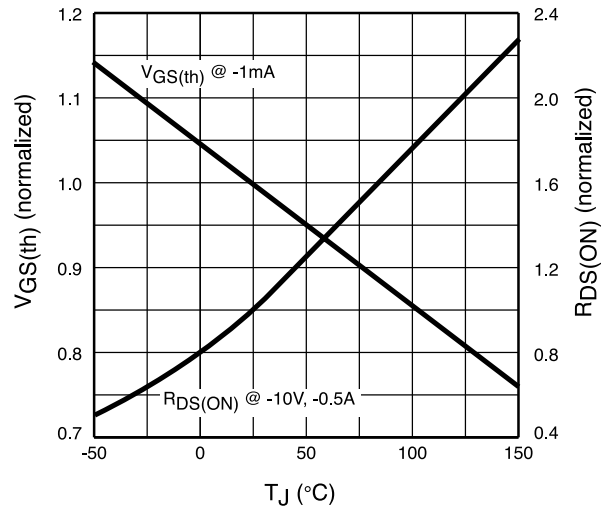

Capacitance vs. Drain Source Voltage

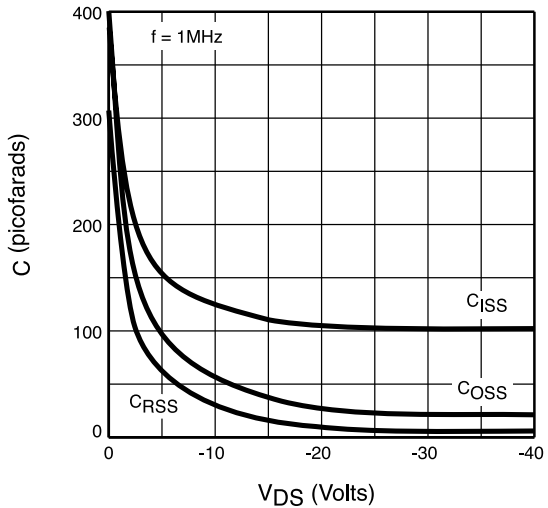

Gate Drive Dynamic Characteristics

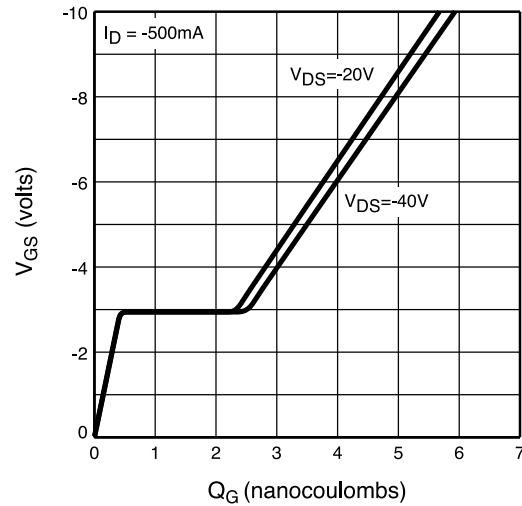

3-Lead TO-243AA (SOT-89) Package Outline (N8)

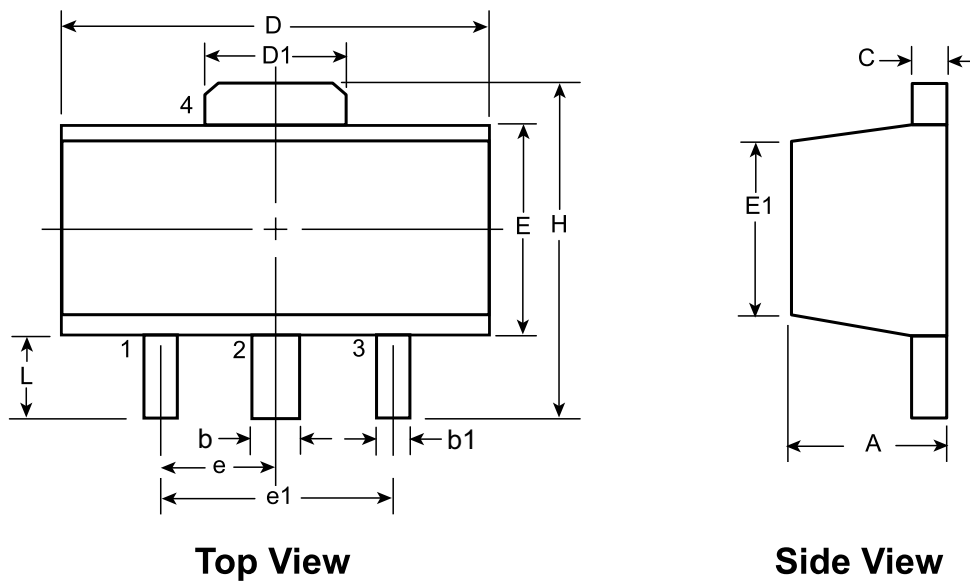

Top View

Side View

Symbol		A	b	b1	C	D	D1	E	E1	e	e1	H	L
Dimensions (mm)	MIN	1.40	0.44	0.36	0.35	4.40	1.62	2.29	2.13	1.50 BSC	3.00 BSC	3.94	0.89
	NOM	-	-	-	-	-	-	-	-			-	-
	MAX	1.60	0.56	0.48	0.44	4.60	1.83	2.60	2.29			4.25	1.20

JEDEC Registration TO-243, Variation AA, Issue C, July 1986.

Drawings not to scale.

Supertex Doc. #: DSPD-3TO243AAN8, Version D070908.

Supertex inc. does not recommend the use of its products in life support applications, and will not knowingly sell them for use in such applications unless it receives an adequate "product liability indemnification insurance agreement." Supertex inc. does not assume responsibility for use of devices described, and limits its liability to the replacement of the devices determined defective due to workmanship. No responsibility is assumed for possible omissions and inaccuracies. Circuitry and specifications are subject to change without notice. For the latest product specifications refer to the Supertex inc. website: <http://www.supertex.com>.