

High Efficiency LED, Ø 5 mm Untinted Non-Diffused

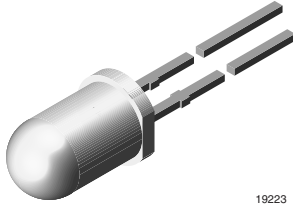

19223

DESCRIPTION

The TLH.5800 series was developed for standard applications which need a very small radiation angle or a very high luminous intensity.

It is housed in a 5 mm untinted non-diffused plastic package. The very small viewing angle of these devices provide a very high luminous intensity.

The yellow and green LEDs are categorized in luminous intensity and additionally in wavelength groups.

That allows users to assemble LEDs with uniform appearance.

FEATURES

- Standard T-1 $\frac{3}{4}$ package
- Small mechanical tolerances
- Suitable for DC and high peak current
- Very small viewing angle
- Very high intensity
- Luminous intensity categorized
- Yellow and green color categorized
- ESD-withstand voltage up to 2 kV according to JESD22-A114-B
- Compliant to RoHS directive 2002/95/EC and in accordance to WEEE 2002/96/EC

RoHS
COMPLIANT

APPLICATIONS

- Status lights
- Off/on indicator
- Lightpipe
- Outdoor display
- Medical instruments
- Maintenance lights
- Legend lights

PRODUCT GROUP AND PACKAGE DATA

- Product group: LED
- Package: 5 mm
- Product series: standard
- Angle of half intensity: $\pm 4^\circ$

PARTS TABLE

PART	COLOR, LUMINOUS INTENSITY	TECHNOLOGY
TLHY5800	Yellow, $I_V > 100$ mcd	GaAsP on GaP
TLHG5800	Green, $I_V > 430$ mcd	GaP on GaP
TLHP5800	Pure green, $I_V > 25$ mcd	GaP on GaP

ABSOLUTE MAXIMUM RATINGS ¹⁾ TLHY5800 , TLHG5800, TLHP5800

PARAMETER	TEST CONDITION	SYMBOL	VALUE	UNIT
Reverse voltage		V_R	6	V
DC Forward current	$T_{amb} \leq 65^\circ\text{C}$	I_F	30	mA
Surge forward current	$t_p \leq 10 \mu\text{s}$	I_{FSM}	1	A
Power dissipation	$T_{amb} \leq 65^\circ\text{C}$	P_V	100	mW
Junction temperature		T_j	100	$^\circ\text{C}$
Operating temperature range		T_{amb}	- 40 to + 100	$^\circ\text{C}$
Storage temperature range		T_{stg}	- 55 to + 100	$^\circ\text{C}$
Soldering temperature	$t \leq 5$ s, 2 mm from body	T_{sd}	260	$^\circ\text{C}$
Thermal resistance junction/ambient		R_{thJA}	350	K/W

Note:

¹⁾ $T_{amb} = 25^\circ\text{C}$ unless otherwise specified

OPTICAL AND ELECTRICAL CHARACTERISTICS ¹⁾ TLHY5800, YELLOW						
PARAMETER	TEST CONDITION	SYMBOL	MIN.	TYP.	MAX.	UNIT
Luminous intensity ²⁾	I _F = 20 mA	I _V	100	250		mcd
Dominant wavelength	I _F = 10 mA	λ _d	581		594	nm
Peak wavelength	I _F = 10 mA	λ _p		585		nm
Angle of half intensity	I _F = 10 mA	φ		± 4		deg
Forward voltage	I _F = 20 mA	V _F		2.4	3	V
Reverse voltage	I _R = 10 μA	V _R	6	15		V
Junction capacitance	V _R = 0, f = 1 MHz	C _j		50		pF

Note:

¹⁾ T_{amb} = 25 °C unless otherwise specified

²⁾ In one packing unit I_{Vmin.}/I_{Vmax.} ≤ 0.5

OPTICAL AND ELECTRICAL CHARACTERISTICS ¹⁾ TLHG5800, GREEN						
PARAMETER	TEST CONDITION	SYMBOL	MIN.	TYP.	MAX.	UNIT
Luminous intensity ²⁾	I _F = 20 mA	I _V	430	700		mcd
Dominant wavelength	I _F = 10 mA	λ _d	562		575	nm
Peak wavelength	I _F = 10 mA	λ _p		565		nm
Angle of half intensity	I _F = 10 mA	φ		± 4		deg
Forward voltage	I _F = 20 mA	V _F		2.4	3	V
Reverse voltage	I _R = 10 μA	V _R	6	15		V
Junction capacitance	V _R = 0, f = 1 MHz	C _j		50		pF

Note:

¹⁾ T_{amb} = 25 °C unless otherwise specified

²⁾ In one packing unit I_{Vmin.}/I_{Vmax.} ≤ 0.5

OPTICAL AND ELECTRICAL CHARACTERISTICS ¹⁾ TLHP5800, PURE GREEN						
PARAMETER	TEST CONDITION	SYMBOL	MIN.	TYP.	MAX.	UNIT
Luminous intensity ²⁾	I _F = 20 mA	I _V	25	85		mcd
Dominant wavelength	I _F = 10 mA	λ _d	555		565	nm
Peak wavelength	I _F = 10 mA	λ _p		555		nm
Angle of half intensity	I _F = 10 mA	φ		± 4		deg
Forward voltage	I _F = 20 mA	V _F		2.4	3	V
Reverse voltage	I _R = 10 μA	V _R	6	15		V
Junction capacitance	V _R = 0, f = 1 MHz	C _j		50		pF

Note:

¹⁾ T_{amb} = 25 °C unless otherwise specified

²⁾ In one packing unit I_{Vmin.}/I_{Vmax.} ≤ 0.5

LUMINOUS INTENSITY CLASSIFICATION			
GROUP	LIGHT INTENSITY (mcd)		
	STANDARD	MIN.	MAX.
BB		430	860
CC		575	1150
DD		750	1500
EE		1000	2000
FF		1350	2700

Note:

Luminous intensity is tested at a current pulse duration of 25 ms and an accuracy of ± 11 %.

The above type numbers represent the order groups which include only a few brightness groups. Only one group will be shipped on each bag (there will be no mixing of two groups on each bag).

In order to ensure availability, single brightness groups will not be orderable.

In a similar manner for colors where wavelength groups are measured and binned, single wavelength groups will be shipped in any one bag.

In order to ensure availability, single wavelength groups will not be orderable.

TYPICAL CHARACTERISTICS

$T_{amb} = 25\text{ }^{\circ}\text{C}$, unless otherwise specified

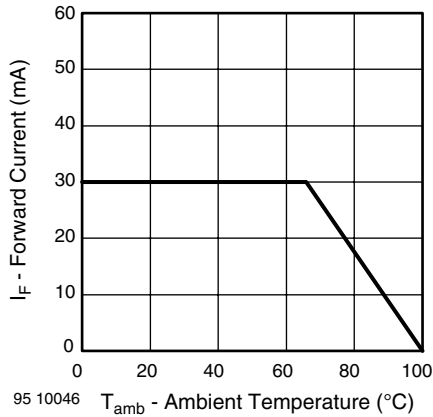

Figure 1. Forward Current vs. Ambient Temperature

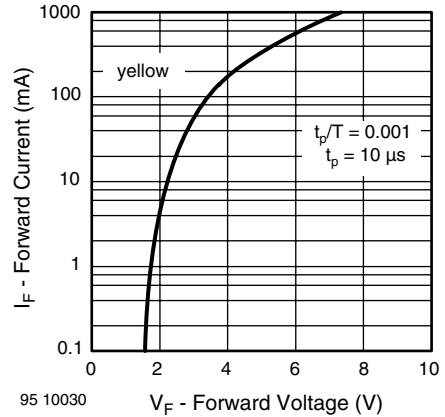

Figure 4. Forward Current vs. Forward Voltage

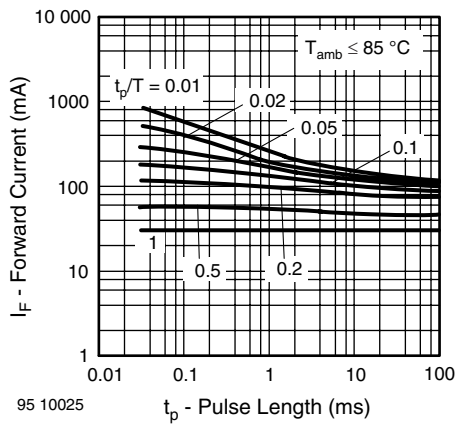

Figure 2. Forward Current vs. Pulse Length

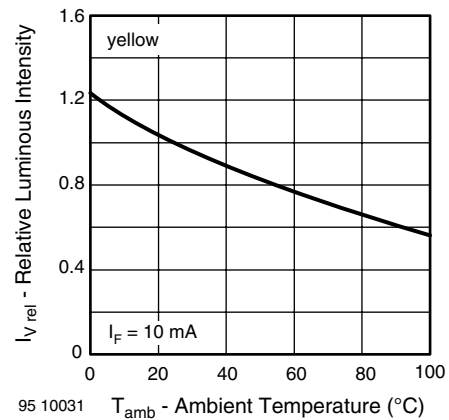

Figure 5. Rel. Luminous Intensity vs. Ambient Temperature

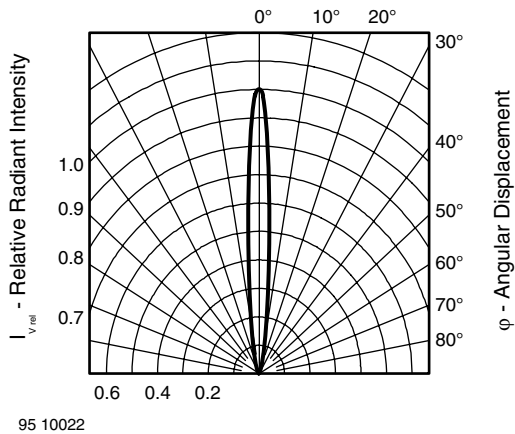

Figure 3. Rel. Luminous Intensity vs. Angular Displacement

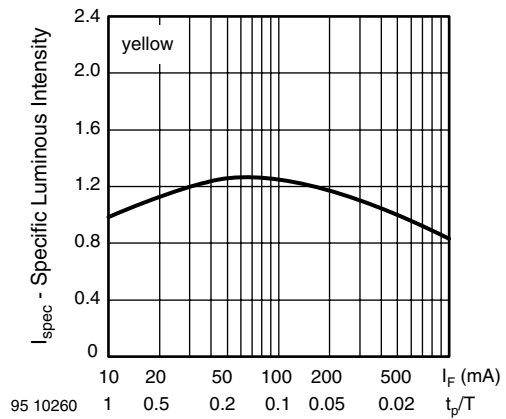

Figure 6. Rel. Lumin. Intensity vs. Forw. Current/Duty Cycle

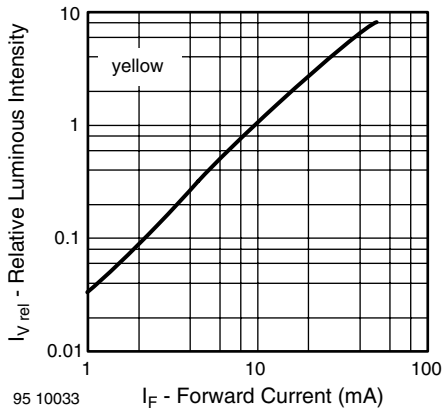

Figure 7. Relative Luminous Intensity vs. Forward Current

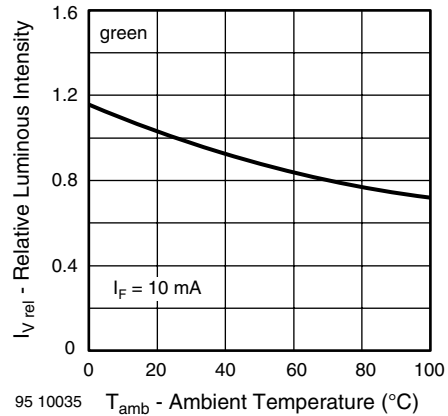

Figure 10. Rel. Luminous Intensity vs. Ambient Temperature

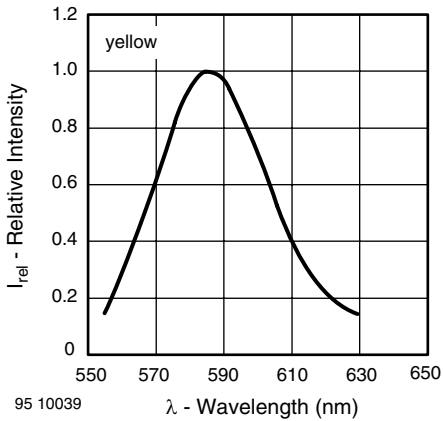

Figure 8. Relative Intensity vs. Wavelength

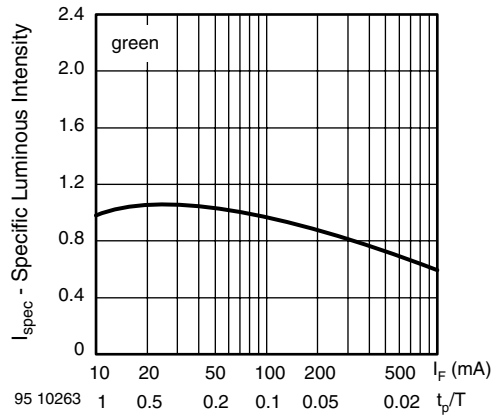

Figure 11. Specific Luminous Intensity vs. Forward Current

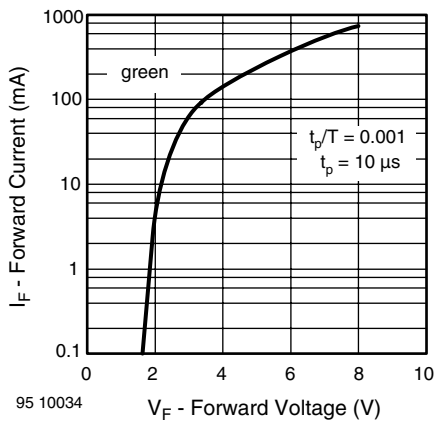

Figure 9. Forward Current vs. Forward Voltage

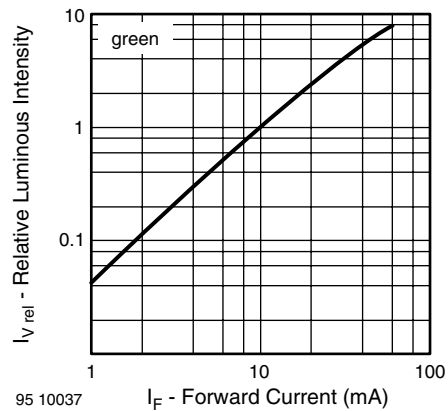

Figure 12. Relative Luminous Intensity vs. Forward Current

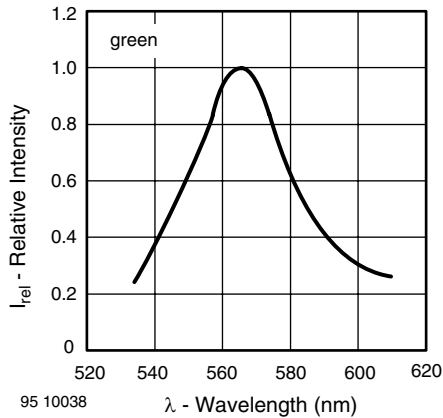

Figure 13. Relative Intensity vs. Wavelength

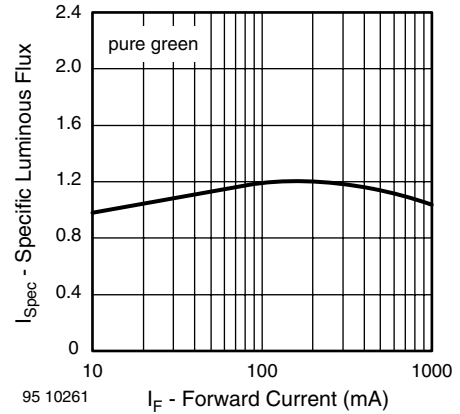

Figure 16. Specific Luminous Intensity vs. Forward Current

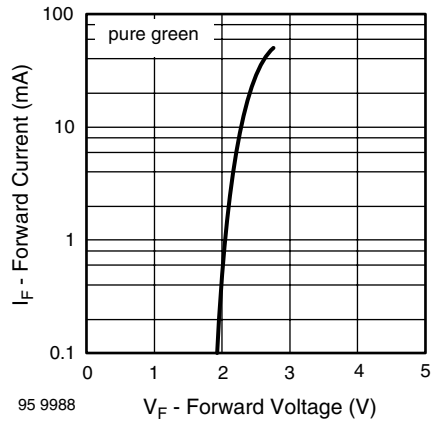

Figure 14. Forward Current vs. Forward Voltage

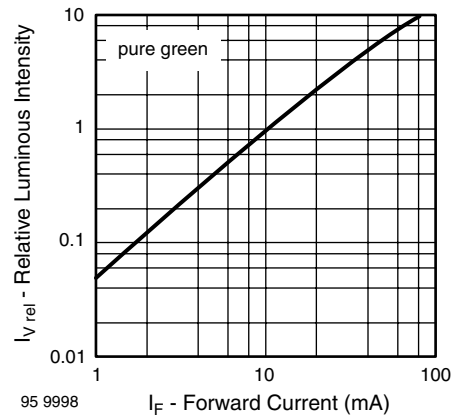

Figure 17. Relative Luminous Intensity vs. Forward Current

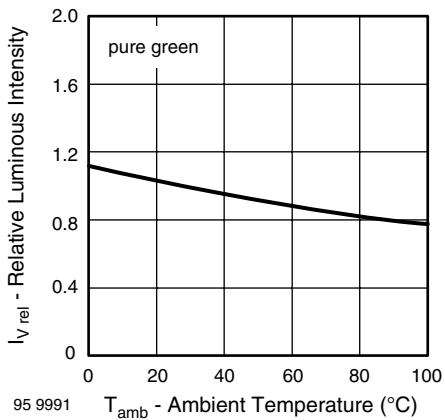

Figure 15. Rel. Luminous Intensity vs. Ambient Temperature

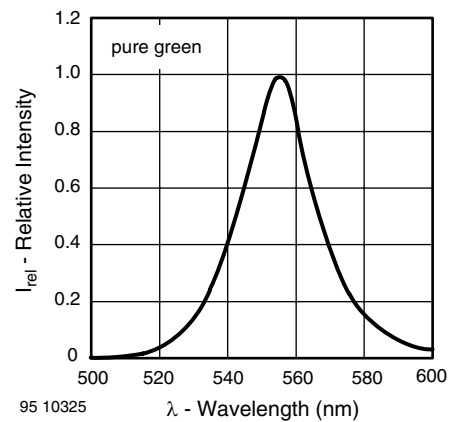
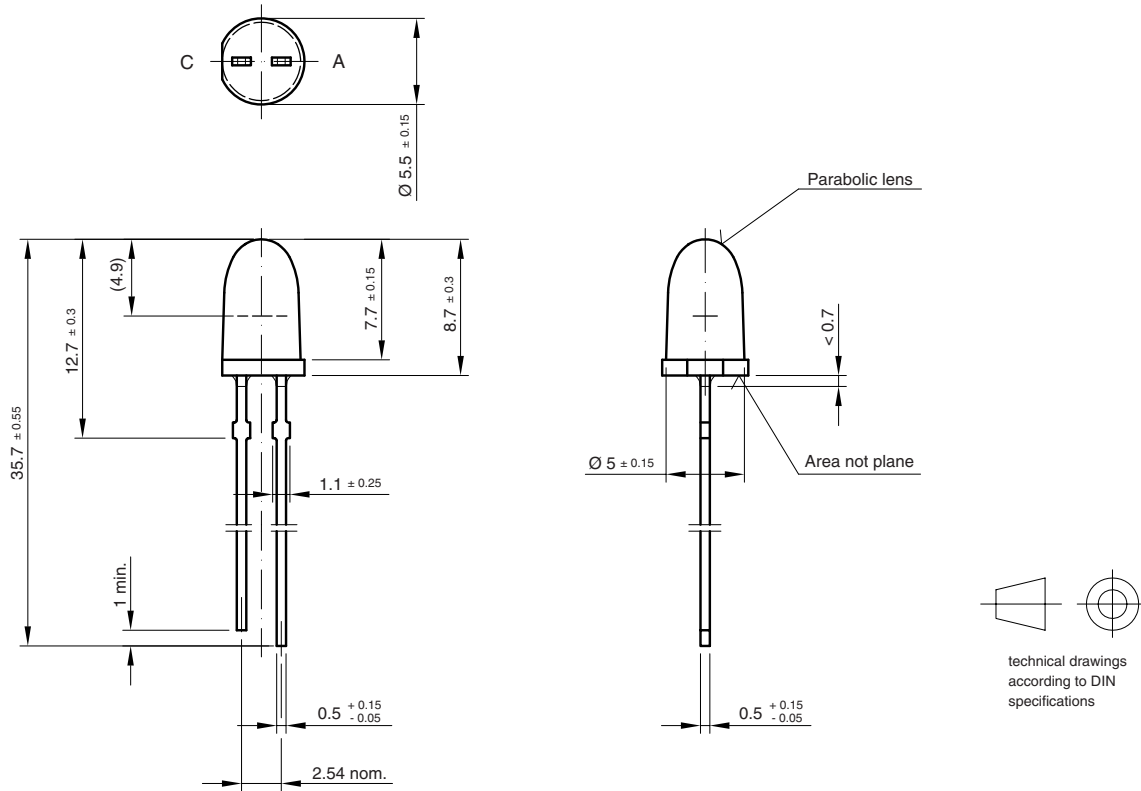

Figure 18. Relative Intensity vs. Wavelength

PACKAGE DIMENSIONS in millimeters



Drawing-No.: 6.544-5310.01-4
Issue: 4; 19.05.09
95 11476



Disclaimer

ALL PRODUCT, PRODUCT SPECIFICATIONS AND DATA ARE SUBJECT TO CHANGE WITHOUT NOTICE TO IMPROVE RELIABILITY, FUNCTION OR DESIGN OR OTHERWISE.

Vishay Intertechnology, Inc., its affiliates, agents, and employees, and all persons acting on its or their behalf (collectively, "Vishay"), disclaim any and all liability for any errors, inaccuracies or incompleteness contained in any datasheet or in any other disclosure relating to any product.

Vishay makes no warranty, representation or guarantee regarding the suitability of the products for any particular purpose or the continuing production of any product. To the maximum extent permitted by applicable law, Vishay disclaims (i) any and all liability arising out of the application or use of any product, (ii) any and all liability, including without limitation special, consequential or incidental damages, and (iii) any and all implied warranties, including warranties of fitness for particular purpose, non-infringement and merchantability.

Statements regarding the suitability of products for certain types of applications are based on Vishay's knowledge of typical requirements that are often placed on Vishay products in generic applications. Such statements are not binding statements about the suitability of products for a particular application. It is the customer's responsibility to validate that a particular product with the properties described in the product specification is suitable for use in a particular application. Parameters provided in datasheets and/or specifications may vary in different applications and performance may vary over time. All operating parameters, including typical parameters, must be validated for each customer application by the customer's technical experts. Product specifications do not expand or otherwise modify Vishay's terms and conditions of purchase, including but not limited to the warranty expressed therein.

Except as expressly indicated in writing, Vishay products are not designed for use in medical, life-saving, or life-sustaining applications or for any other application in which the failure of the Vishay product could result in personal injury or death. Customers using or selling Vishay products not expressly indicated for use in such applications do so at their own risk. Please contact authorized Vishay personnel to obtain written terms and conditions regarding products designed for such applications.

No license, express or implied, by estoppel or otherwise, to any intellectual property rights is granted by this document or by any conduct of Vishay. Product names and markings noted herein may be trademarks of their respective owners.

Material Category Policy

Vishay Intertechnology, Inc. hereby certifies that all its products that are identified as RoHS-Compliant fulfill the definitions and restrictions defined under Directive 2011/65/EU of The European Parliament and of the Council of June 8, 2011 on the restriction of the use of certain hazardous substances in electrical and electronic equipment (EEE) - recast, unless otherwise specified as non-compliant.

Please note that some Vishay documentation may still make reference to RoHS Directive 2002/95/EC. We confirm that all the products identified as being compliant to Directive 2002/95/EC conform to Directive 2011/65/EU.

Vishay Intertechnology, Inc. hereby certifies that all its products that are identified as Halogen-Free follow Halogen-Free requirements as per JEDEC JS709A standards. Please note that some Vishay documentation may still make reference to the IEC 61249-2-21 definition. We confirm that all the products identified as being compliant to IEC 61249-2-21 conform to JEDEC JS709A standards.