



# TAOGLAS®



# Datasheet

## Taoglas Invisible Antenna™

**Part No:**  
TFX257.A

### Description

TFX257.A - Wi-Fi Transparent Antenna

### Features:

Wi-Fi (including Wi-Fi 6) 2.4-2.5, 4.9-5.8, 5.9-7.125GHz  
Transparent – Ultra Low Profile  
Dimensions: 32mm \* 114mm  
Connector: FAKRA Code I (M) Beige  
RoHS & Reach Compliant

<b>1.</b>	<b>Introduction</b>	<b>2</b>
<b>2.</b>	<b>Specification</b>	<b>3</b>
<b>3.</b>	<b>Antenna Characteristics</b>	<b>4</b>
<b>4.</b>	<b>Radiation Patterns</b>	<b>8</b>
<b>5.</b>	<b>Mechanical Drawing</b>	<b>18</b>
<b>6.</b>	<b>Packaging</b>	<b>19</b>
<hr/>		
	Changelog	20

Taoglas makes no warranties based on the accuracy or completeness of the contents of this document and reserves the right to make changes to specifications and product descriptions at any time without notice. Taoglas reserves all rights to this document and the information contained herein. Reproduction, use or disclosure to third parties without express permission is strictly prohibited.



# 1. Introduction



The TFX257 is a first of its kind, invisible antenna designed to cover the entire spectrum of Wi-Fi bands. The TFX257 has been expertly engineered by Taoglas with innovation in mind, the design is based on our excellent design history in pioneering flexible PCB antenna technology. TFX257 is supplied with pre adhered adhesive for ease of installation and has an enclosed carrier terminated with a FAKRA connector.

The invisible flexible antennas are an alternative to standard Flexible PCB antennas where the user may want to install an antenna in a covert area or on a surface, they may want to keep visible. The performance of the antenna is based on the environment where it is placed, care should be taken to mount at least 20mm from metal components where possible.

Typical Applications Include:

- Automotive and Commercial Transportation
- EV Charging and Parking Bays
- Digital Signage and Display screens
- Point Of Sale Kiosks

The installation of the Taoglas Invisible Antenna™ series follows a similar installation method to flexible PCB antennas. Installing a transparent material may show obvious flaws/debris, take care to wipe the area clean before adhering the antenna. The flexible antenna can be disconnected from the body to make installation easier. Where support may be an issue, we would advise using a double-sided adhesive on the housing to ensure the housing body installation does not add any additional pull force to the antenna as this will affect the antennas performance and the adhesive's performance. The feed is not designed to be load bearing and loads of over 0.5Kg can break or damage the feed resulting in the antenna disconnecting.

The TFX257 is connected via a FAKRA Code I male connector for ease of installation. If a custom connector is required, please contact your regional Taoglas customer support team.

## 2. Specification

Electrical								
Band	Frequency (MHz)	Efficiency (%)	Average Gain (dB)	Peak Gain (dBi)	Impedance	Polarization	Radiation Pattern	Max. input power
Wi-Fi 2.4GHz	2400-2500	55.3	-2.58	4.59	50 Ω	Linear	Omni	2W
Wi-Fi 5	5150-5850	41.6	-3.81	3.58				
Wi-Fi 6	5925-7125	31.0	-5.09	2.04				

\*Tested on 4mm Acrylic.

Mechanical	
Dimensions	32 x 114mm
Weight	5g
Material (Housing)	ABS/PC
Material (Antenna)	PET
VLT (Visible Light Transmission)	78.1% TCF (Transparent Conductive Film)
Connector	Code I FAKRA (M) Beige

Environmental	
Operation Temperature	-40°C to 85°C
Storage Temperature	-40°C to 85°C
Relative Humidity	Non-condensing TBD°C TBD% RH

### 3. Antenna Characteristics

#### 3.1 Test Setup

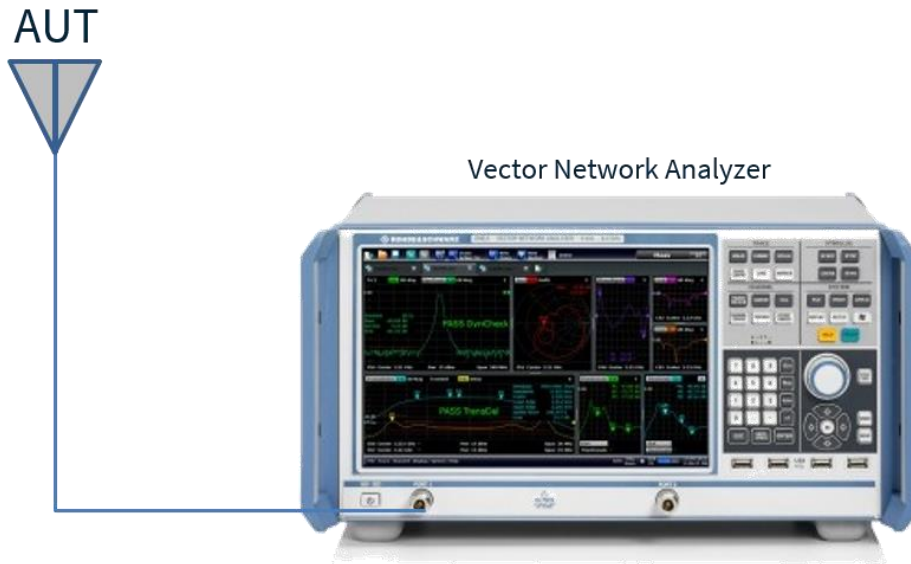

### 3.2 Return Loss

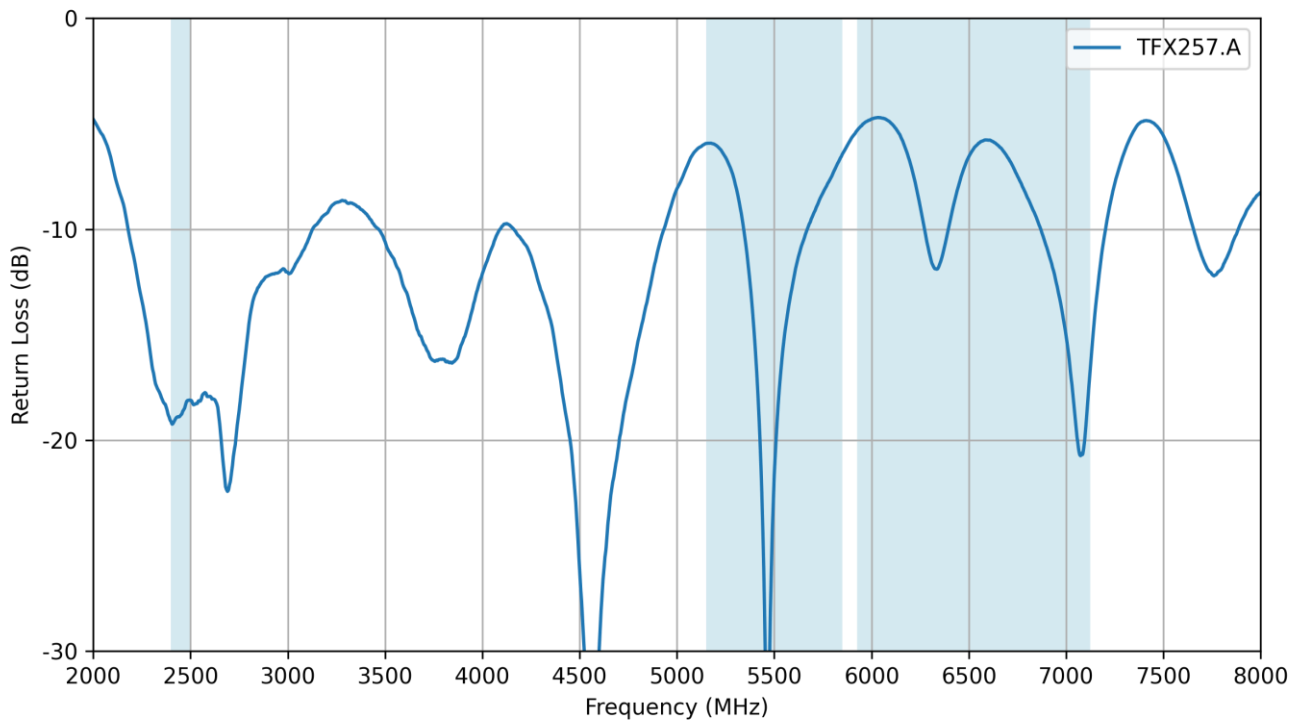

### 3.3 VSWR

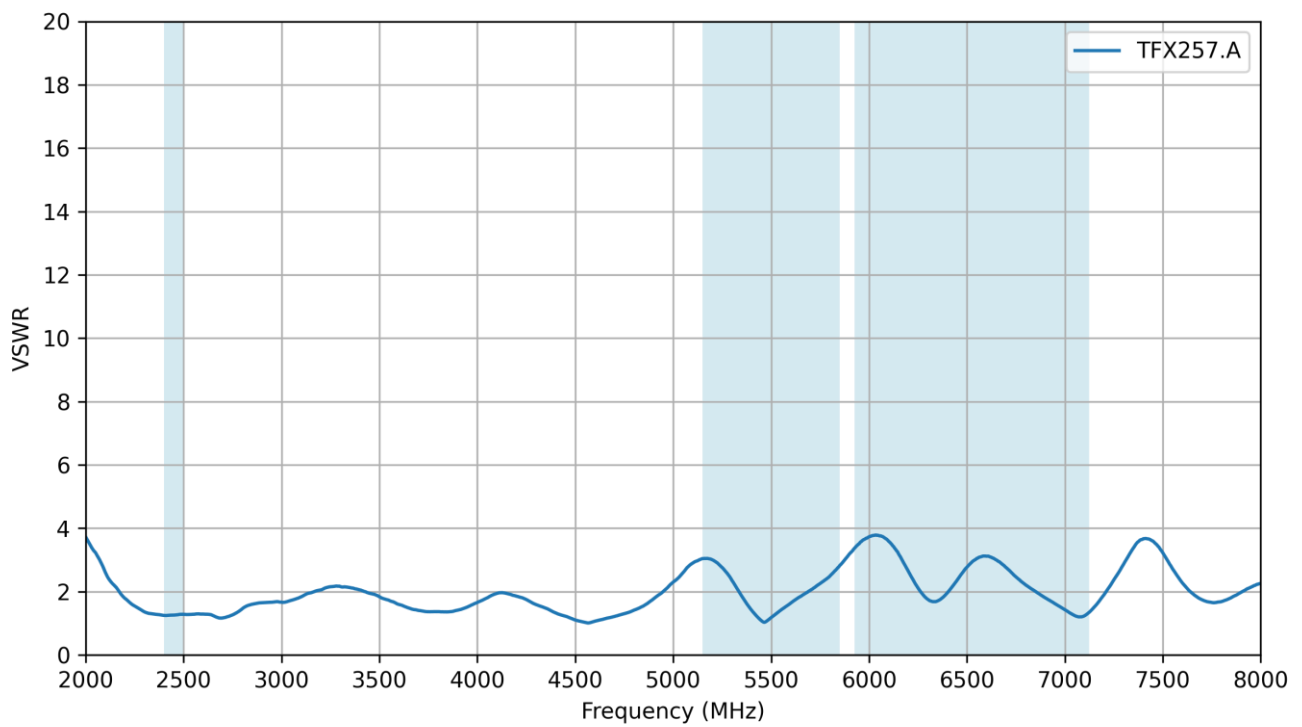

### 3.4 Efficiency

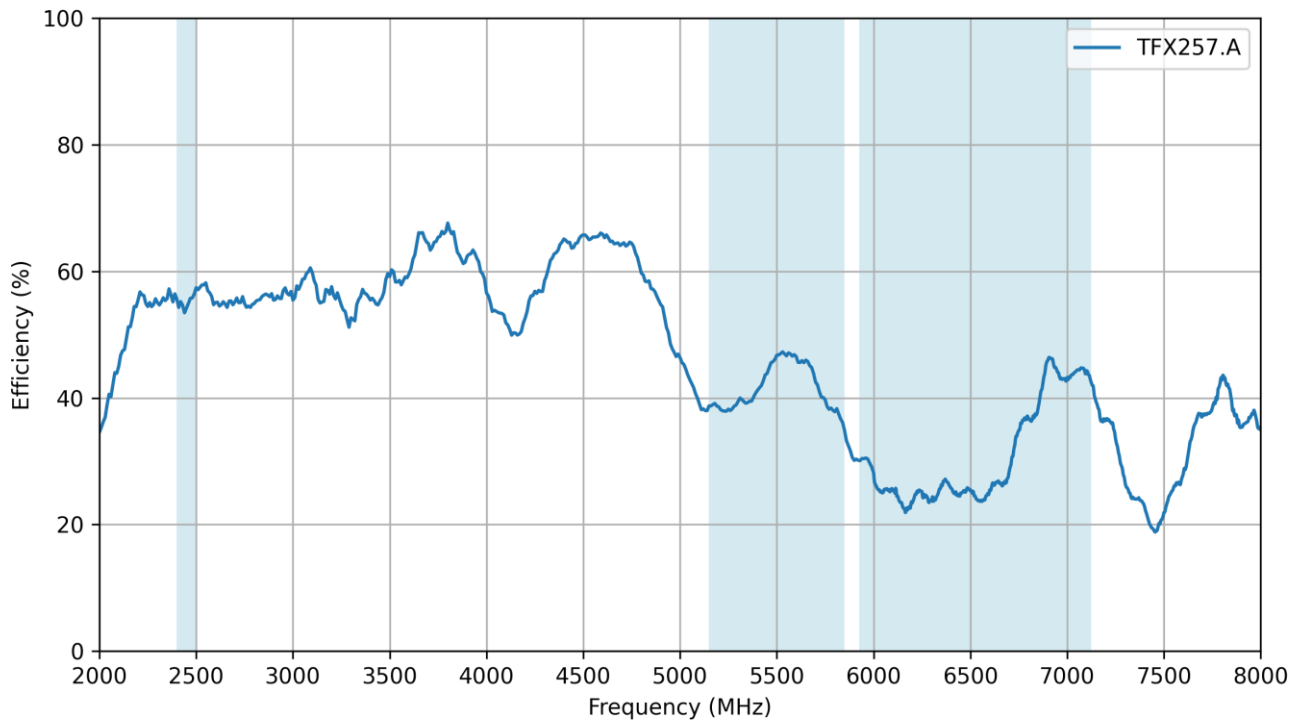

### 3.5 Average Gain

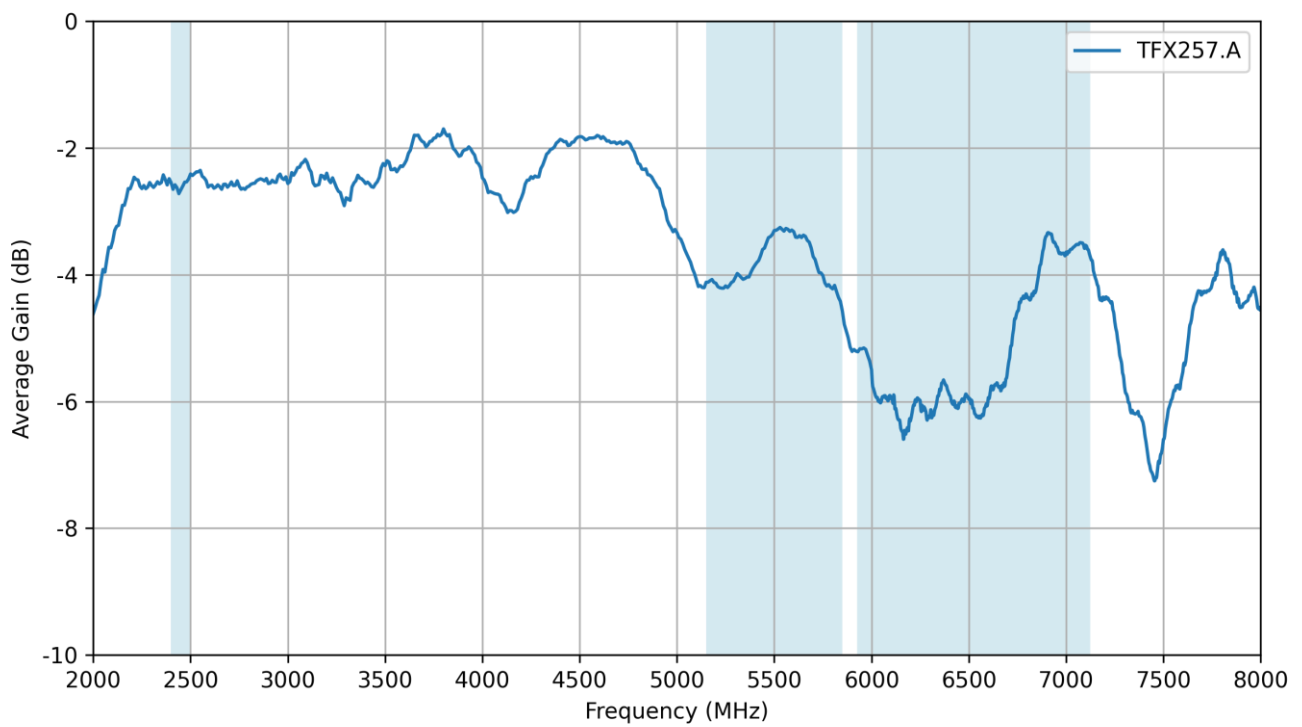

### 3.6 Peak Gain

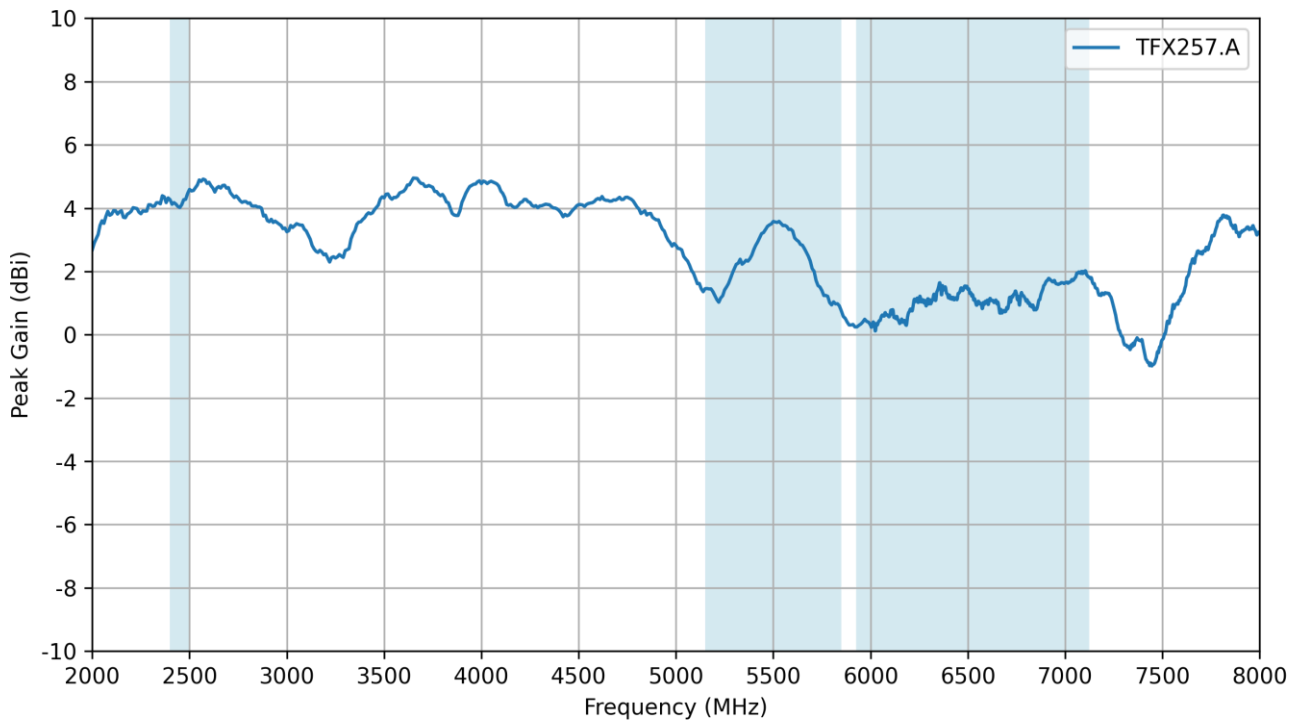

## 4. Radiation Patterns

### 4.1 Test Setup

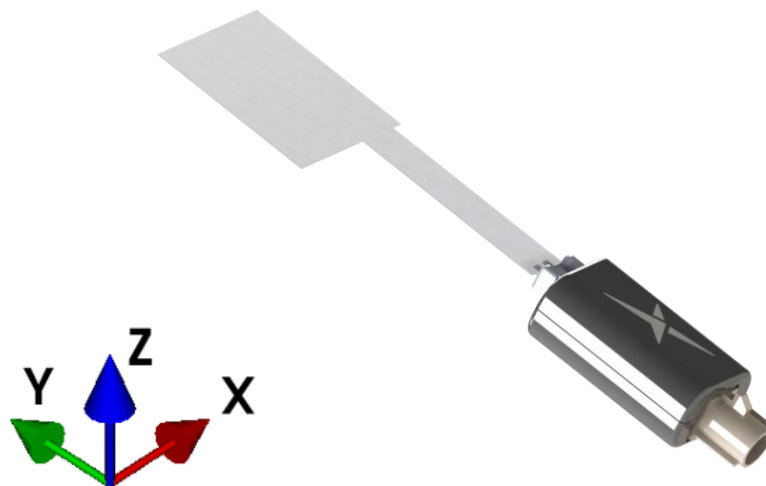
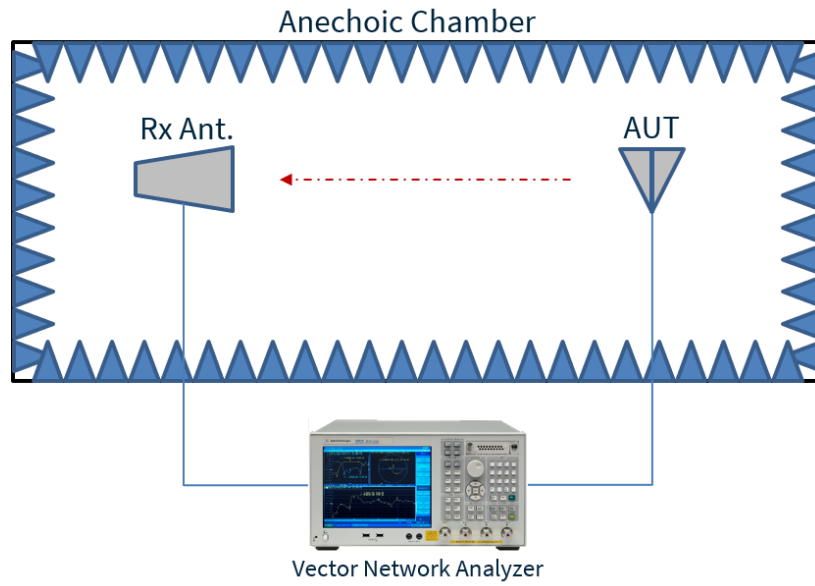

4.2 TFX257.A Patterns at 2400 MHz

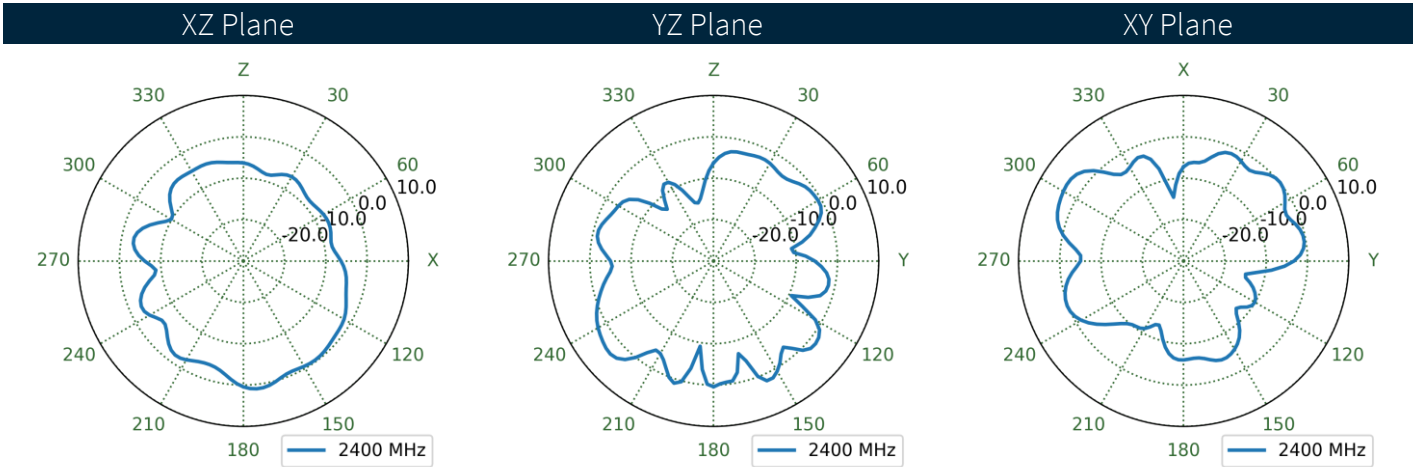
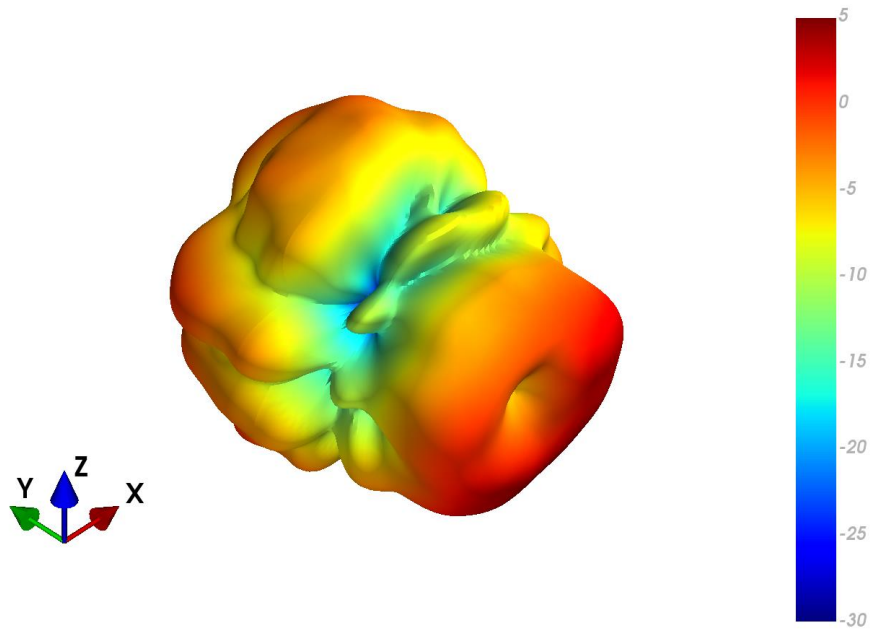

4.3 TFX257.A Patterns at 2450 MHz

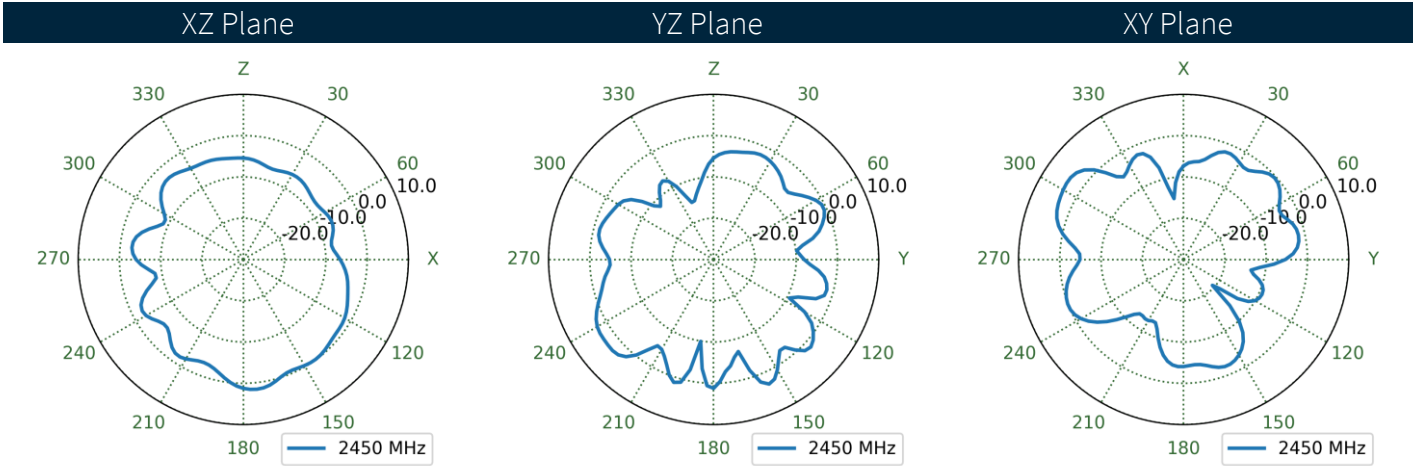
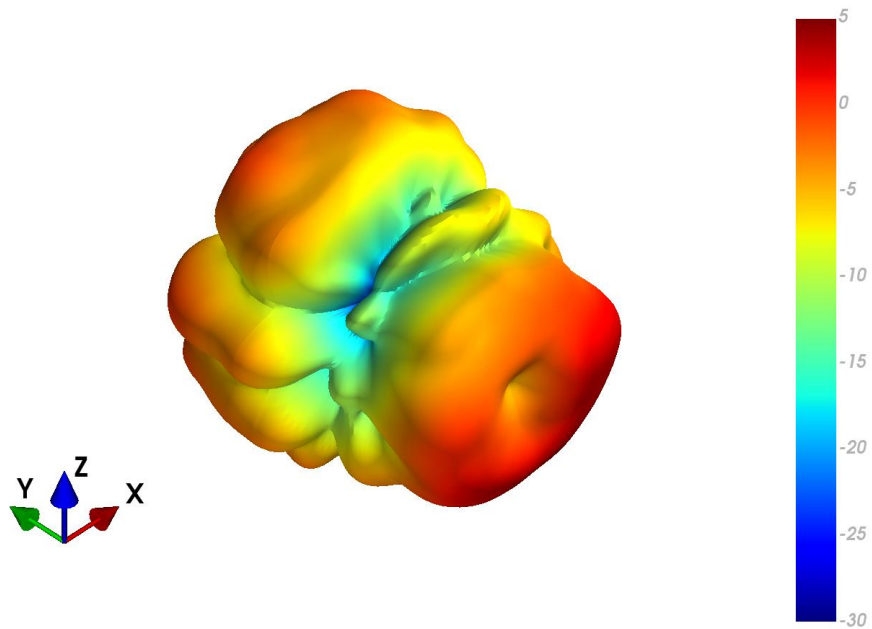

4.4 TFX257.A Patterns at 2500 MHz

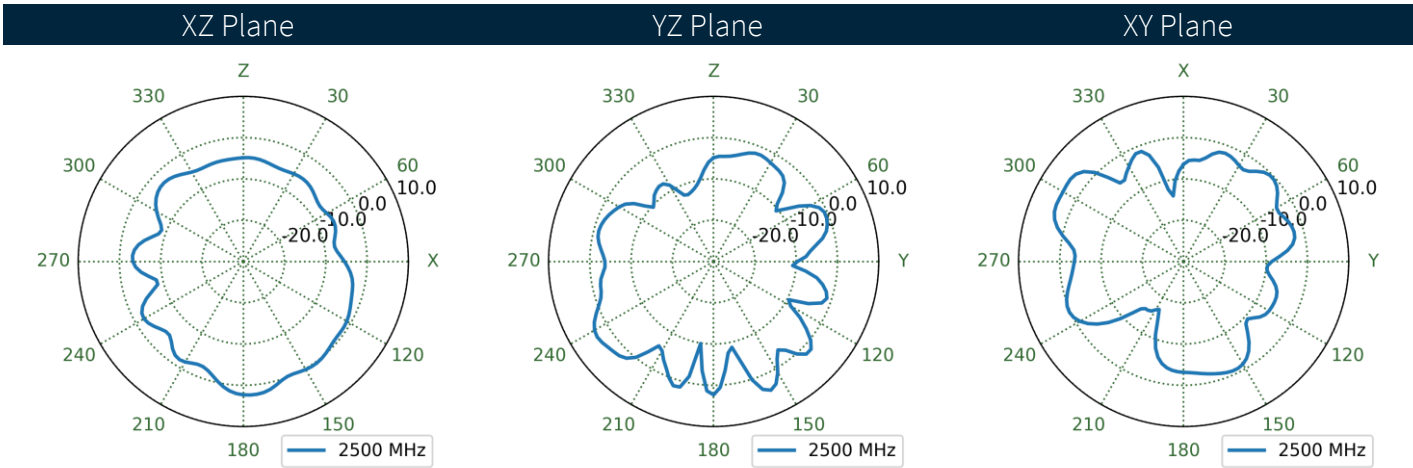
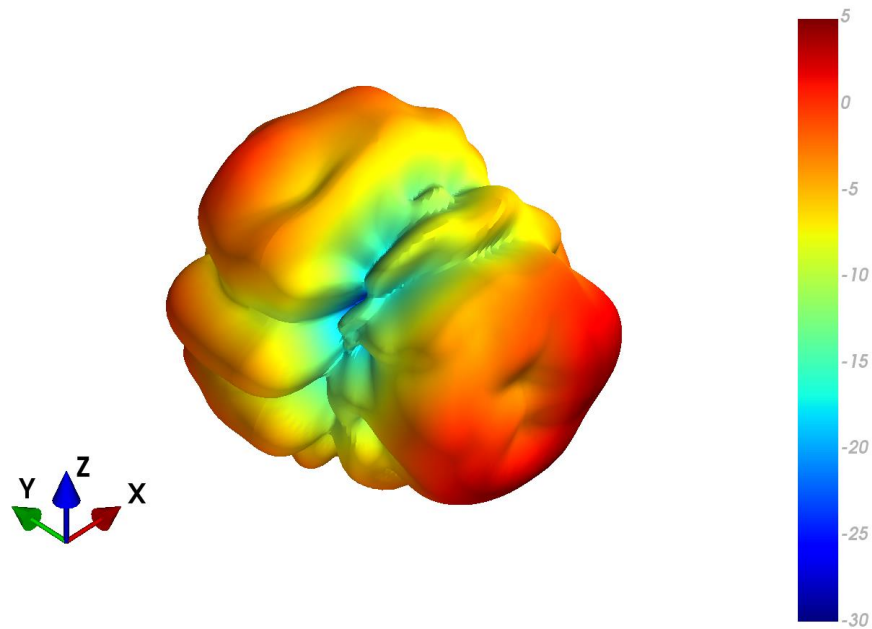

4.5 TFX257.A Patterns at 5150 MHz

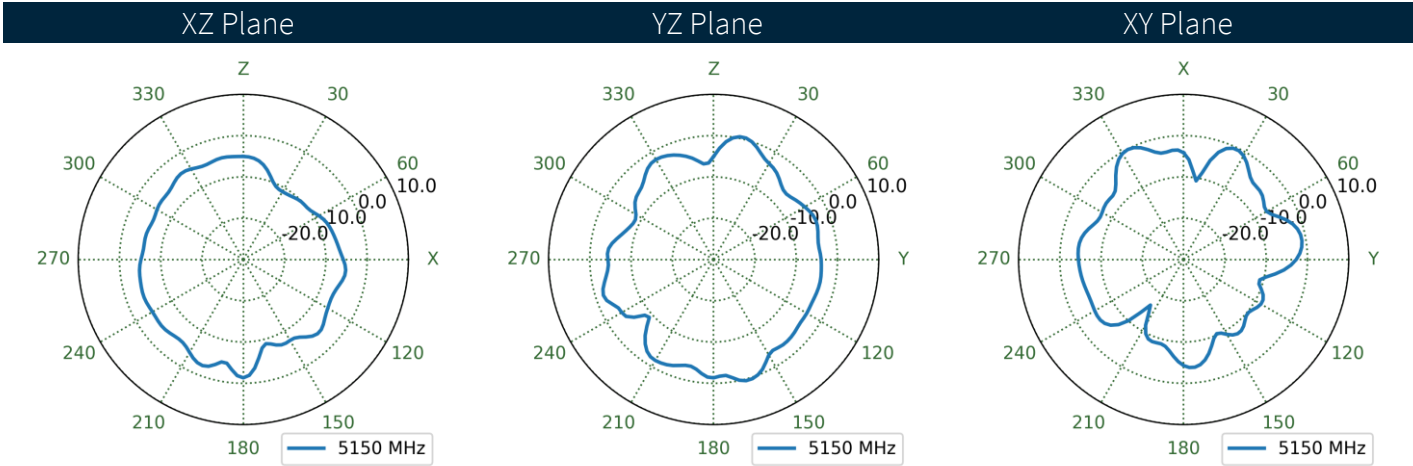
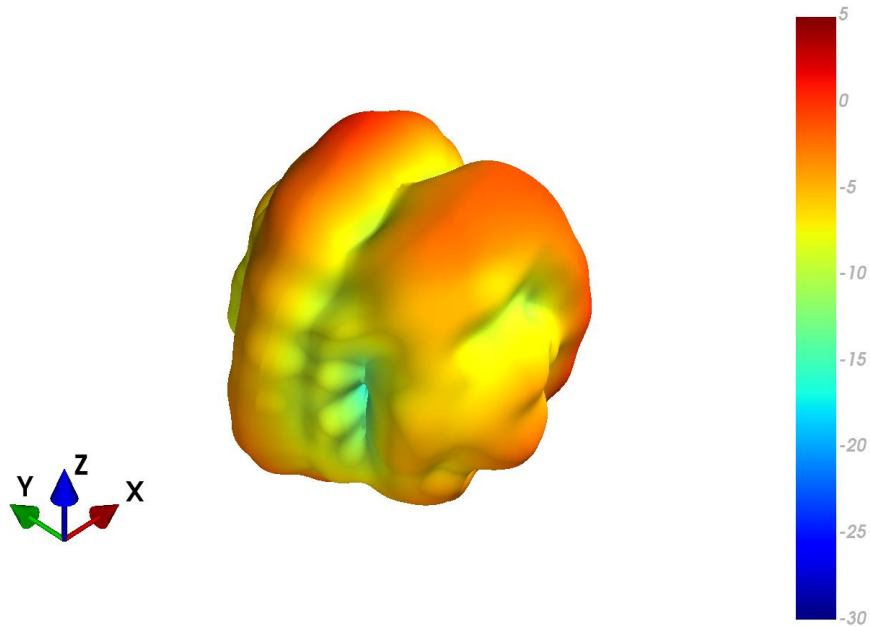

4.6 TFX257.A Patterns at 5500 MHz

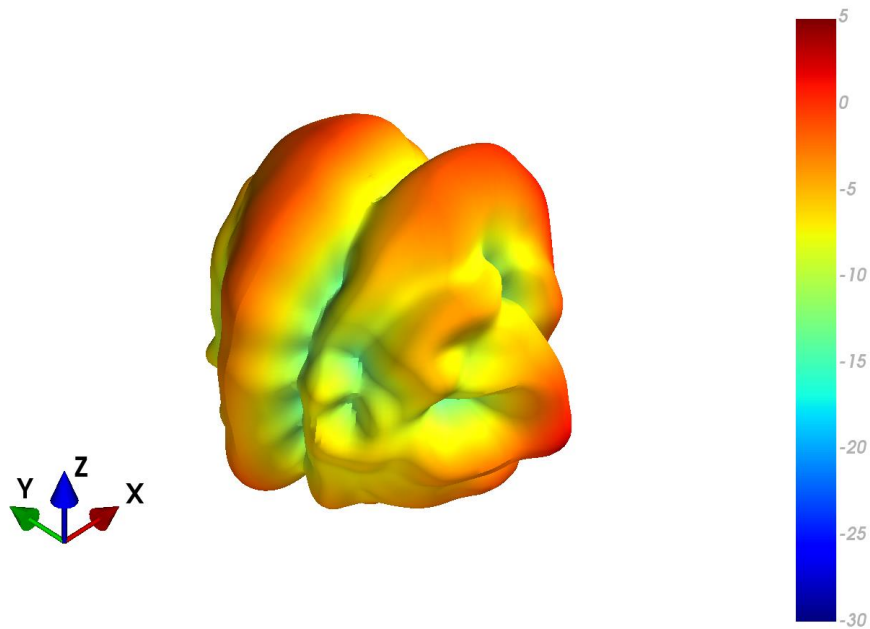

XZ Plane                      YZ Plane                      XY Plane

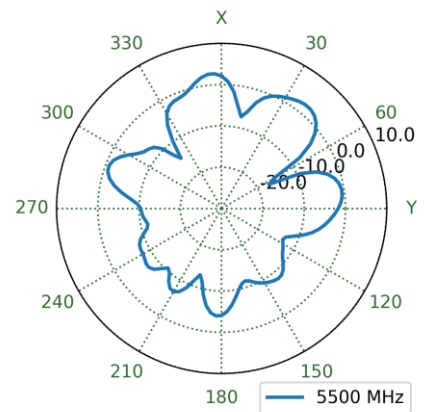
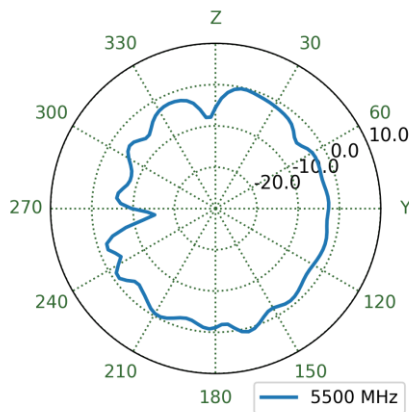
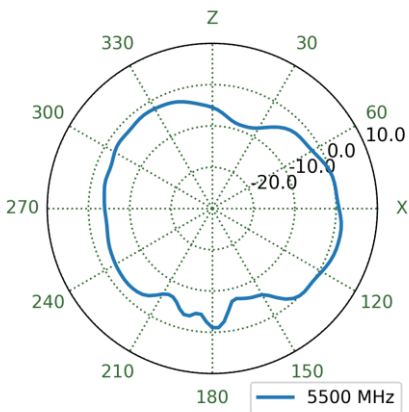

4.7 TFX257.A Patterns at 5850 MHz

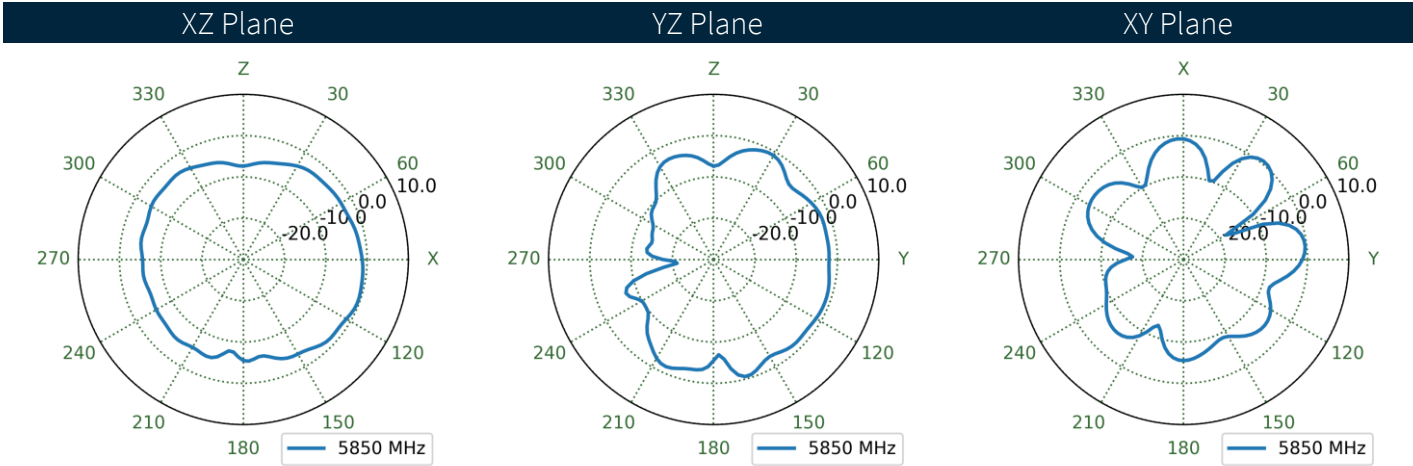
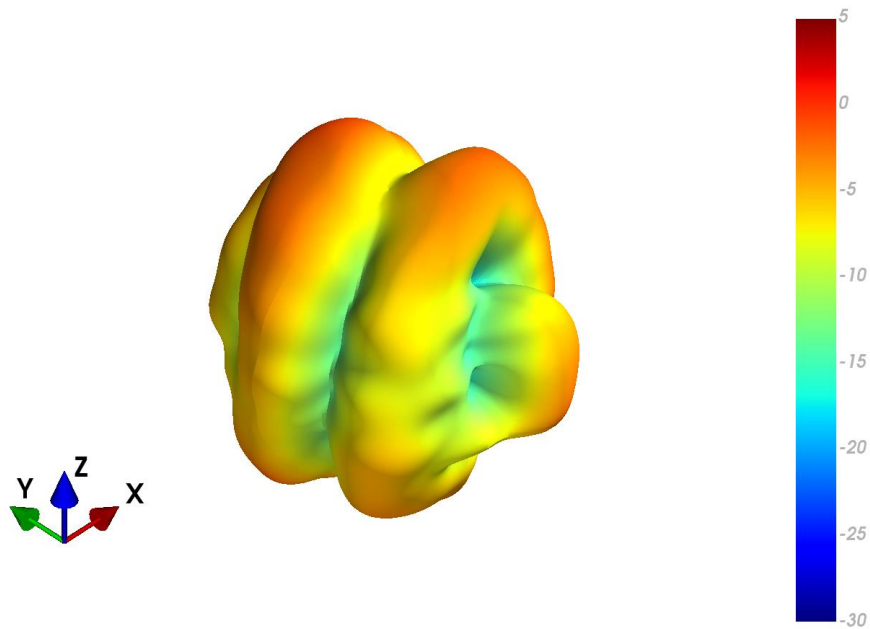

4.8 TFX257.A Patterns at 5925 MHz

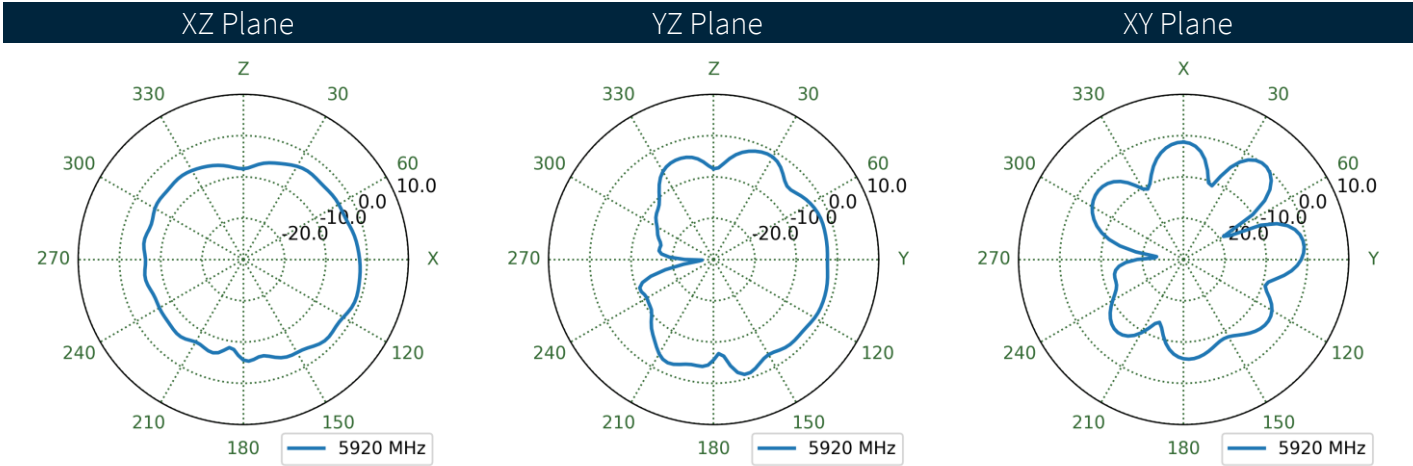
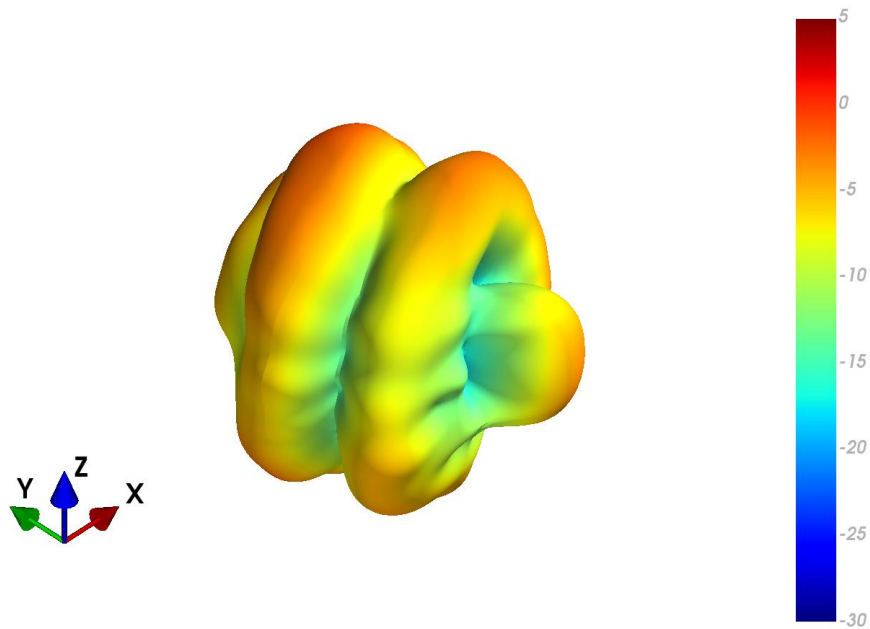

4.9 TFX257.A Patterns at 6525 MHz

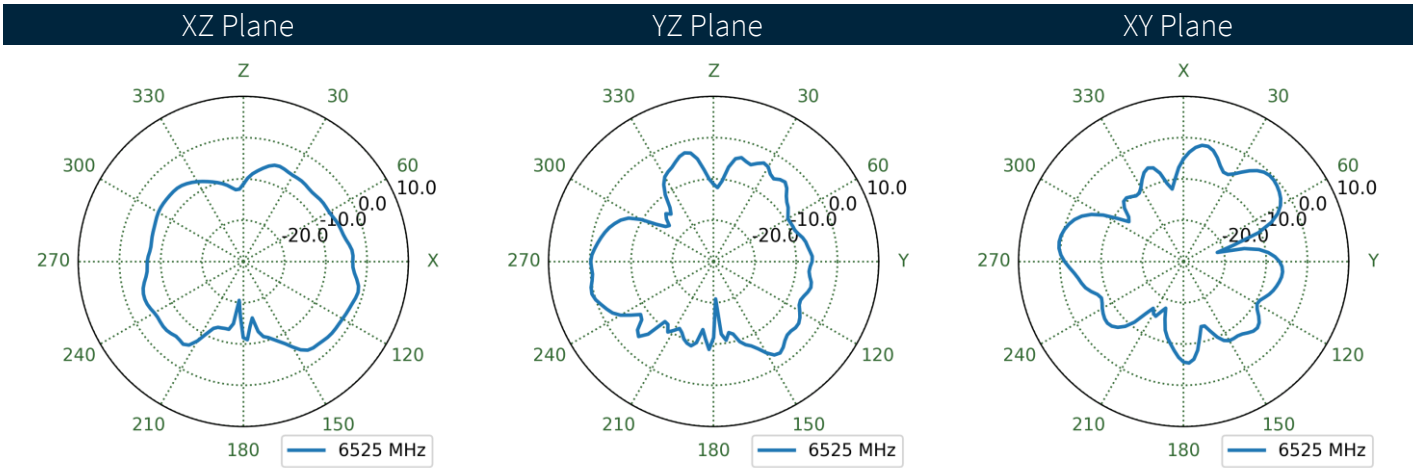
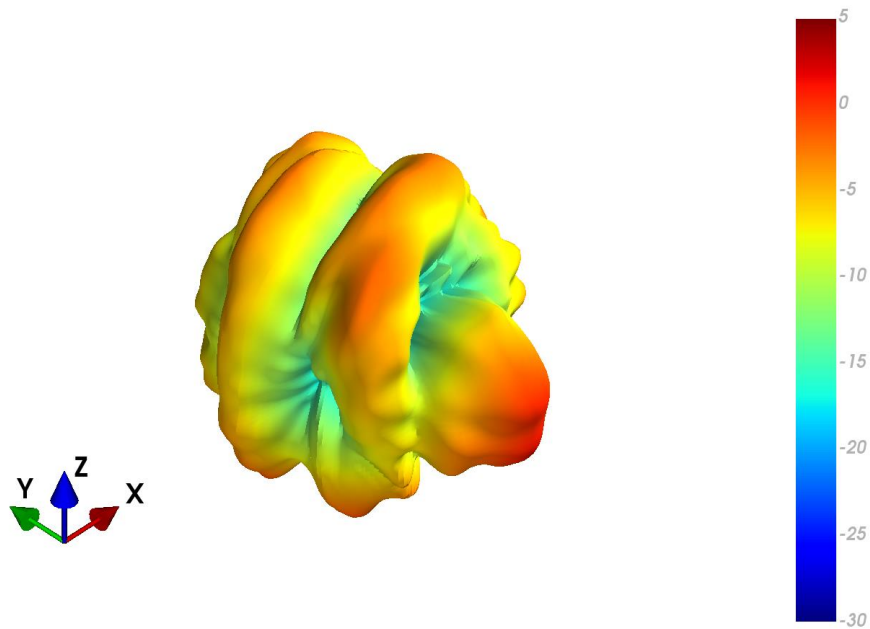

4.10 TFX257.A Patterns at 7125 MHz

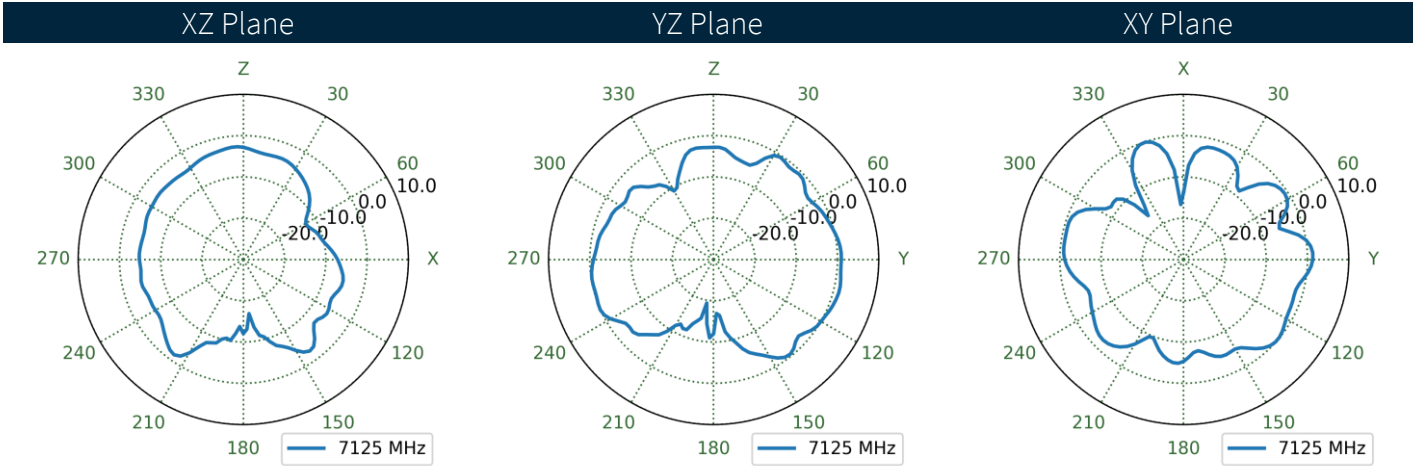
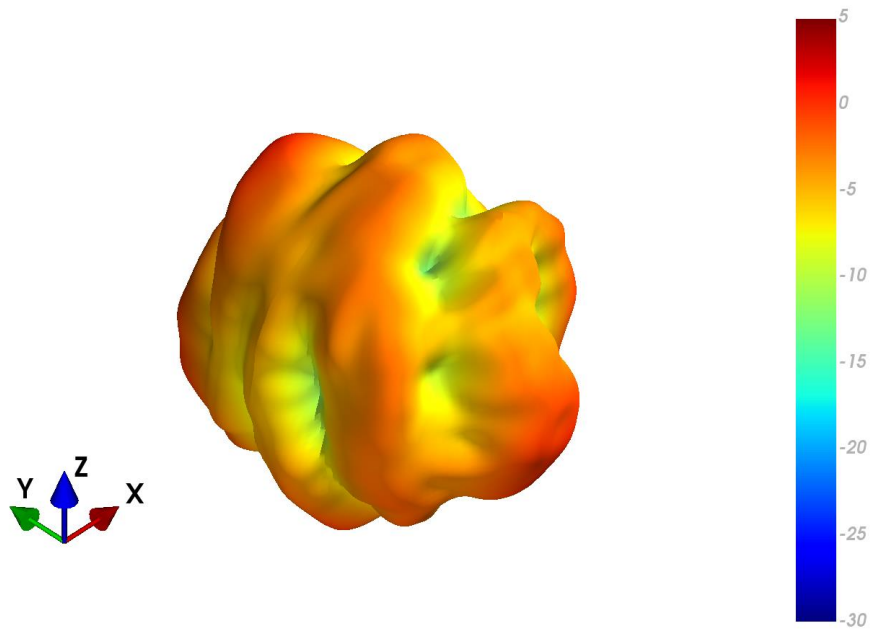

# 5. Mechanical Drawing

ISO NO.: EDW-22-8-0989  
 STATE: RELEASE  
 NOTES: L ALL MATERIAL MUST BE ROHS COMPLIANT.

REVISIONS				
REV.	DESCRIPTION	DATE	ENGINEER	APPROVED
D01	FIRST ISSUE	18OCT2022	SC	WL

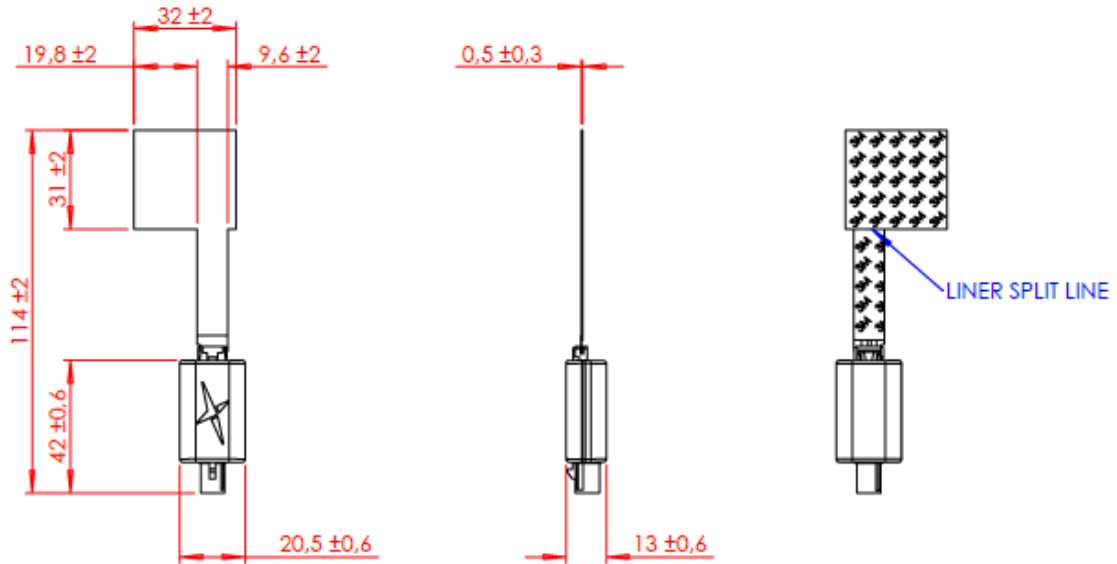

ITEM NO.	DESCRIPTION	MATERIAL	FINISH	QTY
1	TRANSPARENT FLEX WI-FI ANTENNA COVERING 2.4 - 5 - 7.125 GHz	PET	CLEAR	1
2	FPC-to-BOARD CONNECTOR ADAPTOR 2 CONTACT	LCP	BLACK	1
3	ANTENNA PCB HOUSING	ABS/PC	BLACK	1
4	FAKRA CODE I MALE	NYLON/ZINC	BEIGE	1
5	3M ADHESIVE + LINER	3M 8146	BROWN LINER	1

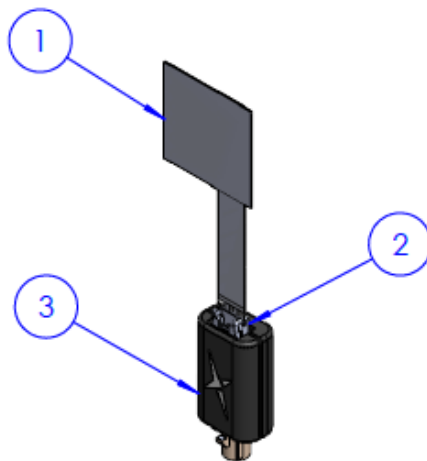

MODEL VIEW  
SCALE 1:2

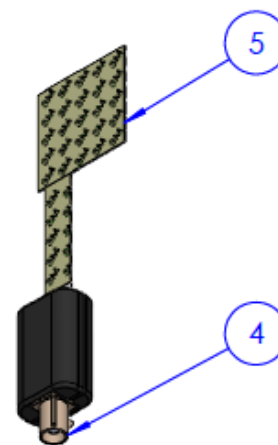

MODEL VIEW  
SCALE 1:2

APPROVED BY: NW	 <small>EMSA Design Centre</small> This drawing and its inherent design concepts are property of Taoglas. Not to be copied or given to third parties without the written consent of Taoglas.
CHECK BY: WL	
DRAWN BY: SC	
DATE: 18OCT2022	
<small>UNLESS OTHERWISE SPECIFIED TOLERANCES ON:</small> X0.005 X0.01 X0.02 X0.05 X0.15	TITLE: <b>TRANSPARENT FLEX WI-FI ANTENNA COVERING 2.4-5-7.125 GHz w/CONVERTER AND FAKRA CODE I MALE</b>
THIRD ANGLE PROJECTION	PART NO.: <b>TFX257.A</b> UNT: mm SCALE: 1:2 PAGES: 1/1 REV: D01

## 6. Packaging

TBD

Changelog for the datasheet

**SPE-22-8-163 – TFX257.A**

**Revision: B (Current Version)**

Date: 2023-05-18

Notes: Updated Specifications

Author: Cesar Sousa

**Previous Revisions**

**Revision: A (Original First Release)**

Date: 2022-10-14

Notes: Initial Release

Author: Gary West



[www.taoglas.com](http://www.taoglas.com)



# Mouser Electronics

Authorized Distributor

Click to View Pricing, Inventory, Delivery & Lifecycle Information:

[Taoglas:](#)

[TFX257.A](#)