

Low Voltage 5-Bit Self-Timed, Single-Wire Output Expander

Check for Samples: [TCA5405](#)

FEATURES

- Operating Power-Supply Voltage Range of 1.65 V to 3.6 V
- Five Independent Push-Pull Outputs
- Single Input (DIN) Controls State of All Outputs
- High-Current Drive Outputs Maximum Capability for Directly Driving LEDs
- Latch-Up Performance Exceeds 100 mA Per JESD 78, Class II
- ESD Protection Exceeds JESD 22
 - 2000-V Human-Body Model (A114-A)
 - 1000-V Charged-Device Model (C101)

RUG PACKAGE (TOP VIEW)

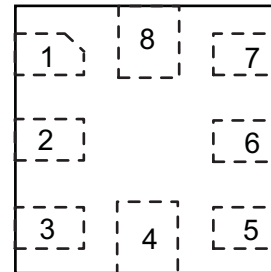

PIN #	NAME	COMMENTS
1	VCC	Supply Voltage
2	DIN	Data Input
3	GND	Ground
4	Q0	GPO
5	Q1	GPO
6	Q2	GPO
7	Q3	GPO
8	Q4	GPO

APPLICATIONS

- Cell Phones
- PDAs
- Portable Media Players
- MP3 Players
- Portable Instrumentation

DESCRIPTION

The TCA5405 is a 5-bit output expander controlled using a single wire input. This device is ideal for portable applications as it has a wide VCC range of 1.65V to 3.6 V. The TCA5405 uses a self-timed serial data protocol with a single data input driven by a master device synchronized to an internal clock of that device. During a Setup phase, the bit period is sampled, then the TCA5405 generates its own internal clock synchronized to that of the Master device to sample the input over a five-bit-period Data Transfer phase and writes the bit states on the parallel outputs after the last bit is sampled. The TCA5405 is available in an 8-pin 1.5mm x 1.5mm RUG uQFN package.

ORDERING INFORMATION

T _A	PACKAGE ⁽¹⁾		ORDERABLE PART NUMBER	TOP-SIDE MARKING
–40°C to 85°C	uQFN – RUG	Tape and Reel	TCA5405RUGR	6Y

(1) Package drawings, standard packing quantities, thermal data, symbolization, and PCB design guidelines are available at www.ti.com/sc/package.



Please be aware that an important notice concerning availability, standard warranty, and use in critical applications of Texas Instruments semiconductor products and disclaimers thereto appears at the end of this data sheet.



These devices have limited built-in ESD protection. The leads should be shorted together or the device placed in conductive foam during storage or handling to prevent electrostatic damage to the MOS gates.

APPLICATION DIAGRAM

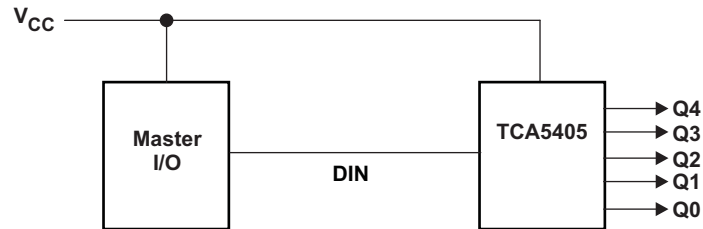

Figure 1. TCA5405 Application Diagram

ABSOLUTE MAXIMUM RATINGS⁽¹⁾

over operating free-air temperature range (unless otherwise noted)

			MIN	MAX	UNIT
V_{CC}	Supply voltage range		-0.5	4.0	V
V_I	Input voltage range ⁽²⁾		-0.5	4.0	V
V_O	Output voltage range ⁽²⁾		-0.5	4.0	V
I_{IK}	Input clamp current	$V_I < 0$		±20	mA
I_{OK}	Output clamp current	$V_O < 0$		±20	mA
I_{OL}	Continuous output low current	$V_O = 0$ to V_{CC}		50	mA
I_{OH}	Continuous output high current	$V_O = 0$ to V_{CC}		50	mA
I_{CC}	Continuous current through GND			200	mA
	Continuous current through V_{CC}			160	
θ_{JA}	Package thermal impedance ⁽³⁾	RUG package		243	°C/W
TSTG	Storage temperature range		-65	150	°C

- (1) Stresses above these ratings may cause permanent damage. Exposure to absolute maximum conditions for extended periods may degrade device reliability. These are stress ratings only, and functional operation of the device at these or any other conditions beyond those specified is not implied.
- (2) The input negative-voltage and output voltage ratings may be exceeded if the input and output current ratings are observed.
- (3) The package thermal impedance is calculated in accordance with JESD 51-7.

RECOMMENDED OPERATING CONDITIONS

			MIN	MAX	UNIT
V_{CC}	Supply voltage		1.65	3.6	V
V_{IH}	High-level input voltage	DIN	$0.7 \times V_{CC}$	$V_{CC} + 0.5$	V
V_{IL}	Low-level input voltage	DIN	-0.3	$0.3 \times V_{CC}$	V
I_{OH}	High-level output current	Q0–Q4		20	mA
I_{OL}	Low-level output current	Q0–Q4		20	mA
T_A	Operating free-air temperature		-40	85	°C

ELECTRICAL CHARACTERISTICS

 over recommended operating free-air temperature range, $V_{CC} = 1.65\text{ V to }3.6\text{ V}$ (unless otherwise noted)

PARAMETER		TEST CONDITIONS	V_{CC}	MIN	TYP	MAX	UNIT
V_{IK}	Input diode clamp voltage	$I_I = -18\text{ mA}$	1.65 V to 3.6 V	-1.2			V
V_{POR}	Power on reset voltage	$V_I = V_{CC}$ or GND, $I_O = 0$	1.65 V to 3.6 V		1	1.4	V
I_I	DIN	$V_I = V_{CC}$ or GND	1.65 V to 3.6 V			± 0.1	μA
I_{CC_STBY}	Standby Supply Current	V_I on DIN = V_{CC} or GND, $I_O = 0$	1.65 V to 3.6 V		1	2	μA
I_{CC_ACTIVE}	Active current during startup and data transfer					400	μA
C_I	DIN	$V_I = V_{CC}$ or GND	1.65 V to 3.6 V		6	7	pF
V_{OH}	OUT-port high-level output voltage	$I_{OH} = -20\text{ mA}$	1.65 V	1.1			V
			2.3 V	1.7			
			3.6 V	2.5			
V_{OL}	OUT-port low-level output voltage	$I_{OL} = 20\text{ mA}$	1.65 V			0.6	V
			2.3 V			0.3	
			3.6 V			0.25	

TIMING REQUIREMENTS

 over recommended operating free-air temperature range, $V_{CC} = 1.65\text{ V to }3.6\text{ V}$ (unless otherwise noted)

PARAMETER		TEST CONDITIONS	VCC	MIN	TYP	MAX	UNIT
t_{PER}	DIN period		1.65 V to 3.6 V	0.001		10	ms
t_{rise}	DIN rise time		1.65 V to 3.6 V			100	ns
t_{fall}	DIN fall time		1.65 V to 3.6 V			100	ns
f_{MIN}	Maximum switching frequency on DIN		1.65 V to 3.6 V	1			MHz
f_{MAX}	Minimum switching frequency on DIN		1.65 V to 3.6 V			10	kHz

PRINCIPLES OF OPERATION

The TCA5405 single-wire bus device has a single-bit Data Line Bus input and has five independent parallel push-pull buffered outputs. A single input is used to control the output state for the writing to these five outputs. This single-wire serial interface is similar to a UART type interface but operates over a wide range of values for the bit period.

The TCA5405 uses a self-timed serial data protocol with a single data input driven by a master device synchronized to an internal clock of that device. During a Setup phase, the bit period is sampled, then the TCA5405 generates its own internal clock synchronized to that of the Master device to sample the input over a five-bit-period Data Transfer phase and writes the bit states on the parallel outputs after the last bit is sampled. The Master output bit must be transmitted via a Totem-pole output structure to ensure proper interpretation of the incoming serial burst.

The single-wire unidirectional interface operation is defined in [Figure 2](#).

INTERFACE TIMING

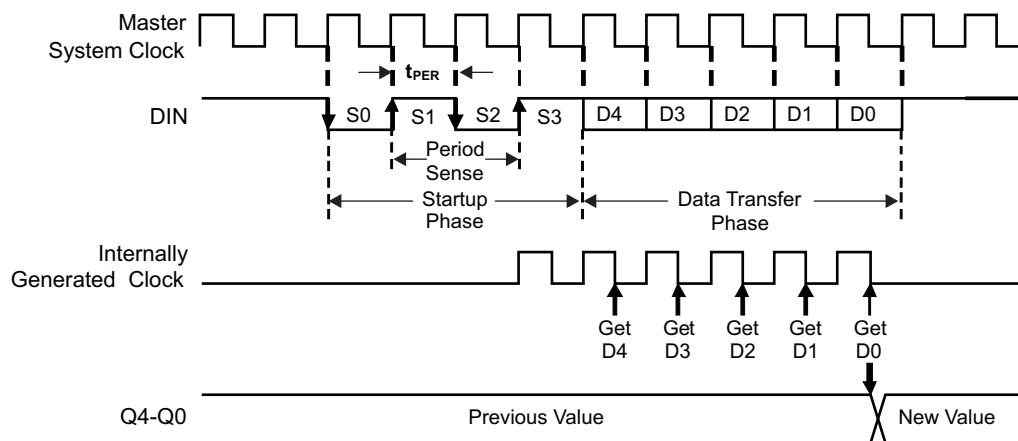

Figure 2. Definition of Single-Wire Interface

To function correctly, the bit period (t_{PER}) of the DIN signal must be constant over the entire data transaction. Therefore, DIN should be driven by a stable periodic signal internal to the Master device (see Figure 2 - Master System Clock). The bit period can be any value between $1\mu\text{S}$ and 10mS .

The TCA5405 first detects the falling transition on DIN at the beginning of the S_0 period to signal the start of an incoming data burst. Next, over the period of S_1 and S_2 , between the two rising edges on DIN, a timer measures the duration of S_1/S_2 to calculate the bit period of the incoming signal. After that, the TCA5405 uses that value to generate its own internal clock which it uses to sample DIN as near as possible to the center of the subsequent D_4 - D_0 bit periods. After bit D_0 is sampled, the five sampled values are sent to the Q_4 - Q_0 outputs. At the end of the D_0 bit period, if DIN is not already high, it must be set high to signal the end of the transaction and to prepare for the next one.

TYPICAL CHARACTERISTICS

$T_A = 25^\circ\text{C}$ (unless otherwise noted)

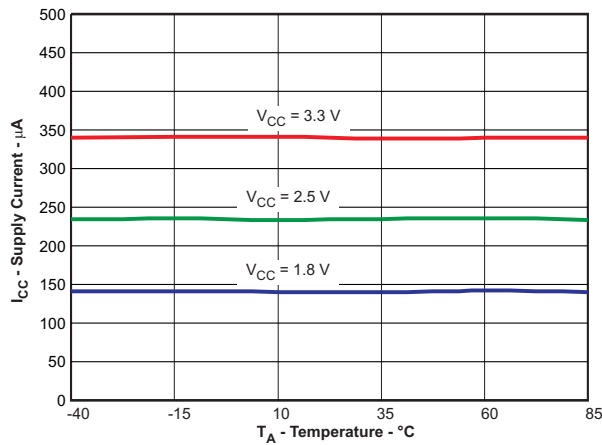

Figure 3. Active Current vs Temperature

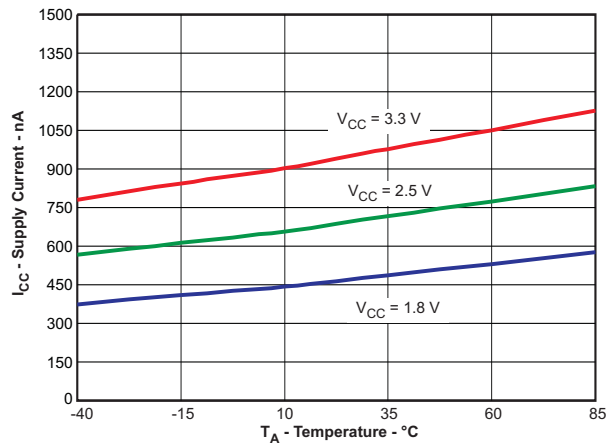

Figure 4. Standby Supply Current vs Temperature

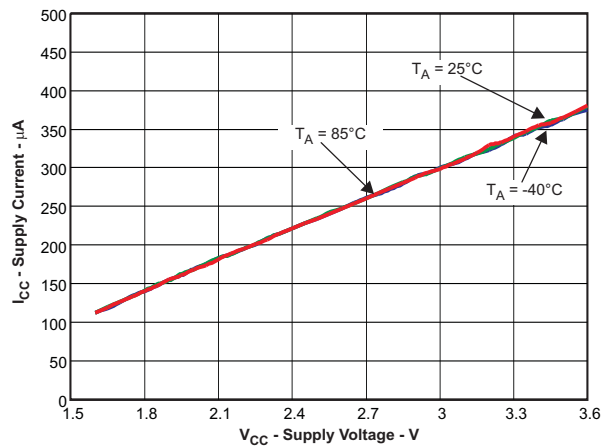

Figure 5. Active Supply Current vs Supply Voltage

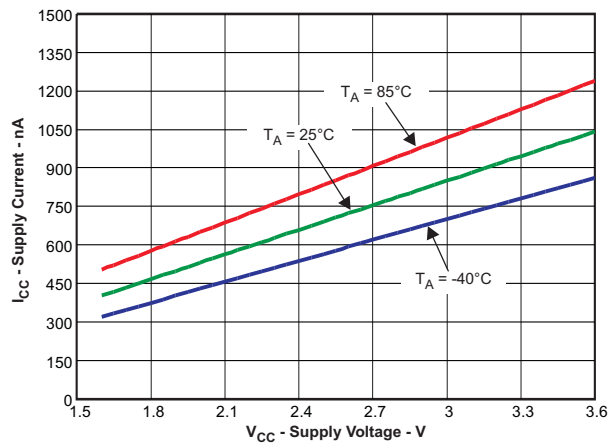

Figure 6. Standby Supply Current vs Supply Voltage

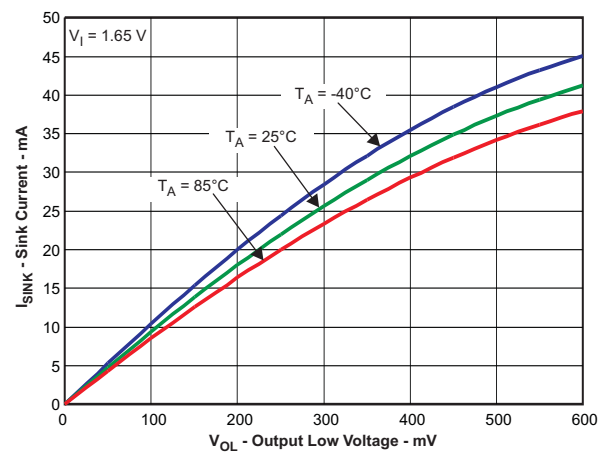

Figure 7. I/O Sink Current vs Output Low Voltage $V_{CC} = 1.65\text{V}$

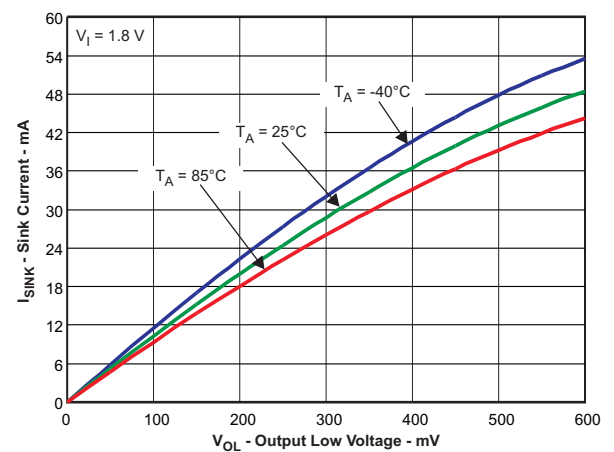

Figure 8. I/O Sink Current vs Output Low Voltage $V_{CC} = 1.8\text{V}$

TYPICAL CHARACTERISTICS (continued)

$T_A = 25^\circ\text{C}$ (unless otherwise noted)

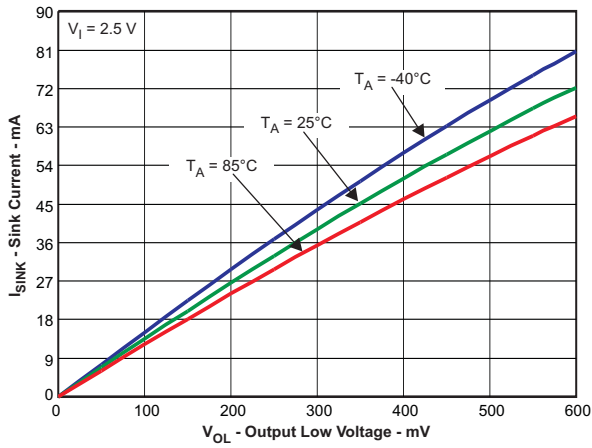

Figure 9. I/O Sink Current vs Output Low Voltage VCC = 2.5V

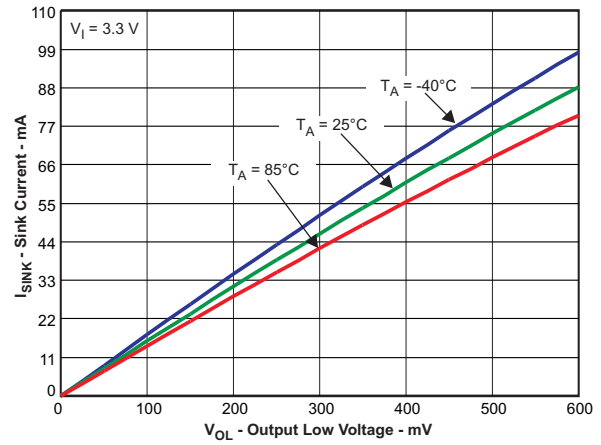

Figure 10. I/O Sink Current vs Output Low Voltage VCC = 3.3V

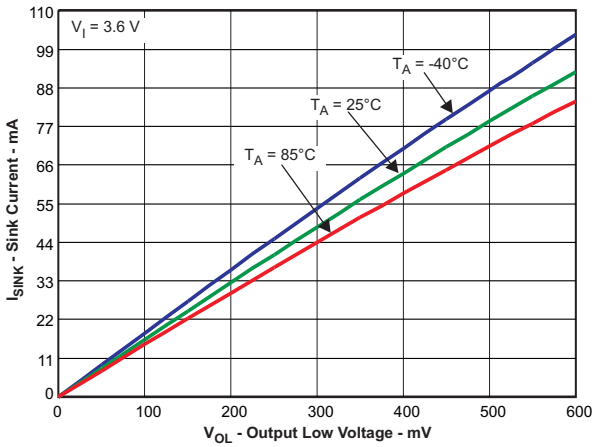

Figure 11. I/O Sink Current vs Output Low Voltage VCC = 3.6V

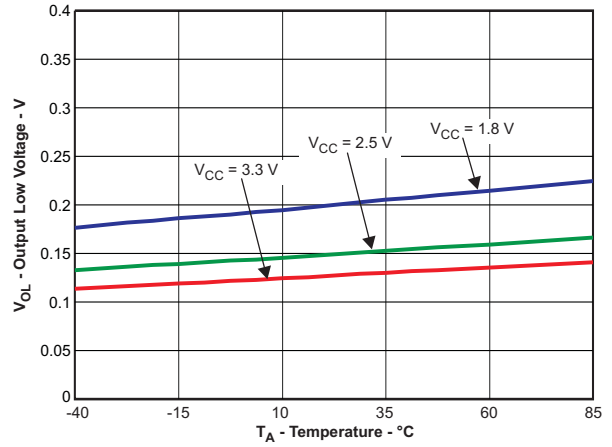

Figure 12. I/O Low Voltage vs Temperature VCC = 3.3V at 20 mA

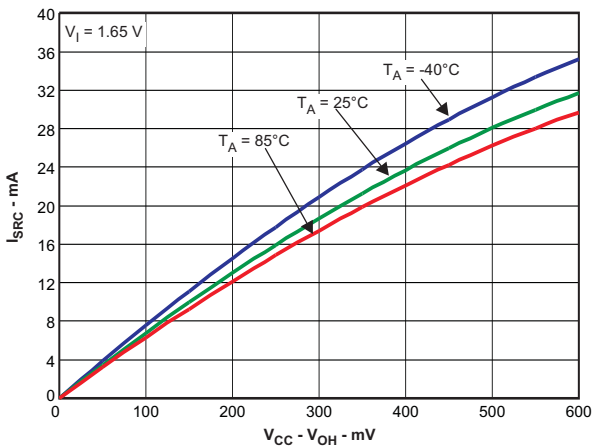

Figure 13. I/O Source Current vs Output High Voltage VCC = 1.65V

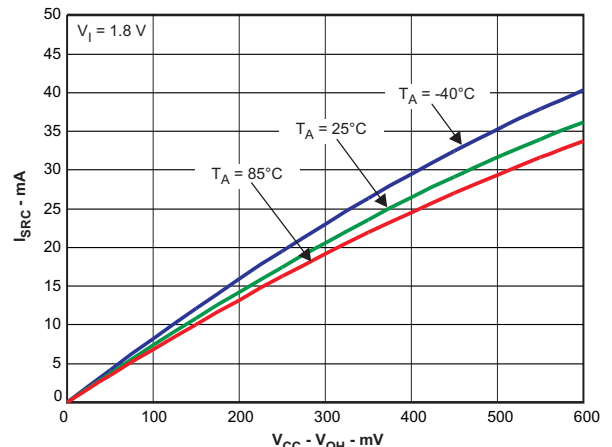

Figure 14. I/O Source Current vs Output High Voltage VCC = 1.8V

TYPICAL CHARACTERISTICS (continued)

T_A = 25°C (unless otherwise noted)

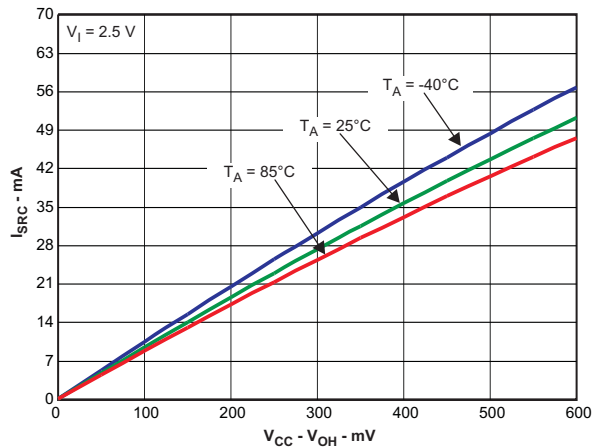

Figure 15. I/O Source Current vs Output High Voltage VCC = 2.5V

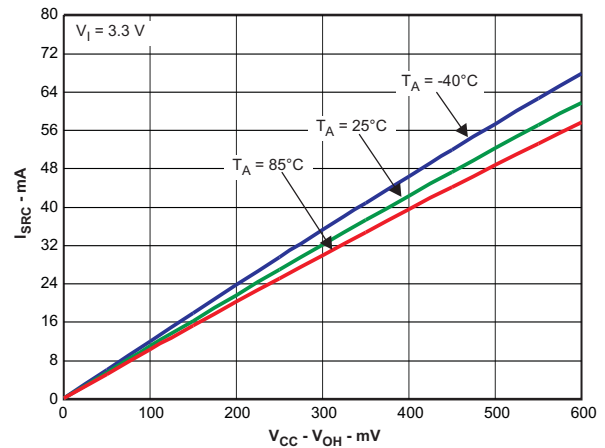

Figure 16. I/O Source Current vs Output High Voltage VCC = 3.3V

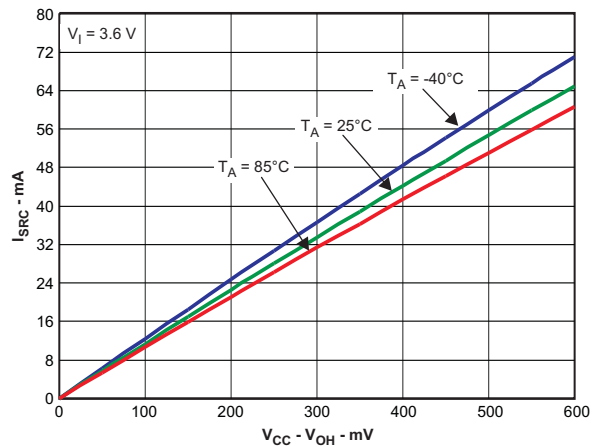

Figure 17. I/O Source Current vs Output High Voltage VCC = 3.6V

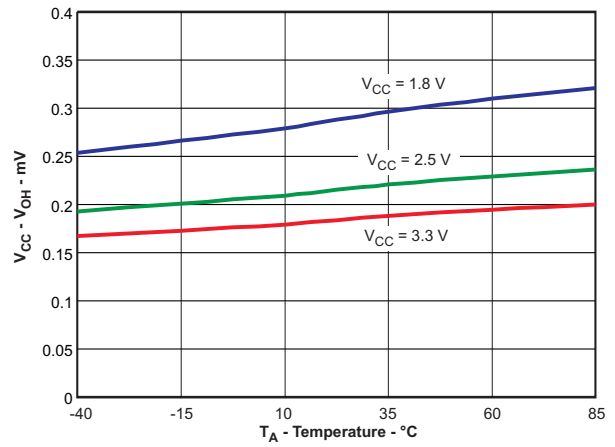

Figure 18. I/O High Voltage vs Temperature VCC = 3.3V at 20 mA

PACKAGING INFORMATION

Orderable Device	Status (1)	Package Type	Package Drawing	Pins	Package Qty	Eco Plan (2)	Lead/Ball Finish	MSL Peak Temp (3)	Op Temp (°C)	Device Marking (4/5)	Samples
TCA5405RUGR	ACTIVE	X2QFN	RUG	8	3000	Green (RoHS & no Sb/Br)	CU NIPDAU	Level-1-260C-UNLIM	-40 to 85	6Y	Samples

(1) The marketing status values are defined as follows:

ACTIVE: Product device recommended for new designs.

LIFEBUY: TI has announced that the device will be discontinued, and a lifetime-buy period is in effect.

NRND: Not recommended for new designs. Device is in production to support existing customers, but TI does not recommend using this part in a new design.

PREVIEW: Device has been announced but is not in production. Samples may or may not be available.

OBSOLETE: TI has discontinued the production of the device.

(2) Eco Plan - The planned eco-friendly classification: Pb-Free (RoHS), Pb-Free (RoHS Exempt), or Green (RoHS & no Sb/Br) - please check <http://www.ti.com/productcontent> for the latest availability information and additional product content details.

TBD: The Pb-Free/Green conversion plan has not been defined.

Pb-Free (RoHS): TI's terms "Lead-Free" or "Pb-Free" mean semiconductor products that are compatible with the current RoHS requirements for all 6 substances, including the requirement that lead not exceed 0.1% by weight in homogeneous materials. Where designed to be soldered at high temperatures, TI Pb-Free products are suitable for use in specified lead-free processes.

Pb-Free (RoHS Exempt): This component has a RoHS exemption for either 1) lead-based flip-chip solder bumps used between the die and package, or 2) lead-based die adhesive used between the die and leadframe. The component is otherwise considered Pb-Free (RoHS compatible) as defined above.

Green (RoHS & no Sb/Br): TI defines "Green" to mean Pb-Free (RoHS compatible), and free of Bromine (Br) and Antimony (Sb) based flame retardants (Br or Sb do not exceed 0.1% by weight in homogeneous material)

(3) MSL, Peak Temp. -- The Moisture Sensitivity Level rating according to the JEDEC industry standard classifications, and peak solder temperature.

(4) There may be additional marking, which relates to the logo, the lot trace code information, or the environmental category on the device.

(5) Multiple Device Markings will be inside parentheses. Only one Device Marking contained in parentheses and separated by a "-" will appear on a device. If a line is indented then it is a continuation of the previous line and the two combined represent the entire Device Marking for that device.

Important Information and Disclaimer: The information provided on this page represents TI's knowledge and belief as of the date that it is provided. TI bases its knowledge and belief on information provided by third parties, and makes no representation or warranty as to the accuracy of such information. Efforts are underway to better integrate information from third parties. TI has taken and continues to take reasonable steps to provide representative and accurate information but may not have conducted destructive testing or chemical analysis on incoming materials and chemicals. TI and TI suppliers consider certain information to be proprietary, and thus CAS numbers and other limited information may not be available for release.

In no event shall TI's liability arising out of such information exceed the total purchase price of the TI part(s) at issue in this document sold by TI to Customer on an annual basis.

TAPE AND REEL INFORMATION

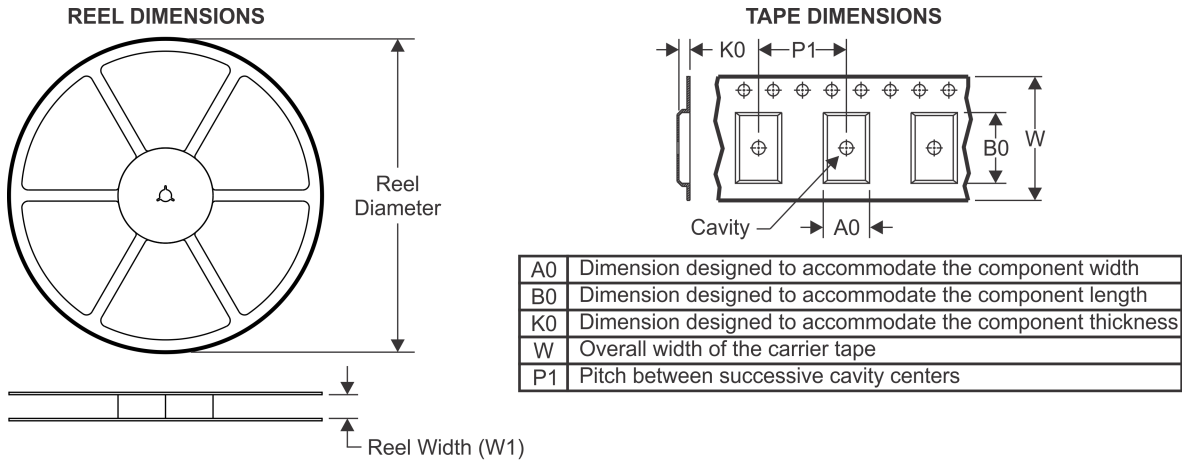

QUADRANT ASSIGNMENTS FOR PIN 1 ORIENTATION IN TAPE

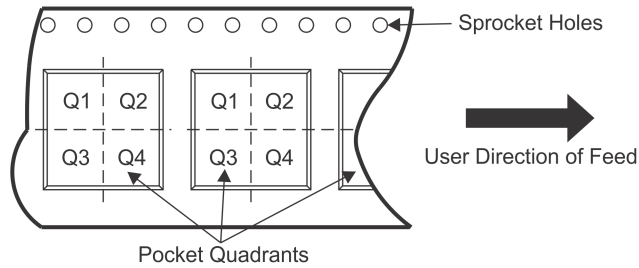

*All dimensions are nominal

Device	Package Type	Package Drawing	Pins	SPQ	Reel Diameter (mm)	Reel Width W1 (mm)	A0 (mm)	B0 (mm)	K0 (mm)	P1 (mm)	W (mm)	Pin1 Quadrant
TCA5405RUGR	X2QFN	RUG	8	3000	180.0	8.4	1.7	1.7	0.7	4.0	8.0	Q2

TAPE AND REEL BOX DIMENSIONS



*All dimensions are nominal

Device	Package Type	Package Drawing	Pins	SPQ	Length (mm)	Width (mm)	Height (mm)
TCA5405RUGR	X2QFN	RUG	8	3000	202.0	201.0	28.0

RUG (R-PQFP-N8)

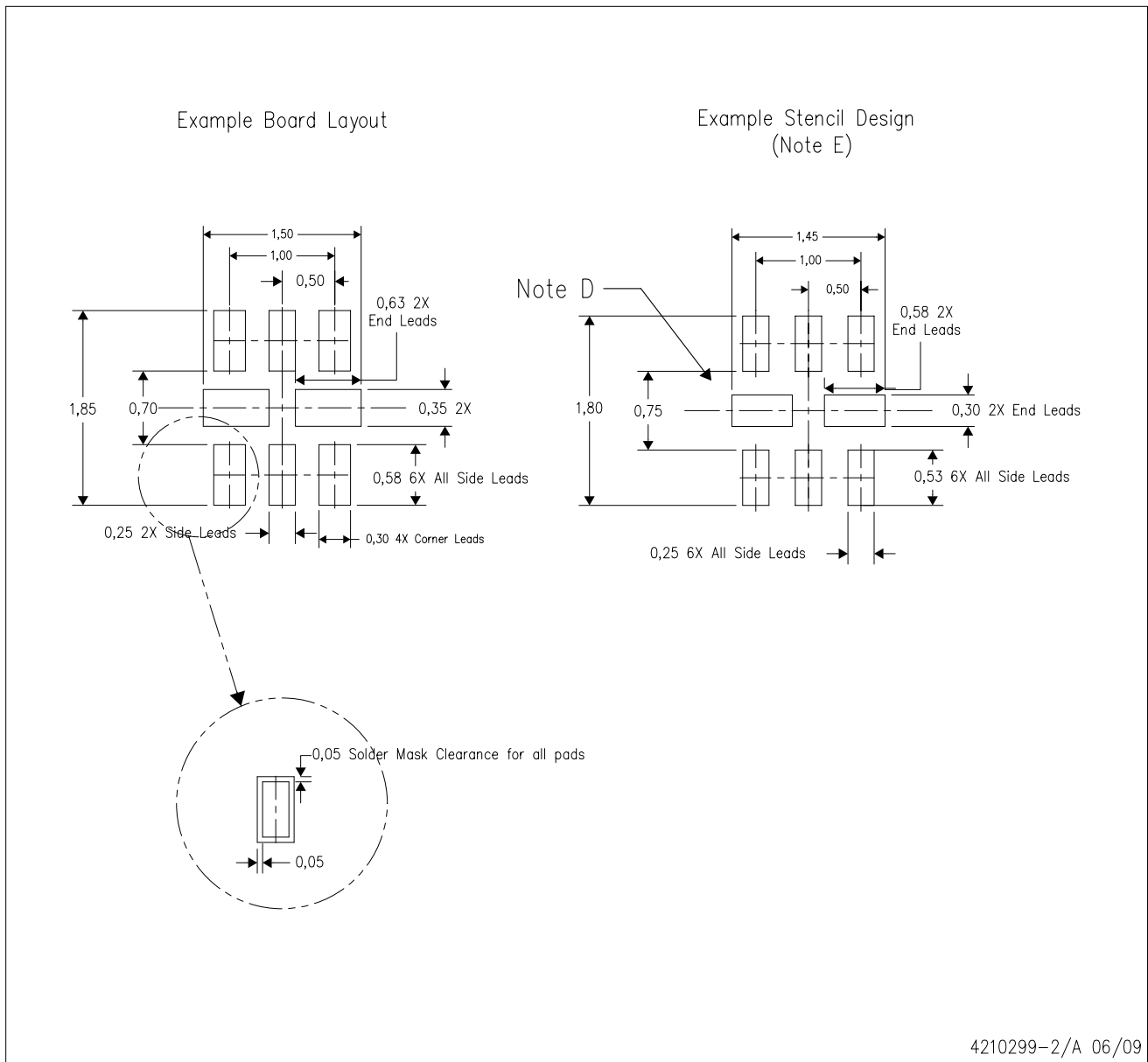

4210299-2/A 06/09

- NOTES:
- A. All linear dimensions are in millimeters.
 - B. This drawing is subject to change without notice.
 - C. Publication IPC-7351 is recommended for alternate designs.
 - D. Customers should contact their board fabrication site for minimum solder mask web tolerances between signal pads.
 - E. Maximum stencil thickness 0,127 mm (5 mils). All linear dimensions are in millimeters.
 - F. Laser cutting apertures with trapezoidal walls and also rounding corners will offer better paste release. Customers should contact their board assembly site for stencil design recommendations. Refer to IPC 7525 for stencil design considerations.
 - G. Side aperture dimensions over-print land for acceptable area ratio > 0.66. Customer may reduce side aperture dimensions if stencil manufacturing process allows for sufficient release at smaller opening.

IMPORTANT NOTICE

Texas Instruments Incorporated and its subsidiaries (TI) reserve the right to make corrections, enhancements, improvements and other changes to its semiconductor products and services per JESD46, latest issue, and to discontinue any product or service per JESD48, latest issue. Buyers should obtain the latest relevant information before placing orders and should verify that such information is current and complete. All semiconductor products (also referred to herein as "components") are sold subject to TI's terms and conditions of sale supplied at the time of order acknowledgment.

TI warrants performance of its components to the specifications applicable at the time of sale, in accordance with the warranty in TI's terms and conditions of sale of semiconductor products. Testing and other quality control techniques are used to the extent TI deems necessary to support this warranty. Except where mandated by applicable law, testing of all parameters of each component is not necessarily performed.

TI assumes no liability for applications assistance or the design of Buyers' products. Buyers are responsible for their products and applications using TI components. To minimize the risks associated with Buyers' products and applications, Buyers should provide adequate design and operating safeguards.

TI does not warrant or represent that any license, either express or implied, is granted under any patent right, copyright, mask work right, or other intellectual property right relating to any combination, machine, or process in which TI components or services are used. Information published by TI regarding third-party products or services does not constitute a license to use such products or services or a warranty or endorsement thereof. Use of such information may require a license from a third party under the patents or other intellectual property of the third party, or a license from TI under the patents or other intellectual property of TI.

Reproduction of significant portions of TI information in TI data books or data sheets is permissible only if reproduction is without alteration and is accompanied by all associated warranties, conditions, limitations, and notices. TI is not responsible or liable for such altered documentation. Information of third parties may be subject to additional restrictions.

Resale of TI components or services with statements different from or beyond the parameters stated by TI for that component or service voids all express and any implied warranties for the associated TI component or service and is an unfair and deceptive business practice. TI is not responsible or liable for any such statements.

Buyer acknowledges and agrees that it is solely responsible for compliance with all legal, regulatory and safety-related requirements concerning its products, and any use of TI components in its applications, notwithstanding any applications-related information or support that may be provided by TI. Buyer represents and agrees that it has all the necessary expertise to create and implement safeguards which anticipate dangerous consequences of failures, monitor failures and their consequences, lessen the likelihood of failures that might cause harm and take appropriate remedial actions. Buyer will fully indemnify TI and its representatives against any damages arising out of the use of any TI components in safety-critical applications.

In some cases, TI components may be promoted specifically to facilitate safety-related applications. With such components, TI's goal is to help enable customers to design and create their own end-product solutions that meet applicable functional safety standards and requirements. Nonetheless, such components are subject to these terms.

No TI components are authorized for use in FDA Class III (or similar life-critical medical equipment) unless authorized officers of the parties have executed a special agreement specifically governing such use.

Only those TI components which TI has specifically designated as military grade or "enhanced plastic" are designed and intended for use in military/aerospace applications or environments. Buyer acknowledges and agrees that any military or aerospace use of TI components which have **not** been so designated is solely at the Buyer's risk, and that Buyer is solely responsible for compliance with all legal and regulatory requirements in connection with such use.

TI has specifically designated certain components as meeting ISO/TS16949 requirements, mainly for automotive use. In any case of use of non-designated products, TI will not be responsible for any failure to meet ISO/TS16949.

Products

Audio	www.ti.com/audio
Amplifiers	amplifier.ti.com
Data Converters	dataconverter.ti.com
DLP® Products	www.dlp.com
DSP	dsp.ti.com
Clocks and Timers	www.ti.com/clocks
Interface	interface.ti.com
Logic	logic.ti.com
Power Mgmt	power.ti.com
Microcontrollers	microcontroller.ti.com
RFID	www.ti-rfid.com
OMAP Applications Processors	www.ti.com/omap
Wireless Connectivity	www.ti.com/wirelessconnectivity

Applications

Automotive and Transportation	www.ti.com/automotive
Communications and Telecom	www.ti.com/communications
Computers and Peripherals	www.ti.com/computers
Consumer Electronics	www.ti.com/consumer-apps
Energy and Lighting	www.ti.com/energy
Industrial	www.ti.com/industrial
Medical	www.ti.com/medical
Security	www.ti.com/security
Space, Avionics and Defense	www.ti.com/space-avionics-defense
Video and Imaging	www.ti.com/video

TI E2E Community

e2e.ti.com