

# 119x38mm

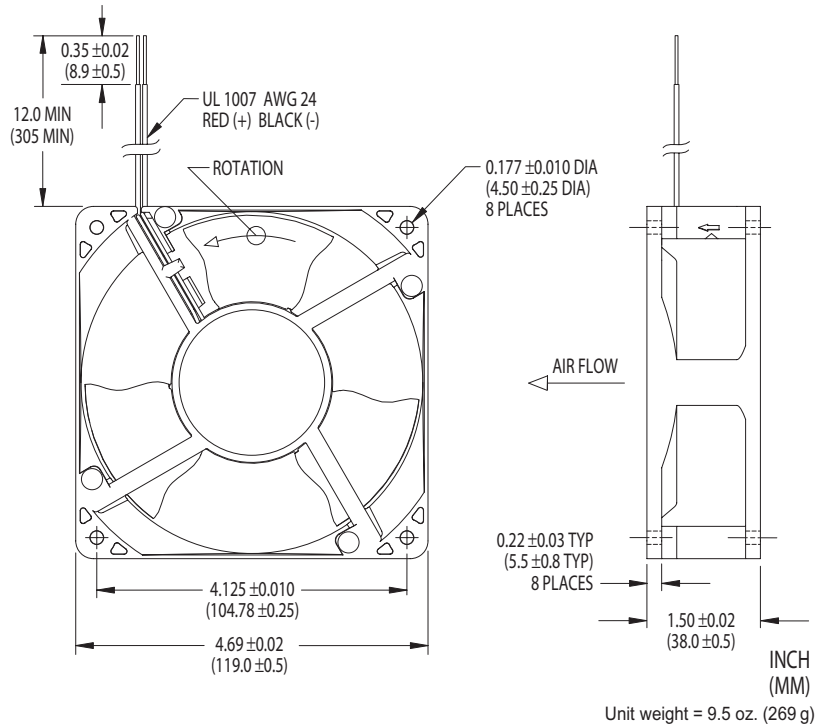

- ▶ 5V, 12V, 24V and 48V Models
- ▶ Polarity Protected
- ▶ Permanently Lubricated Ball Bearings
- ▶ Alarm/Tachometer/Thermal Speed Control/PWM Speed Control Options
- ▶ Sound-Absorbing Thermoplastic Frame and Impeller Rated V-0
- ▶ Color-Coded 11.8 in. (300 mm) Leads



## TA450DC Series—Electrical and Mechanical Characteristics

| Model               | Air Flow (CFM) | Operating Voltage |           | Current (mA) | Power (W) | Sound Level    |             |                 | Bearing | Operating Temp. |           | L10 Life † (hours) |
|---------------------|----------------|-------------------|-----------|--------------|-----------|----------------|-------------|-----------------|---------|-----------------|-----------|--------------------|
|                     |                | Nom. (V)          | Range (V) |              |           | Pressure (dBA) | NPEL (Bels) | Fan Speed (rpm) |         | Min. (°C)       | Max. (°C) |                    |
| B32347              | 60             | 12                | 7.0-14    | 200          | 2.40      | 33.2           | 4.4         | 1,900           | Ball    | -10             | +70       | 76,000             |
| B31787              | 60             | 24                | 12-28     | 100          | 2.40      | 33.2           | 4.4         | 1,900           | Ball    | -10             | +70       | 76,000             |
| B34188              | 70             | 24                | 12-28     | 125          | 3.00      | 36.5           | 4.6         | 2,100           | Ball    | -10             | +70       | 70,600             |
| B34270              | 80             | 5.0               | 4.5-5.5   | 650          | 3.25      | 40.7           | 5.2         | 2,450           | Ball    | -10             | +70       | 65,600             |
| B31873              | 80             | 12                | 7.0-14    | 280          | 3.36      | 41.0           | 5.3         | 2,450           | Ball    | -10             | +70       | 65,600             |
| B32837              | 80             | 24                | 12-28     | 170          | 4.08      | 40.7           | 5.0         | 2,450           | Ball    | -10             | +70       | 65,600             |
| B33050              | 88             | 12                | 7.0-14    | 310          | 3.72      | 43.1           | 5.3         | 2,650           | Ball    | -10             | +70       | 63,800             |
| B33393              | 88             | 24                | 12-28     | 180          | 4.32      | 43.1           | 5.3         | 2,650           | Ball    | -10             | +70       | 63,800             |
| B32286              | 95             | 12                | 7.0-14    | 400          | 4.80      | 47.8           | 5.5         | 2,950           | Ball    | -10             | +70       | 60,300             |
| B31276 <sup>Δ</sup> | 104            | 12                | 7.0-14    | 440          | 5.28      | 51.9           | 6.6         | 3,080           | Ball    | -10             | +70       | 58,900             |
| B31277 <sup>Δ</sup> | 104            | 24                | 12-28     | 310          | 7.44      | 51.9           | 6.6         | 3,080           | Ball    | -10             | +70       | 58,900             |
| B34258              | 108            | 5.0               | 4.5-5.5   | 1250         | 6.25      | 49.1           | 5.7         | 3,200           | Ball    | -10             | +70       | 57,600             |
| B32861              | 108            | 48                | 28-56     | 140          | 6.72      | 48.5           | 5.6         | 3,200           | Ball    | -10             | +70       | 57,600             |
| B31256              | 112            | 12                | 7.0-14    | 490          | 5.88      | 48.4           | 6.0         | 3,250           | Ball    | -10             | +70       | 57,100             |
| B31257              | 112            | 24                | 12-28     | 280          | 6.72      | 48.4           | 6.0         | 3,250           | Ball    | -10             | +70       | 57,100             |
| B34262              | 130            | 12                | 7.0-14    | 800          | 9.60      | 53.5           | 6.6         | 4,050           | Ball    | -10             | +70       | 49,000             |
| B33534              | 130            | 24                | 12-28     | 450          | 10.8      | 53.5           | 6.6         | 4,050           | Ball    | -10             | +70       | 49,000             |
| B34578              | 130            | 48                | 28-56     | 250          | 12.0      | 53.5           | 6.6         | 4,050           | Ball    | -10             | +70       | 49,000             |

Note: Air flow, current, power, speed and sound level ratings are at nominal voltage against zero static pressure. NPEL = Noise Power Emission Level. The first character of the model number designates the housing material and flange configuration (B = thermoplastic housing with open flange). TA450DC fans are also available as 'A' models (die-cast housing, open flange) and 'C' models (thermoplastic housing, closed flange). Die-cast metal versions weigh 21.2 oz. (600 g). Power termination, control and signal options are designated by two-digit suffixes added to the model names: For color-coded 12-inch power leads with stripped ends, add "-16" to the model numbers.

† L10 bearing life expectancy at  $T_A = +40^\circ\text{C}$ , nominal voltage. Failure criteria for life testing that establishes this figure include a 15% reduction in fan speed or a 5 dBA increase in sound pressure.

<sup>Δ</sup> Air flow reversed: Air inlet is on the strut side of the fan.

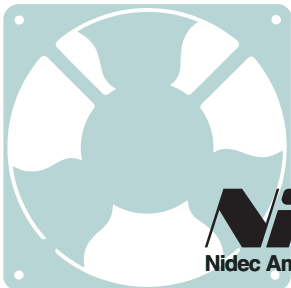

**Nidec**  
Nidec America Corporation

phone 781-848-0970 · email fans@nidecamerica.com · www.nidecamerica.com

# 119x38mm

## TA450DC Air Performance Characteristics

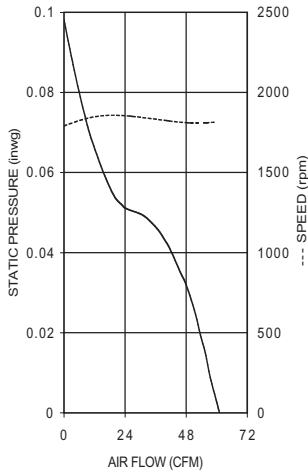

B32347/B31787

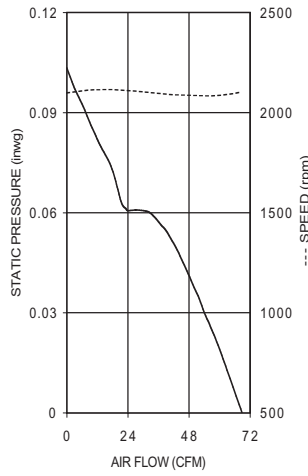

B34188

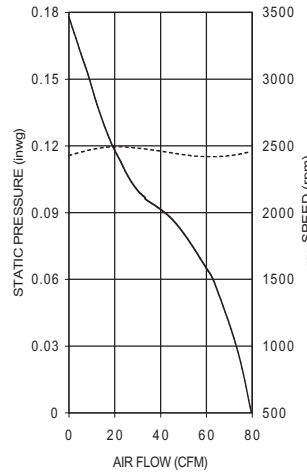

B34270/B32837/B31873

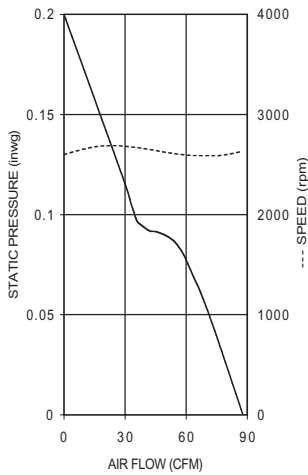

B33050/B33393

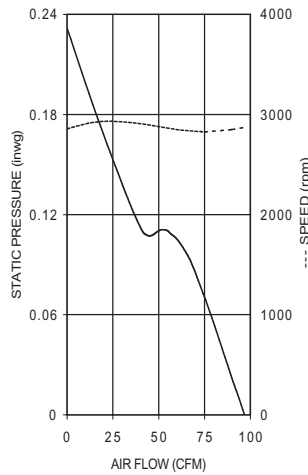

B32286

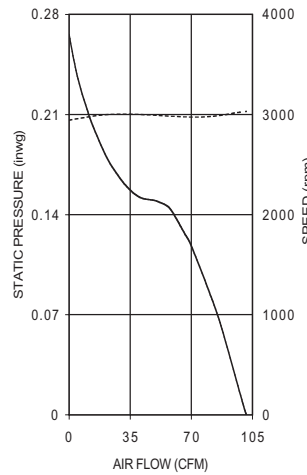

B31276/B31277

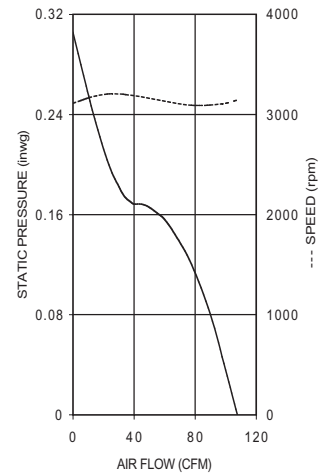

B34258/B32861

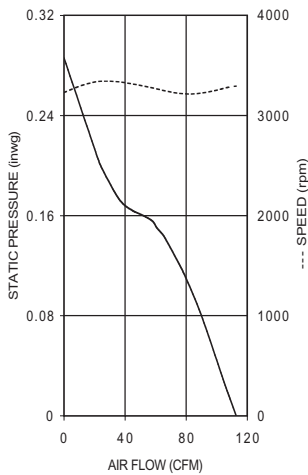

B31256/B31257

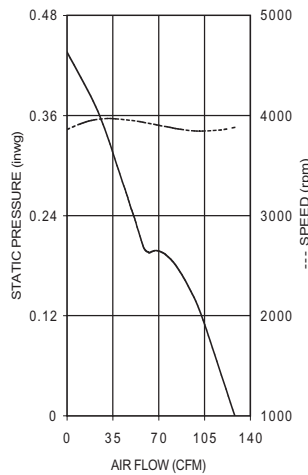

B34262

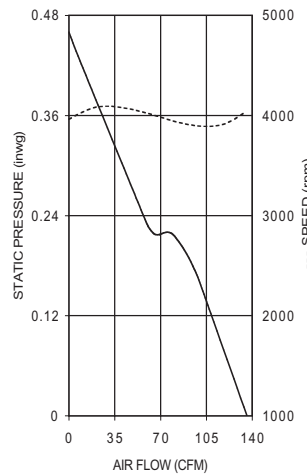

B33534/B34578

