

Powerex, Inc., 200 Hillis Street, Youngwood, Pennsylvania 15697-1800 (412) 925-7272
 Powerex, Europe, S.A. 428 Avenue G. Durand, BP107, 72003 Le Mans, France (43) 41.14.14

Phase Control SCR
 300-400 Amperes
 1200 Volts

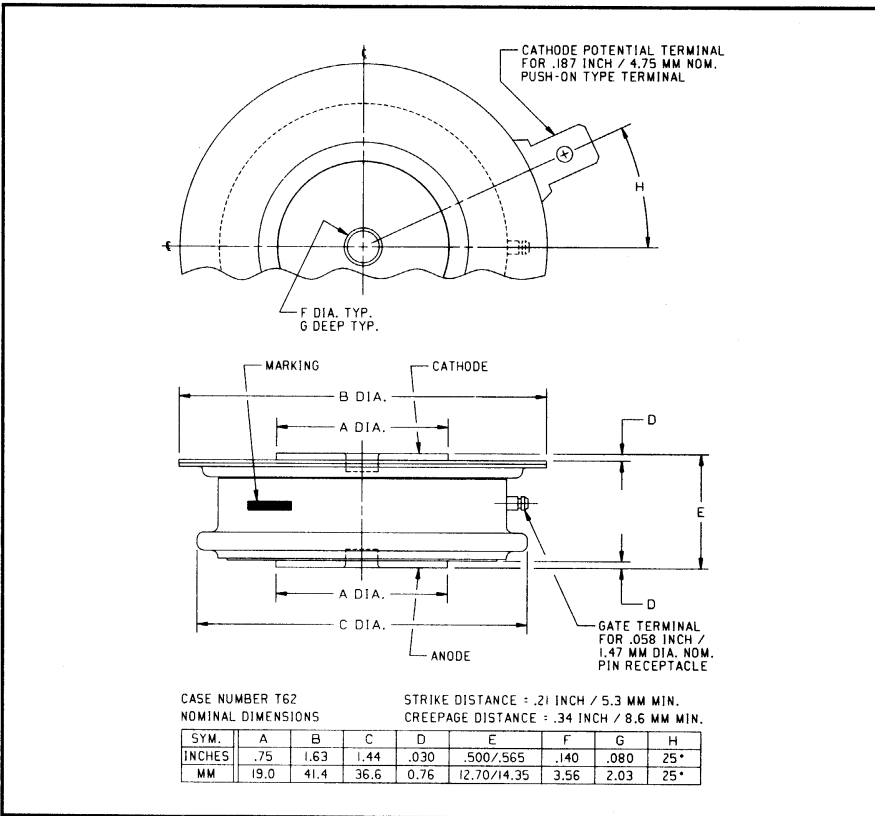

T625 (Outline Drawing)

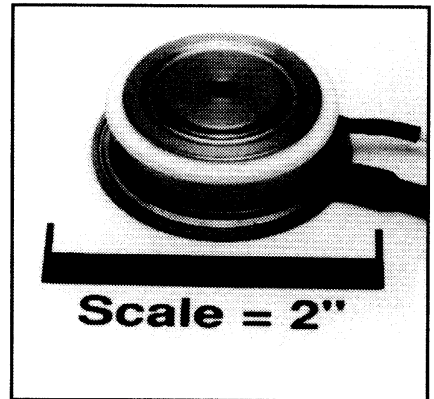

T625 Phase Control SCR
 300-400 Amperes, 1200 Volts

Description:

Powerex Silicon Controlled Rectifiers (SCR) are designed for phase control applications. These are all-diffused, Press-Pak (Pow-R-Disc) devices employing the field-proven amplifying (di/namic) gate.

Features:

- Low On-State Voltage
- High di/dt
- High dv/dt
- Hermetic Packaging
- Excellent Surge and I^2t Ratings
- 150°C Junction Temperature Rating

Applications:

- Power Supplies
- Battery Chargers
- Motor Control
- Welders

Ordering Information:

Select the complete eight digit part number you desire from the table, i.e. T6251230 is a 1200 Volt, 300 Ampere Phase Control SCR.

Type	Voltage		Current	
	V_{DRM} V_{RRM}	Code	$I_{T(av)}$	Code
T625	200	02	300	30
	400	04	400	40
	600	06		
	800	08		
	1000	10		
	1200	12		

T625
Phase Control SCR
 300-400 Amperes, 1200 Volts

Absolute Maximum Ratings

	Symbol	T625 _ _ 30	T625 _ _ 40	Units
RMS On-State Current	$I_{T(RMS)}$	470	625	Amperes
Average On-State Current	$I_{T(av)}$	300	400	Amperes
Peak One-Cycle Surge (Non-Repetitive) On-State Current (60Hz)	I_{TSM}	3600	5000	Amperes
Peak One-Cycle Surge (Non-Repetitive) On-State Current (50Hz)	I_{TSM}	3300	4550	Amperes
Critical Rate-of-Rise of On-State Current (Non-Repetitive)	di/dt	800	800	Amperes/ μ s
Critical Rate-of-Rise of On-State Current (Repetitive)	di/dt	200	200	Amperes/ μ s
I^2t (for Fusing), 8.3 milliseconds	I^2t	54,000	100,000	A ² sec
Peak Gate Power Dissipation	P_{GM}	16	16	Watts
Average Gate Power Dissipation	$P_{G(av)}$	3	3	Watts
Storage Temperature	T_{STG}	-40 to 150	-40 to 150	$^{\circ}$ C
Operating Temperature	T_J	-40 to 150	-40 to 150	$^{\circ}$ C
Mounting Force		1000 to 1400	1000 to 1400	lb.
Mounting Force		450 to 635	450 to 635	kg

Electrical and Thermal Characteristics

	Symbol	Test Conditions	T625 _ _ 30	T625 _ _ 40	Units
Current—Conducting State Maximums					
Peak On-State Voltage	V_{TM}	$I_{TM} = 625A, T_J = 25^{\circ}C$	2.05	1.55	Volts
T625					
Voltage—Blocking State Maximums					
Forward Leakage, Peak	I_{DRM}	$T_J = 150^{\circ}C, V_{DRM} = \text{rated}$	50		mA
Reverse Leakage, Peak	I_{RRM}	$T_J = 150^{\circ}C, V_{RRM} = \text{rated}$	50		mA
Switching					
Typical Turn-Off Time	t_q	$I_T = 150A, T_J = 150^{\circ}C,$ $di_T/dt = 12.5A/\mu\text{sec, reapplied}$ $dv/dt = 20V/\mu\text{sec linear to } 0.8V_{DRM}$	150		μsec
Typical Turn-On Time	t_{on}	$I_T = 100A, V_D = 500V$	3		μsec
Min. Critical dv/dt exponential to V_{DRM}	dv/dt	$T_J = 150^{\circ}C$	300		V/ μsec
Thermal					
Maximum Thermal Resistance, double sided cooling					
Junction to Case	$R_{\theta JC}$		0.08		$^{\circ}C/\text{Watt}$
Case to Sink, Lubricated	$R_{\theta CS}$		0.02		$^{\circ}C/\text{Watt}$
Gate—Maximum Parameters					
Gate Current to Trigger	I_{GT}	$T_J = 25^{\circ}C, V_D = 12V$	150		mA
Gate Voltage to Trigger	V_{GT}	$T_J = 25^{\circ}C, V_D = 12V$	3		Volts
Non-Triggering Gate Voltage	V_{GDM}	$T_J = 150^{\circ}C, \text{rated } V_{DRM}$	0.25		Volts
Peak Forward Gate Current	I_{GTM}		4		Amperes
Peak Reverse Gate Voltage	V_{GRM}		5		Volts

T625
Phase Control SCR
 300-400 Amperes, 1200 Volts

MAXIMUM ON-STATE CHARACTERISTICS

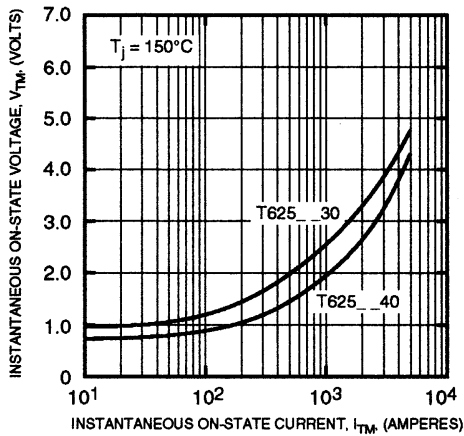

TRANSIENT THERMAL IMPEDANCE CHARACTERISTICS (JUNCTION TO CASE)

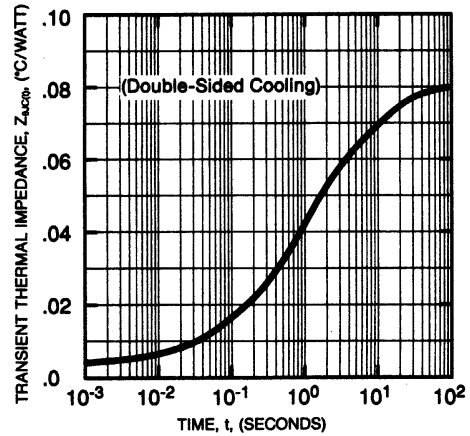

MAXIMUM ALLOWABLE CASE TEMPERATURE (SINUSOIDAL WAVEFORM)

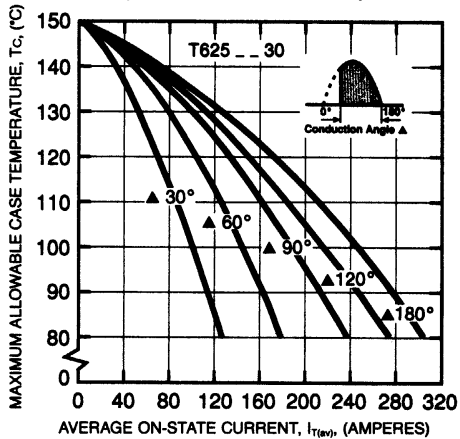

MAXIMUM ON-STATE POWER DISSIPATION (SINUSOIDAL WAVEFORM)

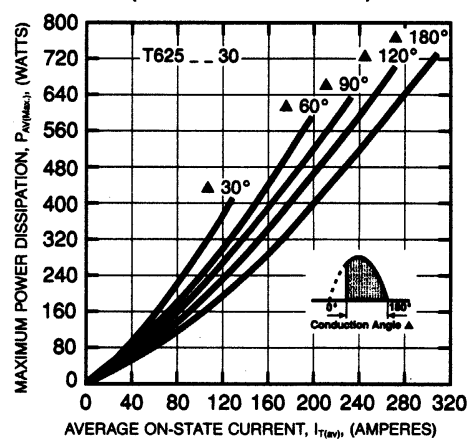

MAXIMUM ALLOWABLE CASE TEMPERATURE (RECTANGULAR WAVEFORM)

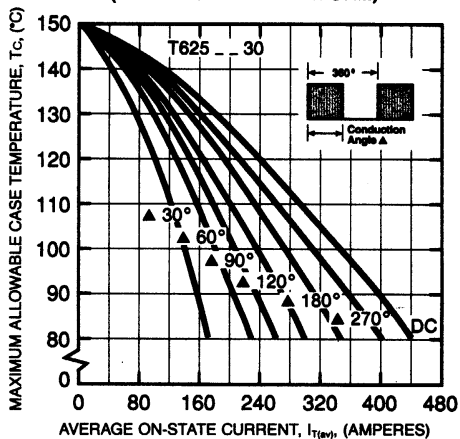

MAXIMUM ON-STATE POWER DISSIPATION (RECTANGULAR WAVEFORM)

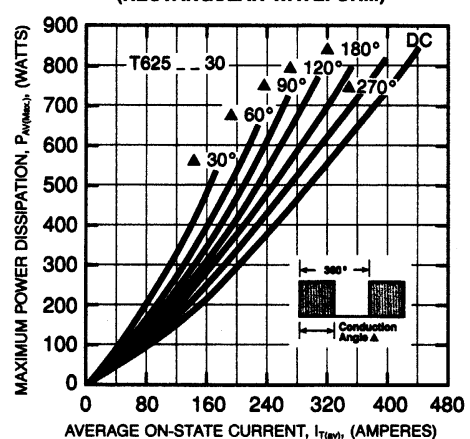

Powerex, Inc., 200 Hillis Street, Youngwood, Pennsylvania 15697-1800 (412) 925-7272
 Powerex, Europe, S.A. 428 Avenue G. Durand, BP107, 72003 Le Mans, France (43) 41.14.14

T625
Phase Control SCR
 300-400 Amperes, 1200 Volts

