

Overview

The KEMET T499 Series is a high-temperature product that offers optimum performance characteristics in applications with operating temperatures up to 175°C. Advanced materials and testing allow this series to perform with a reliability level of 0.5%/1,000 hours at rated voltage and temperature. This series is available in five standard EIA case sizes with RoHS Compliant terminations as standard.

Benefits

- Meets or exceeds EIA Standard 535BAAC
- Taped and reeled per EIA 481-1
- Symmetrical, compliant terminations
- Optional gold-plated terminations
- Laser-marked case
- 100% surge current testing
- Complies with AEC-Q200
- Capacitance values of 0.15 µF to 220 µF
- Tolerances of ±10% and ±20%
- Voltage rating of 6 to 50 VDC
- 100% steady-state accelerated aging
- Voltage derating is 1/2 at 175°C
- RoHS Compliant and lead-free terminations standard
- Operating temperature range of -55°C to +175°C

Applications

Typical applications include decoupling and filtering in industrial and automotive end applications, such as DC/DC converters, portable electronics, telecommunications, and control units operating at temperatures up to 175°C.



Environmental Compliance

RoHS Compliant (6/6) according to Directive 2002/95/EC when ordered with 100% Sn solder.



RoHS Compliant

SPICE

For a detailed analysis of specific part numbers, please visit www.kemet.com for a free download of KEMET's SPICE software. The KEMET SPICE program is freeware intended to aid design engineers in analyzing the performance of these capacitors over frequency, temperature, ripple, and DC bias conditions.

Ordering Information

T	499	X	227	M	010	A	T	E800	
Capacitor Class	Series	Case Size	Capacitance Code (pF)	Capacitance Tolerance	Voltage	Failure Rate/Design	Lead Material	ESR	Packaging (C-Spec)
T = Tantalum	High Temperature 175°C	A, B, C, D, X	First two digits represent significant figures. Third digit specifies number of zeros.	K = ±10% M = ±20%	006 = 6.3 V 010 = 10 V 016 = 16 V 020 = 20 V 025 = 25 V 035 = 35 V 050 = 50 V	A = N/A Z = N/A	T = 100% Matte Tin (Sn) Plated G = Gold Plated	Last three digits specify ESR in mΩ. (800 = 800 mΩ)	Blank = 7" Reel 7280 = 13" Reel

Performance Characteristics

Item	Performance Characteristics
Operating Temperature	-55°C to 175°C
Rated Capacitance Range	0.15 – 220 μF @ 120 Hz/25°C
Capacitance Tolerance	K Tolerance (10%), M Tolerance (20%)
Rated Voltage Range	6 – 50 V
DF (120 Hz)	Refer to Part Number Electrical Specification Table
ESR (100 kHz)	Refer to Part Number Electrical Specification Table
Leakage Current	≤ 0.01 CV (μA) at rated voltage after 5 minutes

Qualification

Test	Condition	Characteristics				
Endurance	175°C @ 1/2 rated voltage, 2,000 hours	Δ C/C	Within ±10% of initial value			
		DF	Within initial limits			
		DCL	Within 1.25 x initial limit			
		ESR	Within initial limits			
Storage Life	175°C @ 0 volts, 2,000 hours	Δ C/C	Within ±10% of initial value			
		DF	Within initial limits			
		DCL	Within 1.25 x initial limit			
		ESR	Within initial limits			
Thermal Shock	MIL–STD–202, Method 107, Condition B, mounted, -55°C to 150°C, 1,000 cycles	Δ C/C	Within ±5% of initial value			
		DF	Within initial limits			
		DCL	Within 1.25 x initial limit			
		ESR	Within initial limits			
Temperature Stability	Extreme temperature exposure at a succession of continuous steps at +25°C, -55°C, +25°C, +85°C, +150°C, +25°C	+25°C	-55°C	+85°C	+175°C	
		Δ C/C	IL*	±10%	±10%	±30%
		DF	IL	IL	1.5 x IL	1.5 x IL
Surge Voltage	25°C and 85°C, 1.32 x rated voltage 1,000 cycles (150°C, 1.2 x rated voltage)	DCL	IL			
		ESR	n/a			
		DCL	10 x IL			
Mechanical Shock/Vibration	MIL–STD–202, Method 213, Condition I, 100 G peak MIL–STD–202, Method 204, Condition D, 10 Hz to 2,000 Hz, 20 G peak	Δ C/C	Within ±10% of initial value			
		DF	Within initial limits			
		DCL	Within initial limits			

*IL = Initial Limit

Electrical Characteristics

ESR vs. Frequency

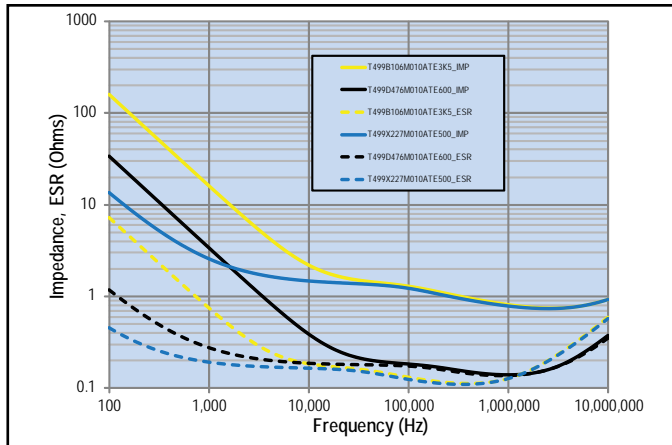

Capacitance vs. Frequency

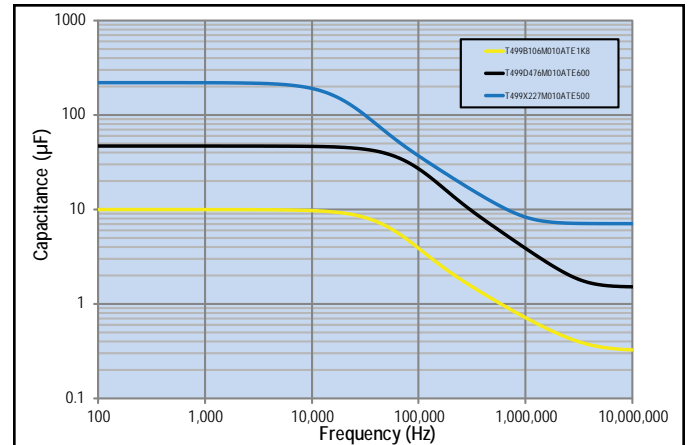

Dimensions – Millimeters (Inches)

Metric will govern

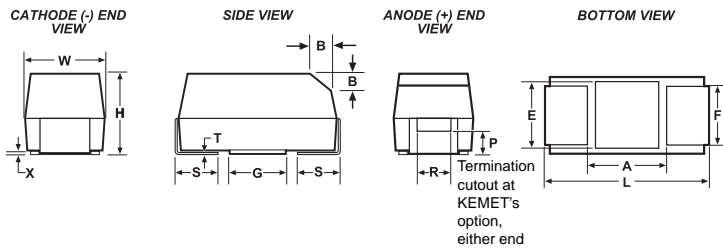

Case Size		Component												
KEMET	EIA	L*	W*	H*	F* ±0.1 ±(.004)	S* ±0.3 ±(.012)	B* ±0.15 (Ref) ±.006	X (Ref)	P (Ref)	R (Ref)	T (Ref)	A (Min)	G (Ref)	E (Ref)
A	3216-18	3.2 ± 0.2 (.126 ± .008)	1.6 ± 0.2 (.063 ± .008)	1.6 ± 0.2 (.063 ± .008)	1.2 (.047)	0.8 (.031)	0.4 (.016)	0.10 ± 0.10 (.004 ± .004)	0.4 (.016)	0.4 (.016)	0.13 (.005)	0.8 (.31)	1.1 (.043)	1.3 (.051)
B	3528-21	3.5 ± 0.2 (.138 ± .008)	2.8 ± 0.2 (.110 ± .008)	1.9 ± 0.2 (.075 ± .008)	2.2 (.087)	0.8 (.031)	0.4 (.016)	0.10 ± 0.10 (.004 ± .004)	0.5 (.020)	1.0 (.039)	0.13 (.005)	1.1 (0.043)	1.8 (.071)	2.2 (.087)
C	6032-28	6.0 ± 0.3 (.236 ± .03)	3.2 ± 0.3 (.126 ± .012)	2.5 ± 0.3 (.098 ± .012)	2.2 (.087)	1.3 (.051)	0.5 (.020)	0.10 ± 0.10 (.004 ± .004)	0.9 (.035)	1.0 (.039)	0.13 (.005)	2.5 (.098)	2.8 (.110)	2.4 (.094)
D	7343-31	7.3 ± 0.3 (.287 ± .012)	4.3 ± 0.3 (.169 ± .012)	2.8 ± 0.3 (.110 ± .012)	2.4 (.094)	1.3 (.051)	0.5 (.020)	0.10 ± 0.10 (.004 ± .004)	0.9 (.035)	1.0 (.039)	0.13 (.005)	3.8 (.150)	3.5 (.138)	3.5 (.138)
X	7343-43	7.3 ± 0.3 (.287 ± .012)	4.3 ± 0.3 (.169 ± .012)	4.0 ± 0.3 (.157 ± .012)	2.4 (.094)	1.3 (.051)	0.5 (.020)	0.10 ± 0.10 (.004 ± .004)	1.7 (.067)	1.0 (.039)	0.13 (.005)	3.8 (.150)	3.5 (.138)	3.5 (.138)

Notes: (Ref) – Dimensions provided for reference only. No dimensions provided for B, P or R because low profile cases do not have a bevel or a notch.

* MIL-PRF-55365/8 specified dimensions

Table 1 – Ratings & Part Number Reference

Rated Voltage	Rated Cap	Case Code/ Case Size	KEMET Part Number	DC Leakage	DF	ESR	Maximum Allowable Ripple Current			Moisture Sensitivity
VDC	μF	KEMET/EIA	(See below for part options)	μAmps +20°C Max/5 Min	% @ +20°C 120 Hz Max	mΩ @ 20°C 100 kHz Max	(mA) 100 kHz 25°C	(mA) 100 kHz +85°C	(mA) 100 kHz +125°C	Reflow Temp ≤ 260°C
6.3	2.2	A/3216-18	T499A225(1)006A(2)E6K5	0.1	6	6500	107	96	43	1
6.3	3.3	A/3216-18	T499A335(1)006A(2)E8K0	0.2	6	8000	97	87	39	1
6.3	4.7	A/3216-18	T499A475(1)006A(2)E6K0	0.3	6	6000	112	101	45	1
6.3	6.8	A/3216-18	T499A685(1)006A(2)E6K0	0.4	6	6000	112	101	45	1
6.3	6.8	B/3528-21	T499B685(1)006A(2)E3K5	0.4	6	3500	156	140	62	1
6.3	10	B/3528-21	T499B106(1)006A(2)E3K5	0.6	6	3500	156	140	62	1
6.3	15	B/3528-21	T499B156(1)006A(2)E3K5	0.9	6	3500	156	140	62	1
6.3	15	C/6032-28	T499C156(1)006A(2)E1K8	0.9	6	1800	247	222	99	1
6.3	22	B/3528-21	T499B226(1)006A(2)E3K5	1.4	6	3500	156	140	62	1
6.3	22	C/6032-28	T499C226(1)006A(2)E1K8	1.4	6	1800	247	222	99	1
6.3	33	B/3528-21	T499B336(1)006A(2)E3K0	2.1	6	3000	168	151	67	1
6.3	33	C/6032-28	T499C336(1)006A(2)E1K8	2.1	6	1800	247	222	99	1
6.3	47	C/6032-28	T499C476(1)006A(2)E1K8	3.0	6	1800	247	222	99	1
6.3	47	D/7343-31	T499D476(1)006A(2)E800	3.0	6	800	433	390	173	1
6.3	68	C/6032-28	T499C686(1)006A(2)E1K2	4.3	6	1200	303	273	121	1
6.3	68	D/7343-31	T499D686(1)006A(2)E800	4.3	6	800	433	390	173	1
6.3	100	D/7343-31	T499D107(1)006A(2)E800	6.3	8	800	433	390	173	1
6.3	150	D/7343-31	T499D157(1)006A(2)E700	9.5	8	700	463	417	185	1
10	1.5	A/3216-18	T499A155(1)010A(2)E8K0	0.2	6	8000	97	87	39	1
10	2.2	A/3216-18	T499A225(1)010A(2)E8K0	0.2	6	8000	97	87	39	1
10	3.3	A/3216-18	T499A335(1)010A(2)E6K0	0.3	6	6000	112	101	45	1
10	4.7	A/3216-18	T499A475(1)010A(2)E6K0	0.5	6	6000	112	101	45	1
10	4.7	B/3528-21	T499B475(1)010A(2)E3K5	0.5	6	3500	156	140	62	1
10	6.8	A/3216-18	T499A685(1)010A(2)E6K0	0.7	6	6000	112	101	45	1
10	6.8	B/3528-21	T499B685(1)010A(2)E3K5	0.7	6	3500	156	140	62	1
10	10	B/3528-21	T499B106(1)010A(2)E3K5	1.0	6	3500	156	140	62	1
10	10	C/6032-28	T499C106(1)010A(2)E1K8	1.0	6	1800	247	222	99	1
10	15	B/3528-21	T499B156(1)010A(2)E3K5	1.5	6	3500	156	140	62	1
10	15	C/6032-28	T499C156(1)010A(2)E1K8	1.5	6	1800	247	222	99	1
10	22	B/3528-21	T499B226(1)010A(2)E3K0	2.2	6	3000	168	151	67	1
10	22	C/6032-28	T499C226(1)010A(2)E1K8	2.2	6	1800	247	222	99	1
10	33	C/6032-28	T499C336(1)010A(2)E1K8	3.3	6	1800	247	222	99	1
10	33	D/7343-31	T499D336(1)010A(2)E1K6	3.3	6	1600	306	275	122	1
10	47	D/7343-31	T499D476(1)010A(2)E800	4.7	6	800	433	390	173	1
10	68	D/7343-31	T499D686(1)010A(2)E1K0	6.8	6	1000	387	348	155	1
10	68	D/7343-31	T499D686(1)010A(2)E800	6.8	6	800	433	390	173	1
10	68	D/7343-31	T499D686(1)010A(2)E600	6.8	6	600	500	450	200	1
10	100	D/7343-31	T499D107(1)010A(2)E700	10.0	8	700	463	417	185	1
10	220	X/7343-43	T499X227(1)010A(2)E250	22.0	8	250	812	731	325	1
10	220	X/7343-43	T499X227(1)010A(2)E500	22.0	8	500	574	517	230	1
16	1	A/3216-18	T499A105(1)016A(2)E10K	0.2	4	10000	87	78	35	1
16	1.5	A/3216-18	T499A155(1)016A(2)E8K0	0.2	6	8000	97	87	39	1
16	2.2	A/3216-18	T499A225(1)016A(2)E6K0	0.4	6	6000	112	101	45	1
16	3.3	A/3216-18	T499A335(1)016A(2)E500	0.5	6	500	387	348	155	1
16	3.3	B/3528-21	T499B335(1)016A(2)E3K5	0.5	6	3500	156	140	62	1
16	4.7	B/3528-21	T499B475(1)016A(2)E6K0	0.8	6	6000	119	107	48	1
16	6.8	A/3216-18	T499A685(1)016A(2)E7K0	1.1	6	7000	104	94	42	1
16	6.8	B/3528-21	T499B685(1)016A(2)E3K5	1.1	6	3500	156	140	62	1
16	6.8	C/6032-28	T499C685(1)016A(2)E1K8	1.1	6	1800	247	222	99	1
16	10	B/3528-21	T499B106(1)016A(2)E3K5	1.6	6	3500	156	140	62	1
16	10	C/6032-28	T499C106(1)016A(2)E1K8	1.6	6	1800	247	222	99	1
VDC	μF	KEMET/EIA	(See below for part options)	μAmps +20°C Max/5 Min	% @ +20°C 120 Hz Max	mΩ @ 20°C 100 kHz Max	(mA) 100 kHz 25°C	(mA) 100 kHz +85°C	(mA) 100 kHz +125°C	Reflow Temp ≤ 260°C
Rated Voltage	Rated Cap	Case Code/ Case Size	KEMET Part Number	DC Leakage	DF	ESR	Maximum Allowable Ripple Current			Moisture Sensitivity

(1) To complete KEMET part number, insert M for ±20% or K for ±10%. Designates capacitance tolerance.

(2) To complete KEMET part number, insert T = 100% Matte Tin (Sn) Plated, G = Gold Plated. Designates termination finish.

Refer to Ordering Information for additional detail.

Higher voltage ratings and tighter tolerance product including ESR may be substituted within the same size at KEMET's option. Voltage substitution will be marked with the higher voltage rating. Substitutions can include better than series.

Table 1 – Ratings & Part Number Reference cont'd

Rated Voltage	Rated Cap	Case Code/ Case Size	KEMET Part Number	DC Leakage	DF	ESR	Maximum Allowable Ripple Current			Moisture Sensitivity
VDC	μF	KEMET/EIA	(See below for part options)	μAmps +20°C Max/5 Min	% @ +20°C 120 Hz Max	mΩ @ 20°C 100 kHz Max	(mA) 100 kHz 25°C	(mA) 100 kHz +85°C	(mA) 100 kHz +125°C	Reflow Temp ≤ 260°C
16	15	C/6032-28	T499C156(1)016A(2)E1K8	2.4	6	1800	247	222	99	1
16	22	C/6032-28	T499C226(1)016A(2)E1K6	3.5	6	1600	262	236	105	1
16	22	D/7343-31	T499D226(1)016A(2)E800	3.5	6	800	433	390	173	1
16	33	D/7343-31	T499D336(1)016A(2)E800	5.3	6	800	433	390	173	1
16	47	D/7343-31	T499D476(1)016A(2)E800	7.5	6	800	433	390	173	1
20	0.68	A/3216-18	T499A684(1)020A(2)E12K	0.1	4	12000	79	71	32	1
20	1	A/3216-18	T499A105(1)020A(2)E10K	0.2	4	10000	87	78	35	1
20	1.5	A/3216-18	T499A155(1)020A(2)E8K0	0.3	6	8000	97	87	39	1
20	2.2	B/3528-21	T499B225(1)020A(2)E3K5	0.4	6	3500	156	140	62	1
20	3.3	B/3528-21	T499B335(1)020A(2)E3K5	0.7	6	3500	156	140	62	1
20	4.7	B/3528-21	T499B475(1)020A(2)E3K5	0.9	6	3500	156	140	62	1
20	4.7	C/6032-28	T499C475(1)020A(2)E2K4	0.9	6	2400	214	193	86	1
20	6.8	C/6032-28	T499C685(1)020A(2)E1K9	1.4	6	1900	241	217	96	1
20	10	C/6032-28	T499C106(1)020A(2)E1K8	2.0	6	1800	247	222	99	1
20	15	C/6032-28	T499C156(1)020A(2)E1K7	3.0	6	1700	254	229	102	1
20	15	D/7343-31	T499D156(1)020A(2)E1K0	3.0	6	1000	387	348	155	1
20	22	D/7343-31	T499D226(1)020A(2)E800	4.4	6	800	433	390	173	1
25	0.47	A/3216-18	T499A474(1)025A(2)E14K	0.1	4	14000	73	66	29	1
25	0.68	A/3216-18	T499A684(1)025A(2)E10K	0.2	4	10000	87	78	35	1
25	1	A/3216-18	T499A105(1)025A(2)E8K0	0.3	4	8000	97	87	39	1
25	1.5	B/3528-21	T499B155(1)025A(2)E5K0	0.4	6	5000	130	117	52	1
25	2.2	B/3528-21	T499B225(1)025A(2)E4K5	0.6	6	4500	137	123	55	1
25	3.3	C/6032-28	T499C335(1)025A(2)E2K5	0.8	6	2500	210	189	84	1
25	4.7	C/6032-28	T499C475(1)025A(2)E2K4	1.2	6	2400	214	193	86	1
25	6.8	C/6032-28	T499C685(1)025A(2)E1K9	1.7	6	1900	241	217	96	1
25	6.8	D/7343-31	T499D685(1)025A(2)E1K1	1.7	6	1100	369	332	148	1
25	10	C/6032-28	T499C106(1)025A(2)E1K5	2.5	6	1500	271	244	108	1
25	10	D/7343-31	T499D106(1)025A(2)E1K0	2.5	6	1000	387	348	155	1
25	15	D/7343-31	T499D156(1)025A(2)E1K0	3.8	6	1000	387	348	155	1
25	22	D/7343-31	T499D226(1)025A(2)E800	5.5	6	800	433	390	173	1
25	33	D/7343-31	T499D336(1)025A(2)E700	8.3	6	700	463	417	185	1
35	0.15	A/3216-18	T499A154(1)035A(2)E19K	0.1	4	19000	63	57	25	1
35	0.22	A/3216-18	T499A224(1)035A(2)E18K	0.1	4	18000	65	59	26	1
35	0.33	A/3216-18	T499A334(1)035A(2)E15K	0.1	4	15000	71	64	28	1
35	0.47	B/3528-21	T499B474(1)035A(2)E8K0	0.2	4	8000	103	93	41	1
35	0.68	B/3528-21	T499B684(1)035A(2)E6K5	0.2	4	6000	119	107	48	1
35	1	A/3216-18	T499A105(1)035A(2)E10K	0.4	4	10000	87	78	35	1
35	1	B/3528-21	T499B105(1)035A(2)E5K0	0.4	4	5000	130	117	52	1
35	1.5	C/6032-28	T499C155(1)035A(2)E4K5	0.5	6	4500	156	140	62	1
35	2.2	C/6032-28	T499C225(1)035A(2)E3K5	0.8	6	3500	177	159	71	1
35	3.3	C/6032-28	T499C335(1)035A(2)E2K5	1.2	6	2500	210	189	84	1
35	4.7	C/6032-28	T499C475(1)035A(2)E2K5	1.6	6	2500	210	189	84	1
35	4.7	D/7343-31	T499D475(1)035A(2)E1K0	1.6	6	1000	387	348	155	1
35	4.7	D/7343-31	T499D475(1)035A(2)E1K5	1.6	6	1500	316	284	126	1
35	6.8	D/7343-31	T499D685(1)035A(2)E1K3	2.4	6	1300	340	306	136	1
35	10	D/7343-31	T499D106(1)035A(2)E1K0	3.5	6	1000	387	348	155	1
35	22	X/7343-43	T499X226(1)035A(2)E700	7.7	6	700	486	437	194	1
35	33	X/7343-43	T499X336(1)035A(2)E600	11.6	6	600	524	472	210	1
VDC	μF	KEMET/EIA	(See below for part options)	μAmps +20°C Max/5 Min	% @ +20°C 120 Hz Max	mΩ @ 20°C 100 kHz Max	(mA) 100 kHz 25°C	(mA) 100 kHz +85°C	(mA) 100 kHz +125°C	Reflow Temp ≤ 260°C
Rated Voltage	Rated Cap	Case Code/ Case Size	KEMET Part Number	DC Leakage	DF	ESR	Maximum Allowable Ripple Current			Moisture Sensitivity

(1) To complete KEMET part number, insert M for ±20% or K for ±10%. Designates capacitance tolerance.

(2) To complete KEMET part number, insert T = 100% Matte Tin (Sn) Plated, G = Gold Plated. Designates termination finish.

Refer to Ordering Information for additional detail.

Higher voltage ratings and tighter tolerance product including ESR may be substituted within the same size at KEMET's option. Voltage substitution will be marked with the higher voltage rating. Substitutions can include better than series.

Table 1 – Ratings & Part Number Reference cont'd

Rated Voltage	Rated Cap	Case Code/ Case Size	KEMET Part Number	DC Leakage	DF	ESR	Maximum Allowable Ripple Current			Moisture Sensitivity
VDC	μF	KEMET/EIA	(See below for part options)	μAmps +20°C Max/5 Min	% @ +20°C 120 Hz Max	mΩ @ 20°C 100 kHz Max	(mA) 100 kHz 25°C	(mA) 100 kHz +85°C	(mA) 100 kHz +125°C	Reflow Temp ≤ 260°C
50	3.3	D/7343-31	T499D335(1)050A(2)E2K0	1.7	6	2000	274	247	110	1
50	10	D/7343-31	T499D106(1)050A(2)E1K0	5.0	6	1000	387	348	155	1
VDC	μF	KEMET/EIA	(See below for part options)	μAmps +20°C Max/5 Min	% @ +20°C 120 Hz Max	mΩ @ 20°C 100 kHz Max	(mA) 100 kHz 25°C	(mA) 100 kHz +85°C	(mA) 100 kHz +125°C	Reflow Temp ≤ 260°C
Rated Voltage	Rated Cap	Case Code/ Case Size	KEMET Part Number	DC Leakage	DF	ESR	Maximum Allowable Ripple Current			Moisture Sensitivity

(1) To complete KEMET part number, insert M for ±20% or K for ±10%. Designates capacitance tolerance.

(2) To complete KEMET part number, insert T = 100% Matte Tin (Sn) Plated, G = Gold Plated. Designates termination finish.

Refer to Ordering Information for additional detail.

Higher voltage ratings and tighter tolerance product including ESR may be substituted within the same size at KEMET's option. Voltage substitution will be marked with the higher voltage rating. Substitutions can include better than series.

Recommended Voltage Derating Guidelines

Rated Voltage	Working Voltage		Recommended Application Voltage (for maximum reliability)	
	85°C	175°C	85°C	175°C
6.3	6.3	3.15	3.15	1.58
10	10	5.00	5	2.50
16	16	8.00	8	4.00
20	20	10.00	10	5.00
25	25	12.50	12.5	6.25
35	35	17.50	17.5	8.75
50	50	25.00	25	12.50

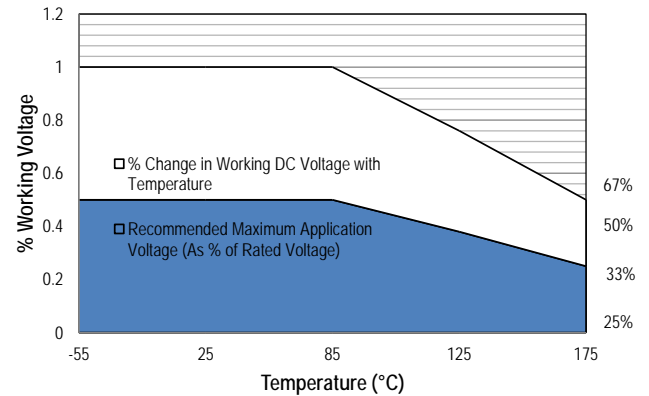

Ripple Current/Ripple Voltage

KEMET Series and Case Code	EIA Case Code	Maximum Power Dissipation (P max) mWatts @ 25°C w/+20°C Rise
A	3216-18	75
B	3528-21	85
C	6032-28	110
D	7343-31	150
X	7343-43	165
E	7360-38	200
T428P	7360-38	325
S	3216-12	60
T	3528-12	70
U	6032-15	90
V	7343-20	125
T510X	7343-43	270
T510E	7360-38	285

Temperature Compensation Multipliers for Maximum Power Dissipation				
≤ 25°C	85°C	125°C	150°C*	175°C**
1.00	0.90	0.40	0.30	0.20

T = Environmental Temperature

*T498 Only

**T499 Only

Using the P max of the device, the maximum allowable rms ripple current or voltage may be determined.

$$I(max) = \sqrt{P_{max}/R}$$

$$E(max) = \sqrt{P_{max} * R}$$

I = rms ripple current (amperes)

E = rms ripple voltage (volts)

P max = maximum power dissipation (watts)

R = ESR at specified frequency (ohms)

Reverse Voltage

Solid tantalum capacitors are polar devices and may be permanently damaged or destroyed if connected with the wrong polarity. The positive terminal is identified on the capacitor body by a stripe plus in some cases a beveled edge. A small degree of transient reverse voltage is permissible for short periods per the table. The capacitors should not be operated continuously in reverse mode, even within these limits.

Temperature	Permissible Transient Reverse Voltage
25°C	15% of Rated Voltage
85°C	5% of Rated Voltage
125°C	1% of Rated Voltage

Table 2 – Land Dimensions/Courtyard

KEMET Case	Metric Size Code EIA	Density Level A: Maximum (Most) Land Protrusion (mm)					Density Level B: Median (Nominal) Land Protrusion (mm)					Density Level C: Minimum (Least) Land Protrusion (mm)				
		X	Y	C	V1	V2	X	Y	C	V1	V2	X	Y	C	V1	V2
A	3216-18	1.35	2.15	1.45	6.10	2.80	1.25	1.75	1.35	5.00	2.30	1.15	1.35	1.25	4.10	2.00
B	3528-21	2.35	2.15	1.45	6.10	4.00	2.25	1.75	1.35	5.00	3.50	2.15	1.35	1.25	4.10	3.20
C	6032-28	2.35	2.65	2.60	8.90	4.40	2.25	2.25	2.50	7.80	3.90	2.15	1.85	2.40	6.90	3.60
D	7343-31	2.55	3.75	2.70	10.20	5.50	2.45	3.35	2.60	9.10	5.00	2.35	2.95	2.50	8.20	4.70
X ¹	7343-43	2.55	3.75	2.70	10.20	5.50	2.45	3.35	2.60	9.10	5.00	2.35	2.95	2.50	8.20	4.70

Density Level A: For low-density product applications. Recommended for wave solder applications and provides a wider process window for reflow solder processes.

Density Level B: For products with a moderate level of component density. Provides a robust solder attachment condition for reflow solder processes.

Density Level C: For high component density product applications. Before adapting the minimum land pattern variations the user should perform qualification testing based on the conditions outlined in IPC Standard 7351 (IPC-7351).

¹ Height of these chips may create problems in wave soldering.

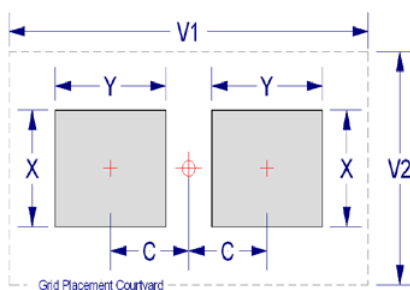

Soldering Process

KEMET's families of surface mount capacitors are compatible with wave (single or dual), convection, IR, or vapor phase reflow techniques. Preheating of these components is recommended to avoid extreme thermal stress. KEMET's recommended profile conditions for convection and IR reflow reflect the profile conditions of the IPC/J-STD-020D standard for moisture sensitivity testing. The devices can safely withstand a maximum of three reflow passes at these conditions.

Please note that although the X/7343-43 case size can withstand wave soldering, the tall profile (4.3 mm maximum) dictates care in wave process development.

Hand soldering should be performed with care due to the difficulty in process control. If performed, care should be taken to avoid contact of the soldering iron to the molded case. The iron should be used to heat the solder pad, applying solder between the pad and the termination, until reflow occurs. Once reflow occurs, the iron should be removed immediately. "Wiping" the edges of a chip and heating the top surface is not recommended.

During typical reflow operations, a slight darkening of the gold-colored epoxy may be observed. This slight darkening is normal and not harmful to the product. Marking permanency is not affected by this change.

Profile Feature	SnPb Assembly	Pb-Free Assembly
Preheat/Soak		
Temperature Minimum (T_{Smin})	100°C	150°C
Temperature Maximum (T_{Smax})	150°C	200°C
Time (t_s) from T_{Smin} to T_{Smax}	60 – 120 seconds	60 – 120 seconds
Ramp-up Rate (T_L to T_P)	3°C/seconds maximum	3°C/seconds maximum
Liquidous Temperature (T_L)	183°C	217°C
Time Above Liquidous (t_L)	60 – 150 seconds	60 – 150 seconds
Peak Temperature (T_P)	220°C* 235°C**	250°C* 260°C**
Time within 5°C of Maximum Peak Temperature (t_p)	20 seconds maximum	30 seconds maximum
Ramp-down Rate (T_P to T_L)	6°C/seconds maximum	6°C/seconds maximum
Time 25°C to Peak Temperature	6 minutes maximum	8 minutes maximum

Note: All temperatures refer to the center of the package, measured on the package body surface that is facing up during assembly reflow.

*Case Size D, E, P, Y, and X

**Case Size A, B, C, H, I, K, M, R, S, T, U, V, W, and Z

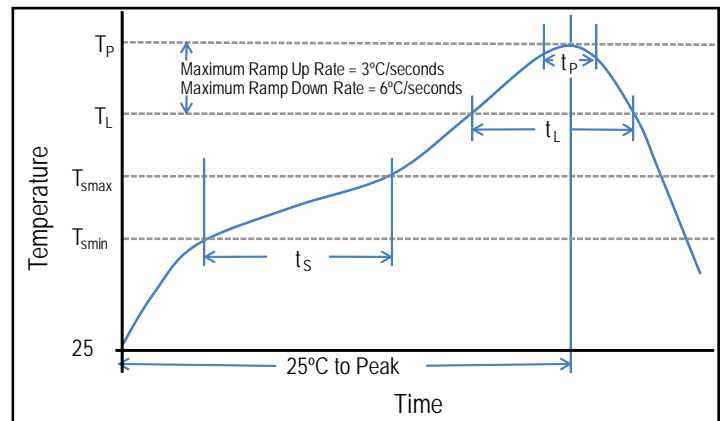

Construction

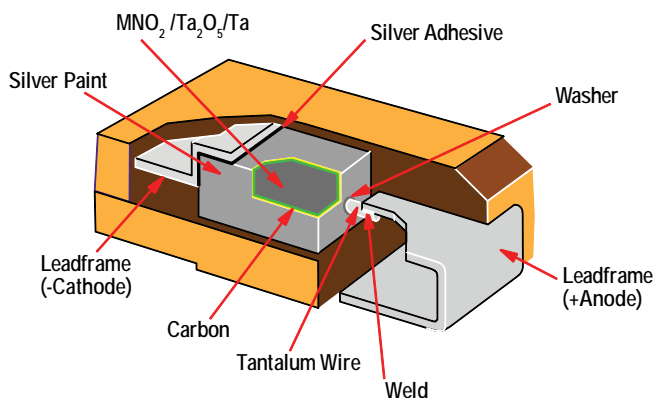

Capacitor Marking

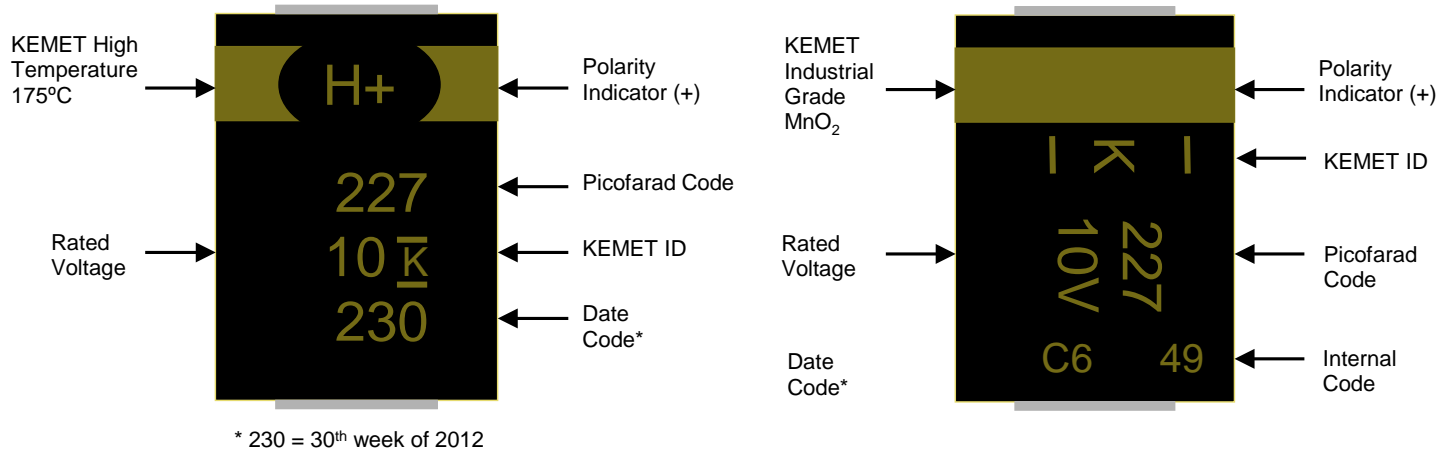

Date Code *	
1 st digit = Last number of Year	9 = 2009 0 = 2010 1 = 2011 2 = 2012
2 nd and 3 rd digit = Week of the Year	01 = 1 st week of the Year to 52 = 52 nd week of the Year

Date Code*		
Year	Month	
X = 2009	1 = Jan	7 = Jul
A = 2010	2 = Feb	8 = Aug
B = 2011	3 = Mar	9 = Spt
C = 2012	4 = Apr	O = Oct
D = 2013	5 = May	N = Nov
E = 2014	6 = Jun	D = Dec

Storage

Tantalum chip capacitors should be stored in normal working environments. While the chips themselves are quite robust in other environments, solderability will be degraded by exposure to high temperatures, high humidity, corrosive atmospheres, and long term storage. In addition, packaging materials will be degraded by high temperature— reels may soften or warp and tape peel force may increase. KEMET recommends that maximum storage temperature not exceed 40°C and maximum storage humidity not exceed 60% relative humidity. Temperature fluctuations should be minimized to avoid condensation on the parts and atmospheres should be free of chlorine and sulphur bearing compounds. For optimized solderability chip stock should be used promptly, preferably within three years of receipt.

Tape & Reel Packaging Information

KEMET's molded tantalum and aluminum chip capacitor families are packaged in 8 and 12 mm plastic tape on 7" and 13" reels in accordance with *EIA Standard 481-1: Embossed Carrier Taping of Surface Mount Components for Automatic Handling*. This packaging system is compatible with all tape-fed automatic pick-and-place systems.

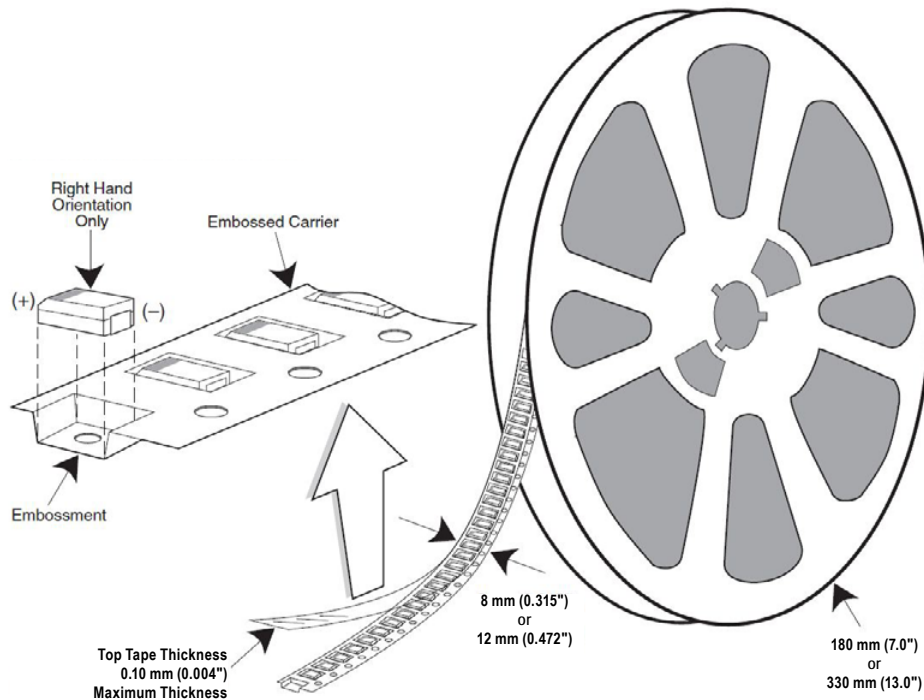

Table 3 – Packaging Quantity

Case Code		Tape Width (mm)	7" Reel*	13" Reel*
KEMET	EIA			
I	3216-10	8	3,000	12,000
S	3216-12	8	2,500	10,000
T	3528-12	8	2,500	10,000
M	3528-15	8	2,000	8,000
U	6032-15	12	1,000	5,000
L	6032-19	12	1,000	5,000
W	7343-15	12	1,000	3,000
Z	7343-17	12	1,000	3,000
V	7343-20	12	1,000	3,000
A	3216-18	8	2,000	9,000
B	3528-21	8	2,000	8,000
C	6032-28	12	500	3,000
D	7343-31	12	500	2,500
Y	7343-40	12	500	2,000
X	7343-43	12	500	2,000
E/T428P	7360-38	12	500	2,000
H	7360-20	12	1,000	2,500

* No C-Spec required for 7" reel packaging. C-7280 required for 13" reel packaging.

Figure 1 – Embossed (Plastic) Carrier Tape Dimensions

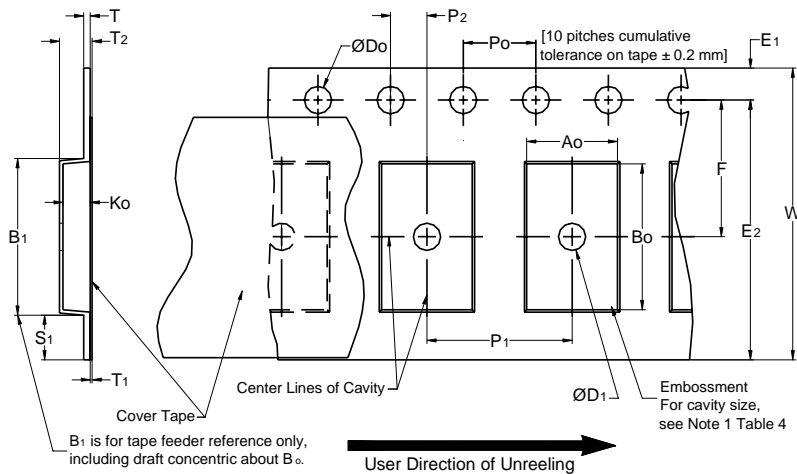

Table 4 – Embossed (Plastic) Carrier Tape Dimensions

Metric will govern

Constant Dimensions — Millimeters (Inches)									
Tape Size	D ₀	D ₁ Minimum Note 1	E ₁	P ₀	P ₂	R Reference Note 2	S ₁ Minimum Note 3	T Maximum	T ₁ Maximum
8 mm	1.5 +0.10/-0.0 (0.059 +0.004/-0.0)	1.0 (0.039)	1.75 ±0.10 (0.069 ±0.004)	4.0 ±0.10 (0.157 ±0.004)	2.0 ±0.05 (0.079 ±0.002)	25.0 (0.984)	0.600 (0.024)	0.600 (0.024)	0.100 (0.004)
12 mm		1.5 (0.059)				30 (1.181)			
16 mm									
Variable Dimensions — Millimeters (Inches)									
Tape Size	Pitch	B ₁ Maximum Note 4	E ₂ Minimum	F	P ₁	T ₂ Maximum	W Maximum	A ₀ , B ₀ & K ₀	
8 mm	Single (4 mm)	4.35 (0.171)	6.25 (0.246)	3.5 ±0.05 (0.138 ±0.002)	4.0 ±0.10 (0.157 ±0.004)	2.5 (0.098)	8.3 (0.327)	Note 5	
12 mm	Single (4 mm) & Double (8 mm)	8.2 (0.323)	10.25 (0.404)	5.5 ±0.05 (0.217 ±0.002)	8.0 ±0.10 (0.315 ±0.004)	4.6 (0.181)	12.3 (0.484)		
16 mm	Triple (12 mm)	12.1 (0.476)	14.25 (0.561)	5.5 ±0.05 (0.217 ±0.002)	8.0 ±0.10 (0.315 ±0.004)	4.6 (0.181)	16.3 (0.642)		

- The embossment hole location shall be measured from the sprocket hole controlling the location of the embossment. Dimensions of embossment location and hole location shall be applied independent of each other.
- The tape, with or without components, shall pass around R without damage (see Figure 5).
- If S₁ < 1.0 mm, there may not be enough area for cover tape to be properly applied (see EIA Standard 481–D, paragraph 4.3, section b).
- B₁ dimension is a reference dimension for tape feeder clearance only.
- The cavity defined by A₀, B₀ and K₀ shall surround the component with sufficient clearance that:
 - the component does not protrude above the top surface of the carrier tape.
 - the component can be removed from the cavity in a vertical direction without mechanical restriction, after the top cover tape has been removed.
 - rotation of the component is limited to 20° maximum for 8 and 12 mm tapes and 10° maximum for 16 mm tapes (see Figure 2).
 - lateral movement of the component is restricted to 0.5 mm maximum for 8 mm and 12 mm wide tape and to 1.0 mm maximum for 16 mm tape (see Figure 3).
 - see Addendum in EIA Standard 481–D for standards relating to more precise taping requirements.

Packaging Information Performance Notes

- 1. Cover Tape Break Force:** 1.0 Kg minimum.
- 2. Cover Tape Peel Strength:** The total peel strength of the cover tape from the carrier tape shall be:

Tape Width	Peel Strength
8 mm	0.1 to 1.0 Newton (10 to 100 gf)
12 and 16 mm	0.1 to 1.3 Newton (10 to 130 gf)

The direction of the pull shall be opposite the direction of the carrier tape travel. The pull angle of the carrier tape shall be 165° to 180° from the plane of the carrier tape. During peeling, the carrier and/or cover tape shall be pulled at a velocity of 300 ±10 mm/minute.

- 3. Labeling:** Bar code labeling (standard or custom) shall be on the side of the reel opposite the sprocket holes. Refer to EIA Standards 556 and 624.

Figure 2 – Maximum Component Rotation

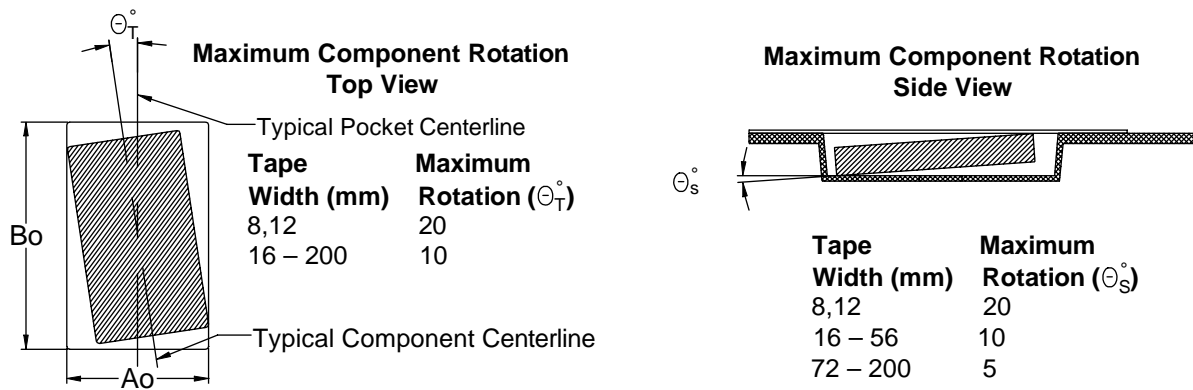

Figure 3 – Maximum Lateral Movement

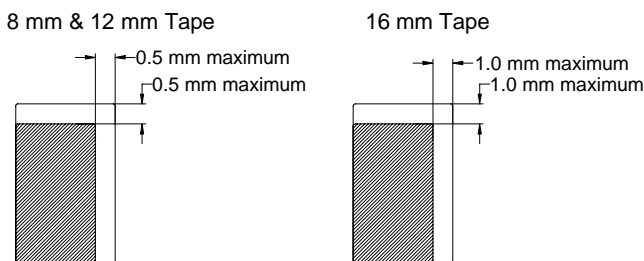

Figure 4 – Bending Radius

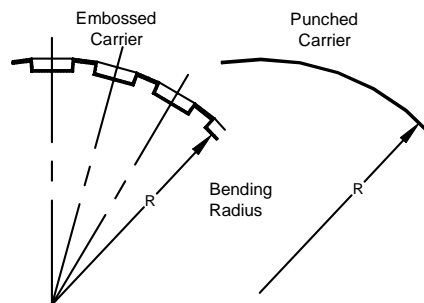
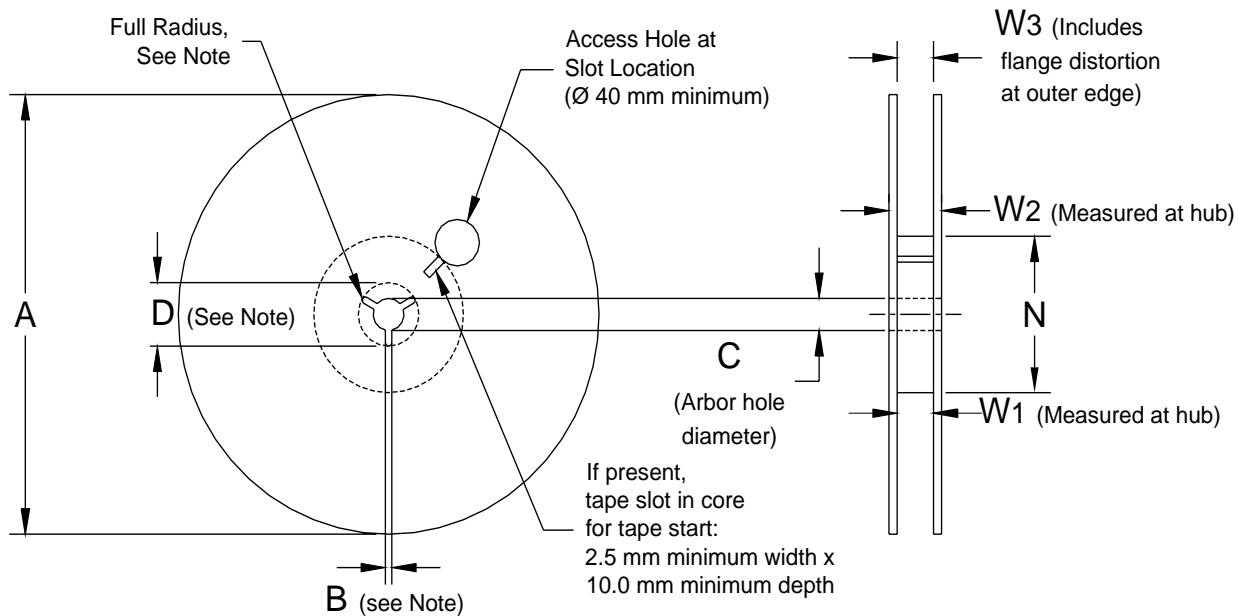

Figure 5 – Reel Dimensions



Note: Drive spokes optional; if used, dimensions B and D shall apply.

Table 5 – Reel Dimensions

Metric will govern

Constant Dimensions — Millimeters (Inches)				
Tape Size	A	B Minimum	C	D Minimum
8 mm	178 ±0.20 (7.008 ±0.008) or 330 ±0.20 (13.000 ±0.008)	1.5 (0.059)	13.0 +0.5/-0.2 (0.521 +0.02/-0.008)	20.2 (0.795)
12 mm				
16 mm				
Variable Dimensions — Millimeters (Inches)				
Tape Size	N Minimum	W ₁	W ₂ Maximum	W ₃
8 mm	50 (1.969)	8.4 +1.5/-0.0 (0.331 +0.059/-0.0)	14.4 (0.567)	Shall accommodate tape width without interference
12 mm		12.4 +2.0/-0.0 (0.488 +0.078/-0.0)	18.4 (0.724)	
16 mm		16.4 +2.0/-0.0 (0.646 +0.078/-0.0)	22.4 (0.882)	

Figure 6 – Tape Leader & Trailer Dimensions

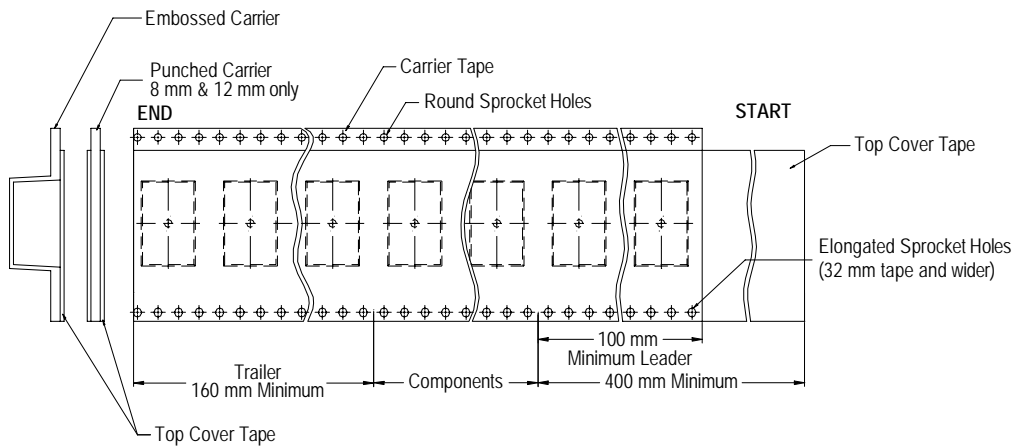
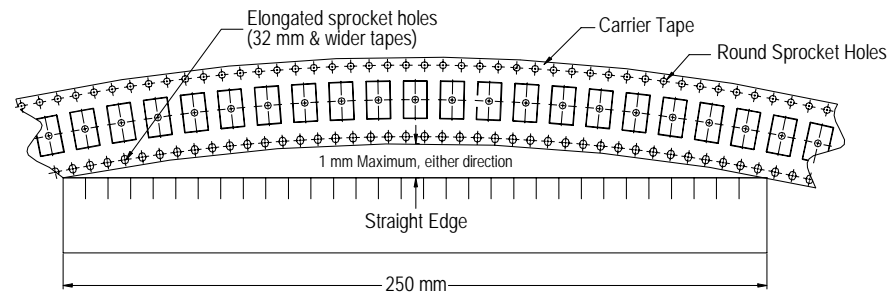

Figure 7 – Maximum Camber



KEMET Corporation World Headquarters

2835 KEMET Way
Simpsonville, SC 29681

Mailing Address:
P.O. Box 5928
Greenville, SC 29606

www.kemet.com
Tel: 864-963-6300
Fax: 864-963-6521

Corporate Offices
Fort Lauderdale, FL
Tel: 954-766-2800

North America

Southeast
Lake Mary, FL
Tel: 407-855-8886

Northeast
Wilmington, MA
Tel: 978-658-1663

Central
Novi, MI
Tel: 248-994-1030

West
Milpitas, CA
Tel: 408-433-9950

Mexico
Guadalajara, Jalisco
Tel: 52-33-3123-2141

Europe

Southern Europe
Paris, France
Tel: 33-1-4646-1006

Sasso Marconi, Italy
Tel: 39-051-939111

Central Europe
Landsberg, Germany
Tel: 49-8191-3350800

Kamen, Germany
Tel: 49-2307-438110

Northern Europe
Bishop's Stortford, United Kingdom
Tel: 44-1279-460122

Espoo, Finland
Tel: 358-9-5406-5000

Asia

Northeast Asia
Hong Kong
Tel: 852-2305-1168

Shenzhen, China
Tel: 86-755-2518-1306

Beijing, China
Tel: 86-10-5829-1711

Shanghai, China
Tel: 86-21-6447-0707

Taipei, Taiwan
Tel: 886-2-27528585

Southeast Asia
Singapore
Tel: 65-6586-1900

Penang, Malaysia
Tel: 60-4-6430200

Bangalore, India
Tel: 91-806-53-76817

Note: KEMET reserves the right to modify minor details of internal and external construction at any time in the interest of product improvement. KEMET does not assume any responsibility for infringement that might result from the use of KEMET Capacitors in potential circuit designs. KEMET is a registered trademark of KEMET Electronics Corporation.

Other KEMET Resources

Tools	
Resource	Location
Configure A Part: CapEdge	http://capacitoredge.kemet.com
SPICE & FIT Software	http://www.kemet.com/spice
Search Our FAQs: KnowledgeEdge	http://www.kemet.com/keask
Electrolytic LifeCalculator	http://www.kemet.com:8080/elc

Product Information	
Resource	Location
Products	http://www.kemet.com/products
Technical Resources (Including Soldering Techniques)	http://www.kemet.com/technicalpapers
RoHS Statement	http://www.kemet.com/rohs
Quality Documents	http://www.kemet.com/qualitydocuments

Product Request	
Resource	Location
Sample Request	http://www.kemet.com/sample
Engineering Kit Request	http://www.kemet.com/kits

Contact	
Resource	Location
Website	www.kemet.com
Contact Us	http://www.kemet.com/contact
Investor Relations	http://www.kemet.com/ir
Call Us	1-877-MyKEMET
Twitter	http://twitter.com/kemetcapacitors

Disclaimer

All product specifications, statements, information and data (collectively, the "Information") are subject to change without notice.

All Information given herein is believed to be accurate and reliable, but is presented without guarantee, warranty, or responsibility of any kind, expressed or implied.

Statements of suitability for certain applications are based on our knowledge of typical operating conditions for such applications, but are not intended to constitute – and we specifically disclaim – any warranty concerning suitability for a specific customer application or use. This Information is intended for use only by customers who have the requisite experience and capability to determine the correct products for their application. Any technical advice inferred from this Information or otherwise provided by us with reference to the use of our products is given gratis, and we assume no obligation or liability for the advice given or results obtained.

Although we design and manufacture our products to the most stringent quality and safety standards, given the current state of the art, isolated component failures may still occur. Accordingly, customer applications which require a high degree of reliability or safety should employ suitable designs or other safeguards (such as installation of protective circuitry or redundancies) in order to ensure that the failure of an electrical component does not result in a risk of personal injury or property damage.

Although all product-related warnings, cautions and notes must be observed, the customer should not assume that all safety measures are indicated or that other measures may not be required.

