

KEMET Part Number: T322B105K050AT7200
(T322B105K050AT7241, T322B105K050ATTR)

T322, Tantalum, MnO2 Tantalum, Commercial Grade, 1 uF, 10%, 50 VDC, 8 Ohms

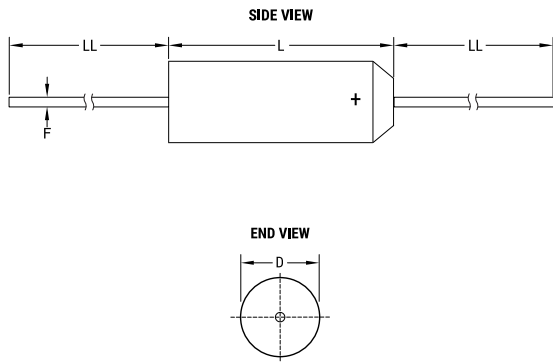

Dimensions

D	2.79mm MAX
L	7.37mm MAX
LL	38.1mm +/-6.35mm
F	0.51mm +/-0.05mm

Packaging Specifications

Packaging:	T&R, 305mm, Class I, B = 52.4mm
Packaging Quantity:	1000

General Information

Supplier:	KEMET
Series:	T322
Dielectric:	MnO2 Tantalum
Style:	Axial
Description:	Axial, Solid Tantalum, Molded, Military (Non-ER), Low ESR
Features:	Low ESR
RoHS:	Yes
Termination:	Tin
Lead:	Wire Leads
Notes:	Uninsulated
Shelf Life:	156 Weeks

Specifications

Capacitance:	1 uF
Capacitance Tolerance:	10%
Voltage DC:	50 VDC (85C), 33.35 VDC (125C Surge), 0.5 VDC (125C Reverse)
Temperature Range:	-55/+125C
Rated Temperature:	85C
Resistance:	8 Ohms (100kHz)
Leakage Current:	0.5 uA (25C)