

KEMET Part Number: T110B335M035AS
(CS13BF335M)

T110, Tantalum, MnO2 Tantalum, Commercial Grade, 3.3 uF, 20%, 35 VDC, 4 Ohms

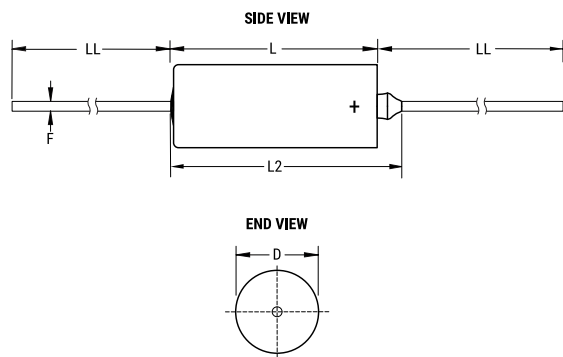

Dimensions	
D	4.7mm +/-0.25mm
L	12.04mm +/-0.79mm
L2	15.49mm
LL	38.1mm +/-6.35mm
F	0.51mm +/-0.05mm

Packaging Specifications	
Packaging:	Bulk, Box
Packaging Quantity:	75

General Information	
Supplier:	KEMET
Series:	T110
Dielectric:	MnO2 Tantalum
Style:	Axial Hermetic
Description:	Axial, Solid Tantalum, Hermetically Sealed, Military (Non-ER), Polar
Features:	Polar
RoHS:	No
Prop 65:	⚠ WARNING: Cancer and reproductive harm - www.p65warnings.ca.gov
REACH:	SVHC (Pb – CAS 7439-92-1)
Termination:	Lead (SnPb)
Lead:	Wire Leads
Construction:	Hermetic
Notes:	Dimensions Include Insulation Sleeve. When Supplied On T&R Or Ammo, Lead Length Is Determined By Taping Specification

Specifications	
Capacitance:	3.3 uF
Capacitance Tolerance:	20%
Voltage DC:	35 VDC (85C), 28 VDC (125C Surge), 0.35 VDC (125C Reverse)
Temperature Range:	-55/+125C
Rated Temperature:	85C
Resistance:	4 Ohms (100kHz)
Leakage Current:	1 uA (25C)