

T110, Tantalum, MnO2 Tantalum, Commercial Grade, 4.7 uF, 10%, 10 VDC, 8 Ohms

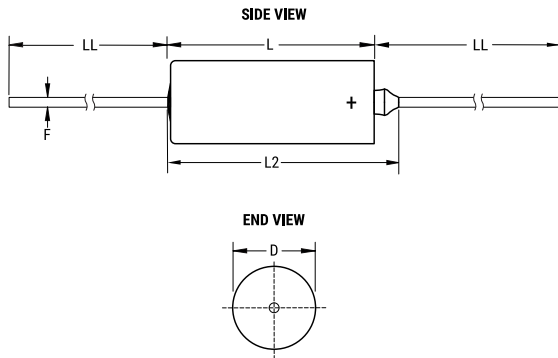

Dimensions	
D	3.43mm +/-0.25mm
L	7.26mm +/-0.79mm
L2	10.72mm
LL	38.1mm +/-6.35mm
F	0.51mm +/-0.05mm

Packaging Specifications	
Packaging:	Bulk, Box
Packaging Quantity:	150

General Information	
Supplier:	KEMET
Series:	T110
Dielectric:	MnO2 Tantalum
Style:	Axial Hermetic
Description:	Axial, Solid Tantalum, Hermetically Sealed, Military (Non-ER), Polar
Features:	Polar
RoHS:	Yes
Termination:	Tin
Lead:	Wire Leads
Construction:	Hermetic
Notes:	Dimensions Include Insulation Sleeve. When Supplied On T&R Or Ammo, Lead Length Is Determined By Taping Specification

Specifications	
Capacitance:	4.7 uF
Capacitance Tolerance:	10%
Voltage DC:	10 VDC (85C), 9 VDC (125C Surge), 0.1 VDC (125C Reverse)
Temperature Range:	-55/+125C
Rated Temperature:	85C
Resistance:	8 Ohms (100kHz)
Leakage Current:	0.4 uA (25C)