

THIS DOCUMENT IS SUBJECT TO CHANGE WITHOUT NOTICE. IT IS CONFIDENTIAL AND A PROPERTY OF Amphenol LTW. DISCLOSURE TO THIRD PARTY HAS TO BE AUTHORIZED BY Amphenol LTW.

REV.	ECN NO.	DATE	SIGN	DESCRIPTION
A	Initial Release	2012-12-06	Fisher	Initial Release
B	LEN1310207	2013-02-20	Fisher	Change Plating and PCB Layout
C	LE313C0108	2013-12-16	Fisher	Change Plating and Package

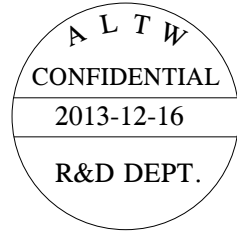
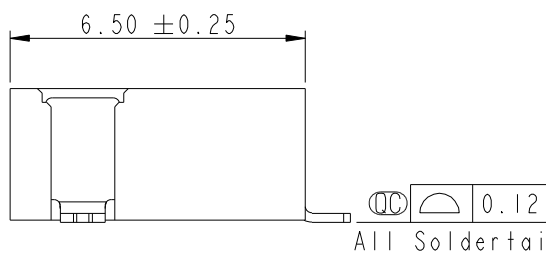
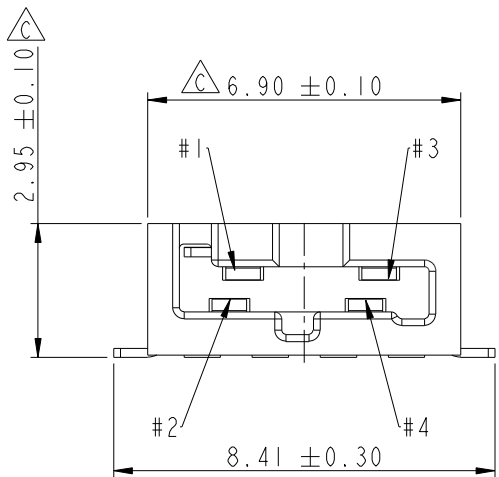
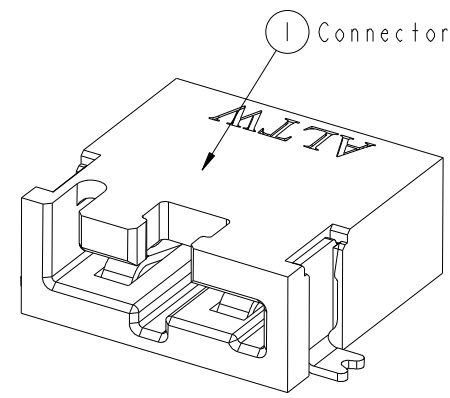
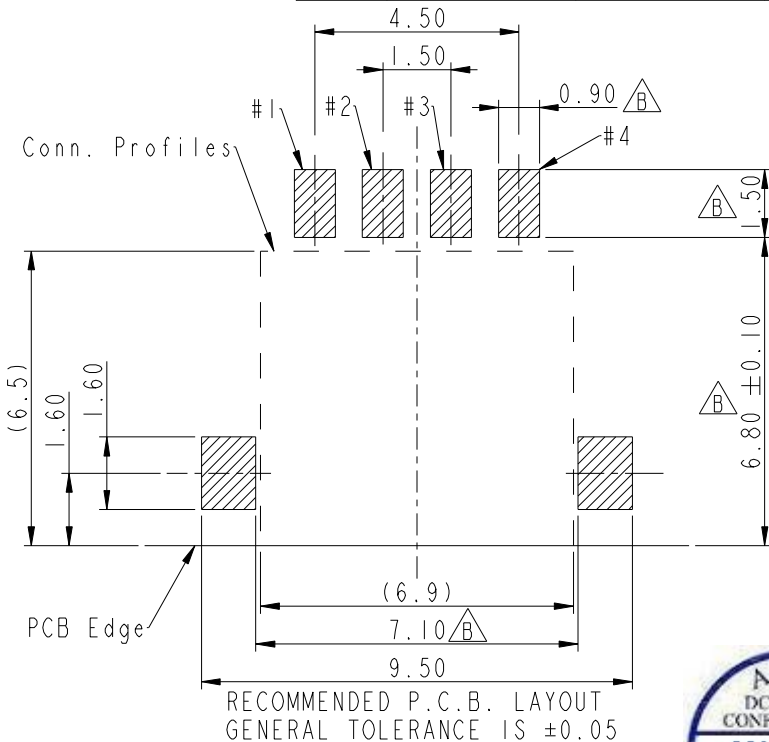
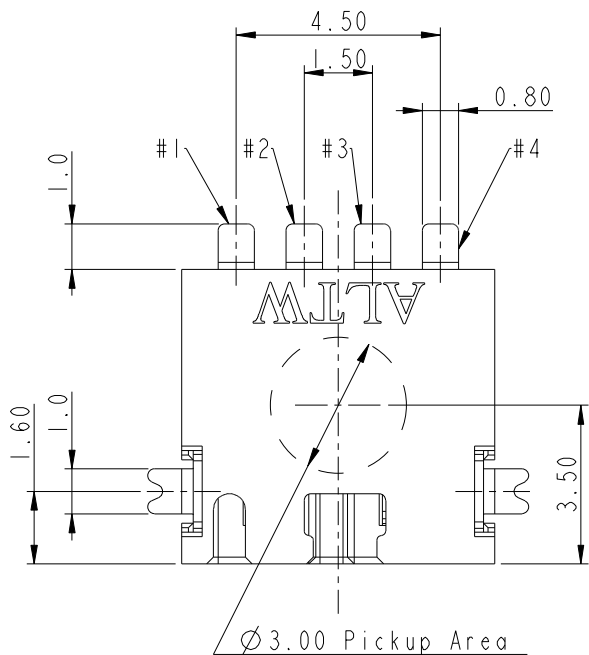

- Notes:
- \* Important Dimension To Check.
  - \* Housing: High temperature thermoplastic. UL94V-0, color is Natural white.
  - \* Terminal: Copper Alloy, Gold Plated on contact area. Tin plated on solder tails.
  - \* Solder Peg: Copper Alloy, Tin plated over Nickel.

UNIT: mm

TOLERANCE	
.X	±0.25
.XX	±0.1
.XXX	±0.05
ANGLES	±1°

TITLE SSL-1.1 DC JACK CONNECTOR 4-POS. W/O POST, SMT TYPE			
SCALE	6:1	SIZE	A4
SHEET	1	OF	2
REV.	C	WC-REV.	C.2
QC: Inspection item			

**Amphenol LTW**  
安費諾亮泰企業股份有限公司

ITEM NO	SSL11-J4D00-000001	DRAWN BY	Fisher_Wang	DATE	2013-12-16
DWG NO	SSL11-J4D00-000001	CHECKED BY	Ivan_Lin	DATE	2013-12-16
CUSTOMER	ALTW	APPROVED BY	Kevin_Hu	DATE	2013-12-16

THIS DOCUMENT IS SUBJECT TO CHANGE WITHOUT NOTICE. IT IS CONFIDENTIAL AND A PROPERTY OF Amphenol LTW. DISCLOSURE TO THIRD PARTY HAS TO BE AUTHORIZED BY Amphenol LTW.

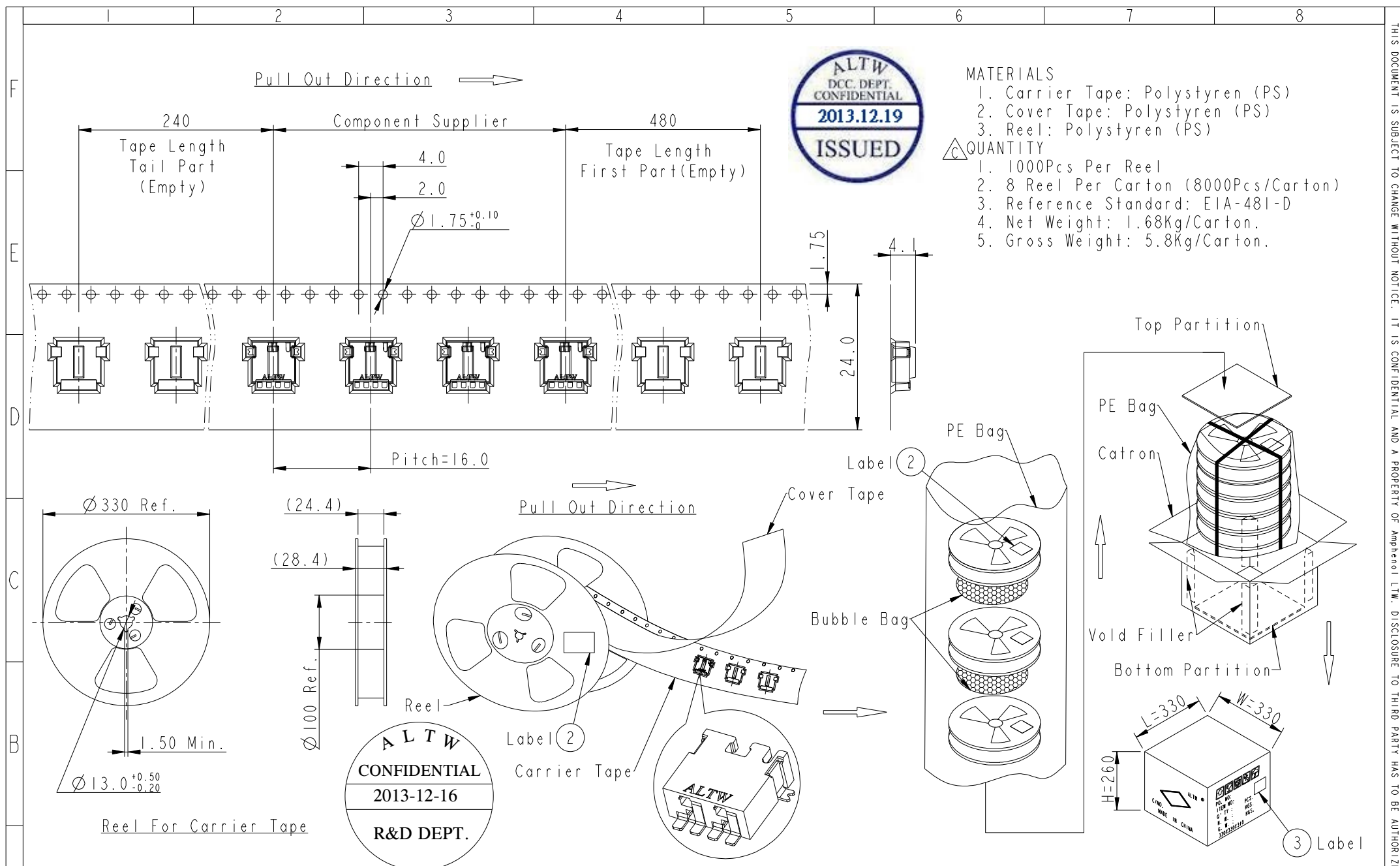

- MATERIALS**
1. Carrier Tape: Polystyren (PS)
  2. Cover Tape: Polystyren (PS)
  3. Reel: Polystyren (PS)
- QUANTITY**
1. 1000Pcs Per Reel
  2. 8 Reel Per Carton (8000Pcs/Carton)
  3. Reference Standard: EIA-481-D
  4. Net Weight: 1.68Kg/Carton.
  5. Gross Weight: 5.8Kg/Carton.

**UNIT:mm**

TOLERANCE	
.X	±0.25
.XX	±0.1
.XXX	±0.05
ANGLES	±1°

TITLE SSL-1.1 DC JACK CONNECTOR 4-POS. W/O POST, SMT TYPE			
SCALE	5:1	SIZE	A4
REV.	C	WC-REV.	C.2
		SHEET	2 OF 2
◎: Inspection item			

**Amphenol LTW**  
安費諾亮泰企業股份有限公司

ITEM NO	SSL11-J4D00-000001	DRAWN BY	Fisher_Wang	DATE	2013-12-16
DWG NO	SSL11-J4D00-000001	CHECKED BY	Ivan_Lin	DATE	2013-12-16
CUSTOMER	ALTW	APPROVED BY	Kevin_Hu	DATE	2013-12-16