



Main

Range of product	Harmony Relay
Product or component type	Solid state relay
Device short name	SSD1
Number of channels	1
Number of phases	1 phase
Product configuration type	Relay configuration
Mounting support	35 mm symmetrical DIN rail EN/IEC 60715
Rated current	30 A
Contact type	1 NO

Complementary

Rated duty	Uninterrupted
Output voltage	1...150 V DC
Control circuit voltage	4...32 V DC
Tightening torque	1.5...1.7 N.m control input 13...15 lb.in control input 1.5...1.7 N.m load output 13...15 lb.in load output
Connections - terminals	Input screw terminals Output screw terminals
Dielectric strength	3.75 kV AC input/output circuit 3.75 kV AC input or output to case
Rated impulse withstand voltage	6 kV input/output circuit 6 kV input or output to case
Insulation resistance	1000 MOhm 500 V DC
Local signalling	Control voltage LED green)
Pick-up voltage	4 V DC turn-on
Drop-out voltage	1 V DC turn-off
Input current range	11...15 mA
Solid state output type	Mosfet output
Solid state switching type	DC switching
Load current	0.005...30 A
Inrush current	86 A 10 ms
Maximum voltage drop	<0.535 V on-state
Motor controller rating	0.37 kW 0.5 hp 120 V DC

Electromagnetic compatibility	Electrostatic discharge 4 kV criteria A contact discharge IEC 61000-4-2 Electrostatic discharge 4 kV criteria A air discharge IEC 61000-4-2 Conducted RF disturbances 10 V, 0.15...80 MHz criteria A level 3 IEC 61000-4-6 Electrical fast transient/burst immunity test 2 kV, 5/100 kHz criteria A output ports IEC 61000-4-4 Electrical fast transient/burst immunity test 1 kV, 5/100 kHz criteria A input ports IEC 61000-4-4 Radiated radio-frequency electromagnetic field immunity test 10 V/m, 80 MHz...1 GHz criteria A IEC 61000-4-3 Radiated radio-frequency electromagnetic field immunity test 3 V/m, 1.4...2 GHz criteria A IEC 61000-4-3 Radiated radio-frequency electromagnetic field immunity test 1 V/m, 2...2.7 GHz criteria A IEC 61000-4-3 Surge immunity test 1 kV criteria B output ports line to line IEC 61000-4-5 Surge immunity test 2 kV criteria B output ports line to earth IEC 61000-4-5 Radiated emission environment B for DC input supply IEC 60947-4-3 Conducted emission environment B for DC input supply IEC 60947-4-3
Device form designation	Form 5
Resistance	0.016 Ohm on-state
Maximum leakage current	0.2 mA off-state
Response time	75 µs turn-on) 100 µs turn-off)
Short circuit protection coordination	Type 1 Type 2
Overvoltage category	III
Width	0.89 in (22.5 mm)
Height	3.67 in (93.2 mm)
Depth	4.59 in (116.5 mm)
Net weight	0.66 lb(US) (0.298 kg)
Device presentation	Complete product

Environment

Flammability rating	V-0 UL 94
Vibration resistance	0.75 mm 10...150 Hz) EN/IEC 60068-2-6
Shock resistance	Peak acceleration EN/IEC 60068-2-27 Peak acceleration EN/IEC 60068-2-27
Pollution degree	2
Standards	IEC 61373:class B category 1 CSA C22.2 No 14-13 UL 508
IP degree of protection	IP20
Ambient air temperature for operation	-40...176 °F (-40...80 °C)
Ambient air temperature for storage	-40...212 °F (-40...100 °C)

Ordering and shipping details

Category	22375 - INTERFACE MODULE(ABA,R,S)
Discount Schedule	CP2
Nbr. of units in pkg.	1
Package weight(Lbs)	1 lb(US) (0.45 kg)
Returnability	No

Packing Units

Unit Type of Package 1	PCE
Package 1 Height	0.89 in (2.25 cm)
Package 1 width	3.67 in (9.32 cm)
Package 1 Length	4.59 in (11.65 cm)

Offer Sustainability

Sustainable offer status	Green Premium product
California proposition 65	WARNING: This product can expose you to chemicals including: Lead and lead compounds, which is known to the State of California to cause cancer and birth defects or other reproductive harm. For more information go to www.P65Warnings.ca.gov
REACH Regulation	REACH Declaration
REACH free of SVHC	Yes
EU RoHS Directive	Pro-active compliance (Product out of EU RoHS legal scope) EU RoHS Declaration
Mercury free	Yes
RoHS exemption information	Yes
China RoHS Regulation	China RoHS Declaration
Environmental Disclosure	Product Environmental Profile
Circularity Profile	End Of Life Information
WEEE	The product must be disposed on European Union markets following specific waste collection and never end up in rubbish bins.

Dimensions

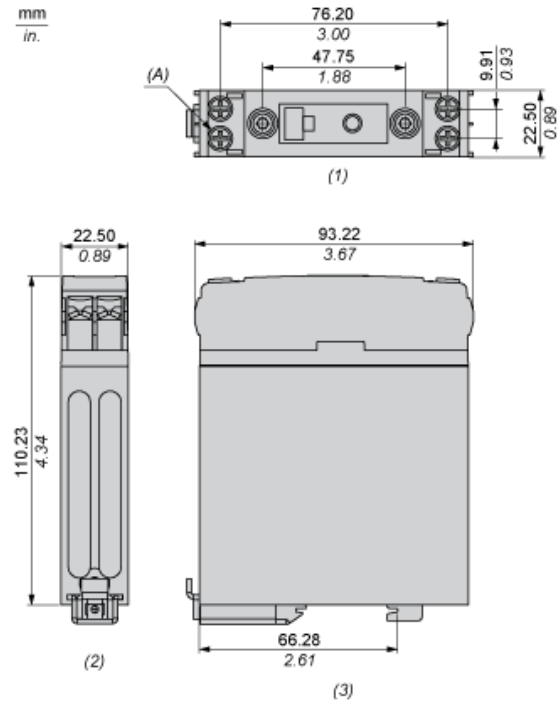

- (1) Front view
- (2) Top view
- (3) Side view
- (A) Screw M4 Stud (4 Places)

Derating Curves

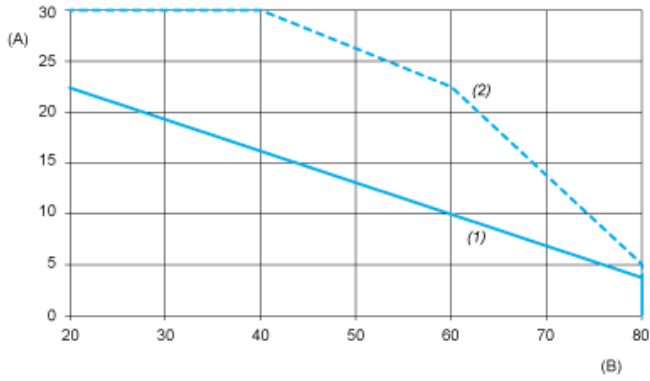

- A : Load Current (Amperes)
- B : Ambient Temperature (°C)
- 1 : Multiple units, no minimum spacing between components
- 2 : Installed single unit, distance to adjacent components more than 22.5 mm