

SS1V-03550-CH

Aliases (UAL11V03550CH0, SS1V/H-03550-CH)

Not for New Design

KEMET, SS1V/H-CH, AC Line Filters, Common Mode, 55 mH

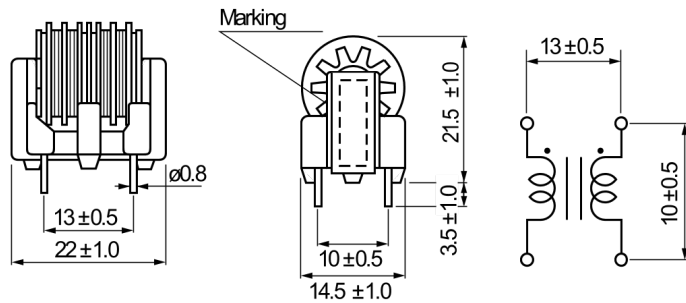

General Information

Series	SS1V/H-CH
Style	Through-Hole
RoHS	Yes
Miscellaneous	Inductance Measurement Condition: 1kHz 1V KC530.

Specifications

Voltage AC	250 VAC
Inductance	55 mH
Current	300 mA
Temperature Range	-25/+120°C
DC Resistance	4.1 Ohms

Dimensions

L	22mm +/-1mm
T	14.5mm +/-1mm
H	21.5mm +/-1mm
LL	3.5mm +/-1mm
S	13mm +/-0.5mm
S1	10mm +/-0.5mm

Packaging Specifications

Typical Component Weight	10.5 g
--------------------------	--------

Statements of suitability for certain applications are based on our knowledge of typical operating conditions for such applications, but are not intended to constitute - and we specifically disclaim - any warranty concerning suitability for a specific customer application or use. This information is intended for use only by customers who have the requisite experience and capability to determine the correct products for their application. Any technical advice inferred from this information or otherwise provided by us with reference to the use of our products is given gratis, and we assume no obligation or liability for the advice given or results obtained.