



CGS SP

TE Internal #: E87503-000

Width 50.8 mm [2 in], Height 95.3 mm [3.75 in], Compatible Cable Diameter Range 8.1 – 22.2 mm [.318 – .875 in], Polyester, CGS SP, Standard Labels

[View on TE.com >](#)

Identification & Labeling > Labels > Standard Labels > SP Self Laminating Polyester Labels



Label Type: **Self-Laminating**

Label Style: **Die-Cut**

Label Adhesive Type: **Permanent Acrylic Adhesive**

Product Width: **50.8 mm [2 in]**

Length of Label Roll: **127 m [416.66 ft]**

[All SP Self Laminating Polyester Labels \(10\)](#)

Features

Product Type Features

Printable Label Height	25.4 mm[1 in]
Label Type	Self-Laminating

Body Features

Primary Product Material	Polyester
--------------------------	-----------

Dimensions

Product Width	50.8 mm[2 in]
Product Height	95.3 mm[3.75 in]
Compatible Cable Diameter Range	8.1 – 22.2 mm[.318 – .875 in]

Usage Conditions

Operating Temperature Range	-40 – 150 °C[-40 – 302 °F]
-----------------------------	----------------------------

Printer/Label Features

Number of Labels Across	2
Label Style	Die-Cut
Length of Label Roll	127 m[416.66 ft]
Label Thickness	45 Micron



Packaging Features

Packaging Quantity	2500
Packaging Method	Roll

Other

Label Adhesive Type	Permanent Acrylic Adhesive
---------------------	----------------------------

Product Compliance

[For compliance documentation, visit the product page on TE.com>](#)

EU RoHS Directive 2011/65/EU	Compliant
EU ELV Directive 2000/53/EC	Compliant
China RoHS 2 Directive MIIT Order No 32, 2016	No Restricted Materials Above Threshold
EU REACH Regulation (EC) No. 1907/2006	Current ECHA Candidate List: JUNE 2024 (241) Candidate List Declared Against: JAN 2024 (240) Does not contain REACH SVHC
Halogen Content	Low Halogen - Br, Cl, F, I < 900 ppm per homogenous material. Also BFR/CFR/PVC Free
Solder Process Capability	Not applicable for solder process capability

Product Compliance Disclaimer

This information is provided based on reasonable inquiry of our suppliers and represents our current actual knowledge based on the information they provided. This information is subject to change. The part numbers that TE has identified as EU RoHS compliant have a maximum concentration of 0.1% by weight in homogenous materials for lead, hexavalent chromium, mercury, PBB, PBDE, DBP, BBP, DEHP, DIBP, and 0.01% for cadmium, or qualify for an exemption to these limits as defined in the Annexes of Directive 2011/65/EU (RoHS2). Finished electrical and electronic equipment products will be CE marked as required by Directive 2011/65/EU. Components may not be CE marked. Additionally, the part numbers that TE has identified as EU ELV compliant have a maximum concentration of 0.1% by weight in homogenous materials for lead, hexavalent chromium, and mercury, and 0.01% for cadmium, or qualify for an exemption to these limits as defined in the Annexes of Directive 2000/53/EC (ELV). Regarding the REACH Regulation, the information TE provides on SVHC in articles for this part number is based on the latest European Chemicals Agency (ECHA) 'Guidance on requirements for substances in articles' posted at this URL: <https://echa.europa.eu/guidance-documents/guidance-on-reach>

Compatible Parts



Also in the Series | CGS SP

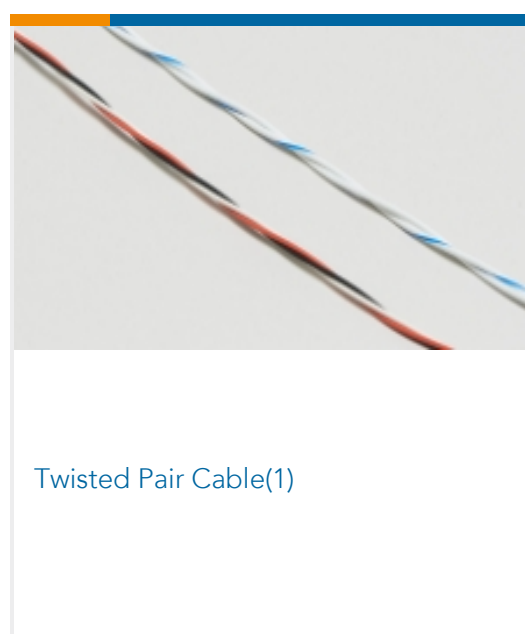
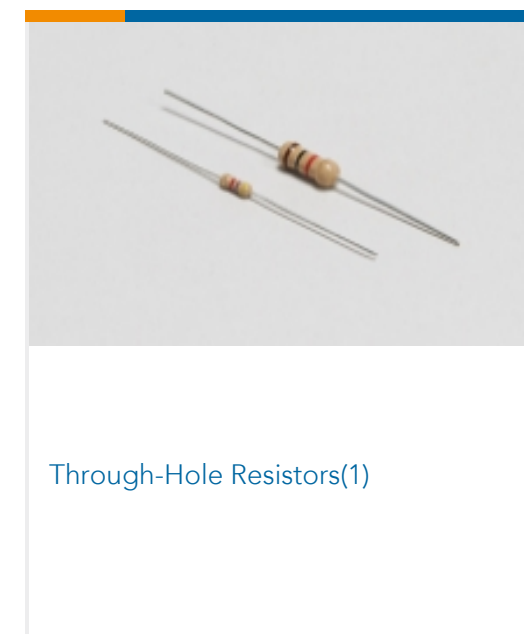
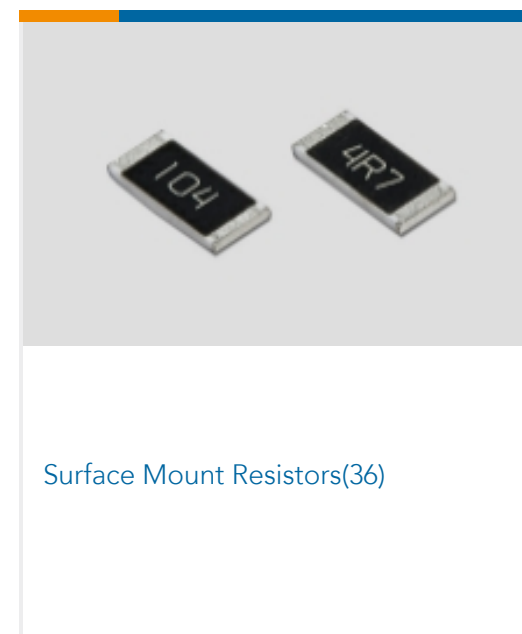
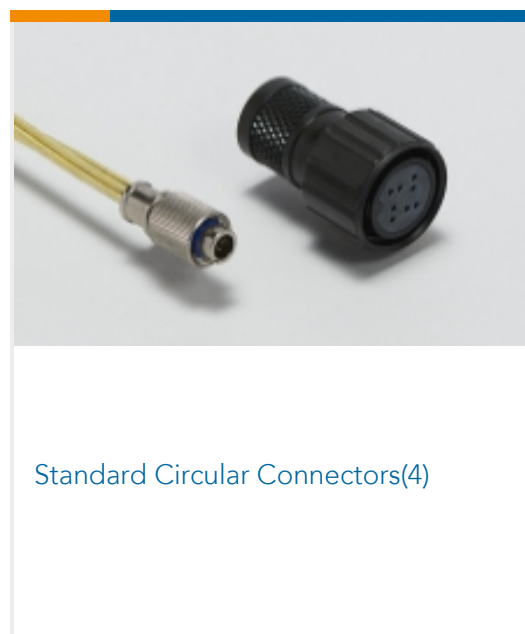
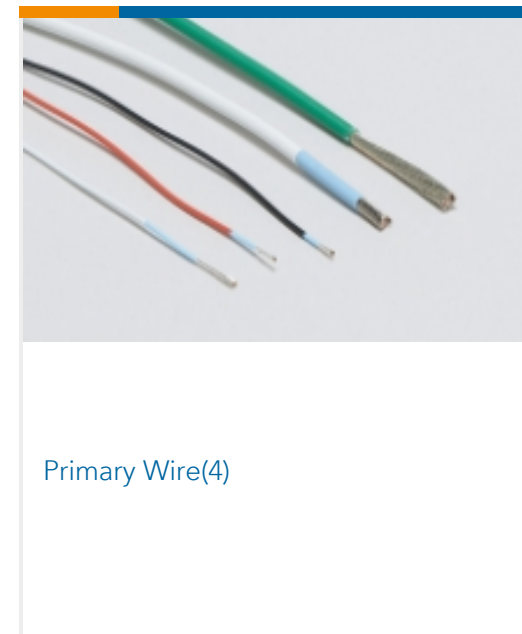
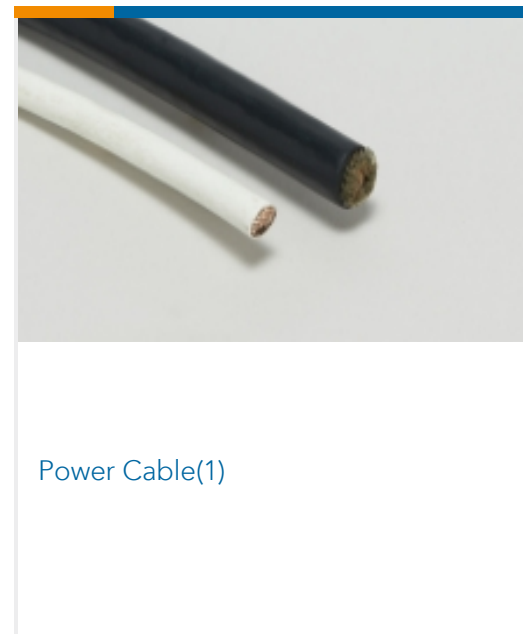
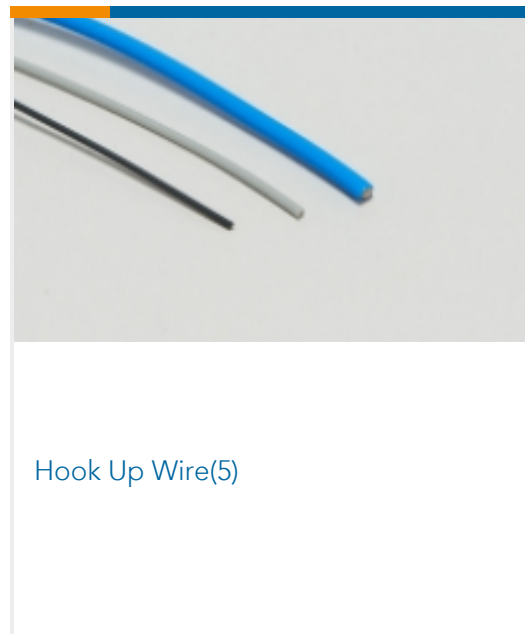

Customers Also Bought

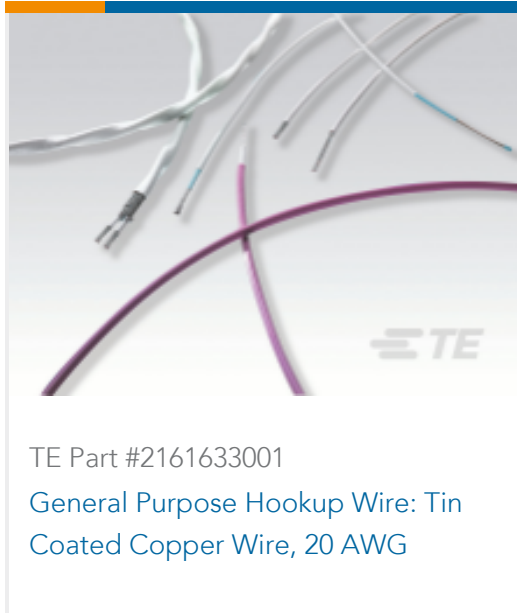
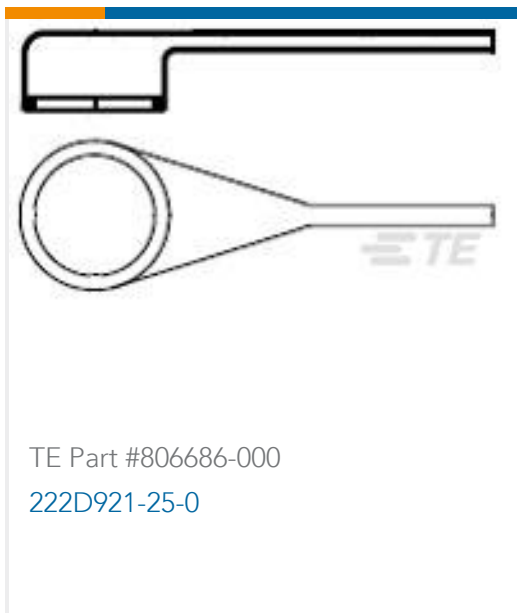

Documents

Product Drawings

[SP200375WE2.5](#)

English

Datasheets & Catalog Pages

[IDENTIFICATION SELECTION GUIDE](#)

English

[Self Laminating Polyester \(SP\) Technical Datasheet](#)

English