

SN5-300

Aliases (UALSN530000000)

KEMET, SN, AC Line Filters, Normal Mode, 0.025 mH, MIN

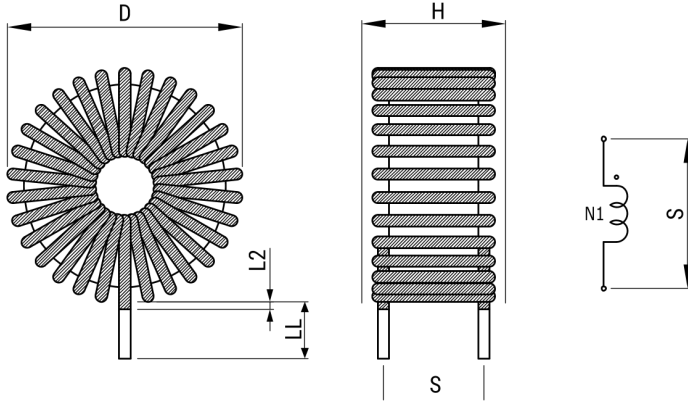

Click [here](#) for the 3D model.

General Information

Series	SN
Style	Through-Hole
Features	Compact Size
RoHS	Yes
Miscellaneous	18 (K) Temperature Rise Max.
Core	Fe

Specifications

Inductance	25 uH (0.1 MHz)
Inductance Tolerance	MIN
Current	2 A
Temperature Range	-40/+105°C
DC Resistance	42 mOhms

Dimensions

D	13mm MAX
H	7mm MAX
LL	20mm +/-2mm
S	6mm
L2	1.5mm MAX
Wire Size	0.55mm

Packaging Specifications

Packaging	Bulk
Packaging Quantity	4800
Typical Component Weight	2.6 g

Statements of suitability for certain applications are based on our knowledge of typical operating conditions for such applications, but are not intended to constitute - and we specifically disclaim - any warranty concerning suitability for a specific customer application or use. This Information is intended for use only by customers who have the requisite experience and capability to determine the correct products for their application. Any technical advice inferred from this Information or otherwise provided by us with reference to the use of our products is given gratis, and we assume no obligation or liability for the advice given or results obtained.