

# SML10Y3-TR

Yellow

Surface Mount LED

3.0 × 3.0 × 1.0mm Chip LED

100° viewing angle

DWG BY:  
BL / GP  
06-12-07

CHK BY:  
PL  
09-11-07

QA:  
\_\_\_\_\_  
\_\_-\_\_-\_\_

MFG:  
\_\_\_\_\_  
\_\_-\_\_-\_\_

REVISION LTR: -  
  
09-11-07

● PACKAGE DIMENSIONS

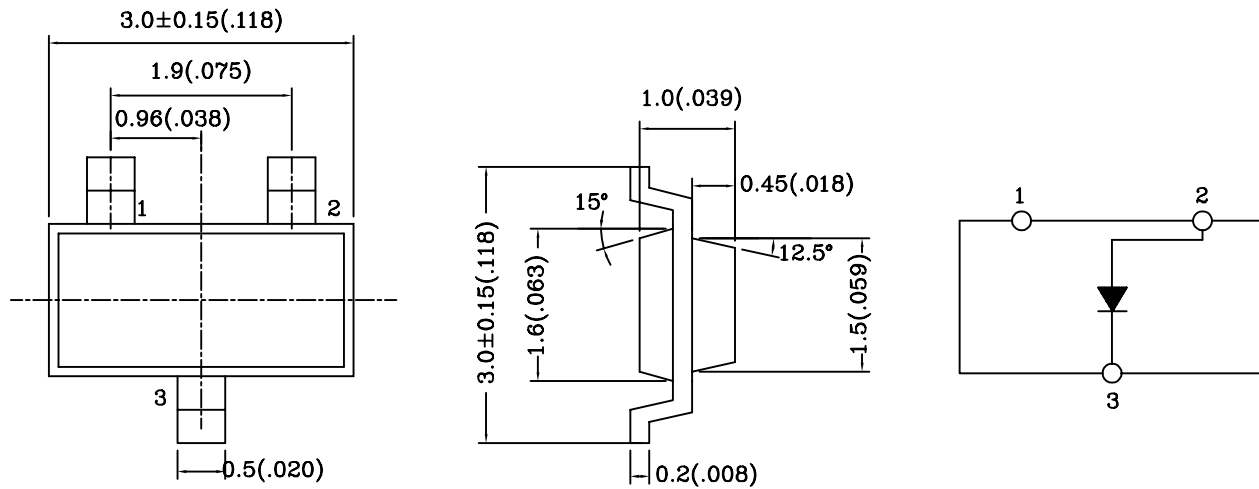

- NOTES: 1.All dimensions are in millimeters (inches).  
 2.Tolerance is  $\pm 0.10$ mm (0.004) unless otherwise specified.  
 3.Specifications are subject to change without notice.  
 4.Condition for IFp is pulse of 1/10 duty and 0.1msec width.

● Absolute Maximum Ratings(Ta=25°C)

Parameter	Symbol	Rating	Unit
Power Dissipation	Pd	100	mW
Forward Current	IF	30	mA
Peak Forward Current * 1	IFP	100	mA
Reverse Voltage	VR	5	V
Operating Temperature	Topr	-25°C~80°C	-
Storage Temperature	Tstg	-30°C~85°C	-
Soldering Temperature	Tsol	See Page6	-

\* 1 Condition for IFP is pulse of 1/10 duty and 0.1msec width.

Remark : Viewing angle is the Off-axis angle at which the luminous intensity is half the axial luminous intensity.

● **Electrical and optical characteristics(Ta=25°C)**

Parameter	Symbol	Condition	Min.	Typ.	Max.	Unit
Forward Voltage	V <sub>F</sub>	I <sub>F</sub> =20mA	-	2.1	2.8	V
Luminous Intensity	I <sub>v</sub>	I <sub>F</sub> =20mA	-	5	-	mcd
Reverse Current	I <sub>R</sub>	V <sub>R</sub> =5V	-	-	100	μA
Peak Wave Length	λ <sub>p</sub>	I <sub>F</sub> =20mA	-	588	-	nm
Dominant Wave Length	λ <sub>d</sub>	I <sub>F</sub> =20mA	-	588	-	nm
Spectral Line Half-width	Δλ	I <sub>F</sub> =20mA	-	36	-	nm
Viewing Angle	2θ <sub>1/2</sub>	I <sub>F</sub> =20mA	-	100	-	deg
Radiant Intensity		I <sub>F</sub> =20mA	-	-	-	μW/sr
Chromaticity Coordinates	X	I <sub>F</sub> =20mA	-	0.56	-	
	Y		-	0.43	-	

● **Typical Electro-Optical Characteristics Curves**

Fig.1 RELATIVE INTENSITY VS. WAVELENGTH

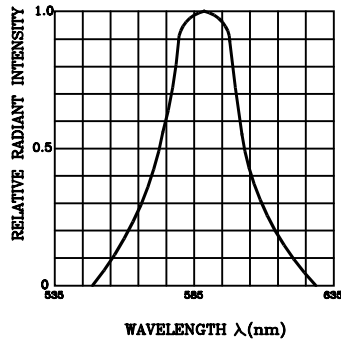

Fig.2 FORWARD CURRENT DERATING CURVE

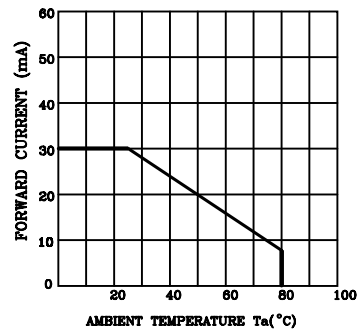

Fig.3 FORWARD CURRENT VS. FORWARD VOLTAGE

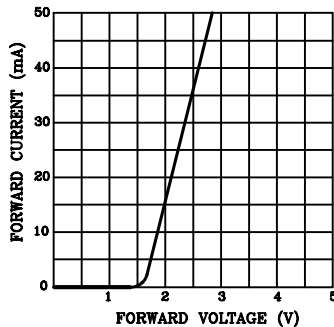

Fig.4 RELATIVE LUMINOUS INTENSITY VS. AMBIENT TEMPERATURE

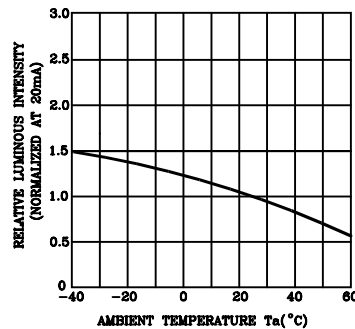

Fig.5 RELATIVE LUMINOUS INTENSITY VS. FORWARD CURRENT

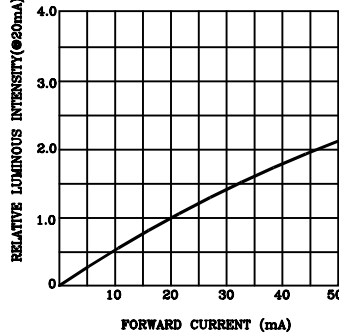
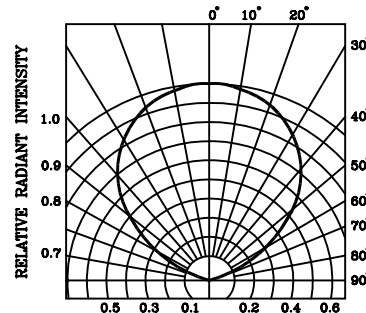
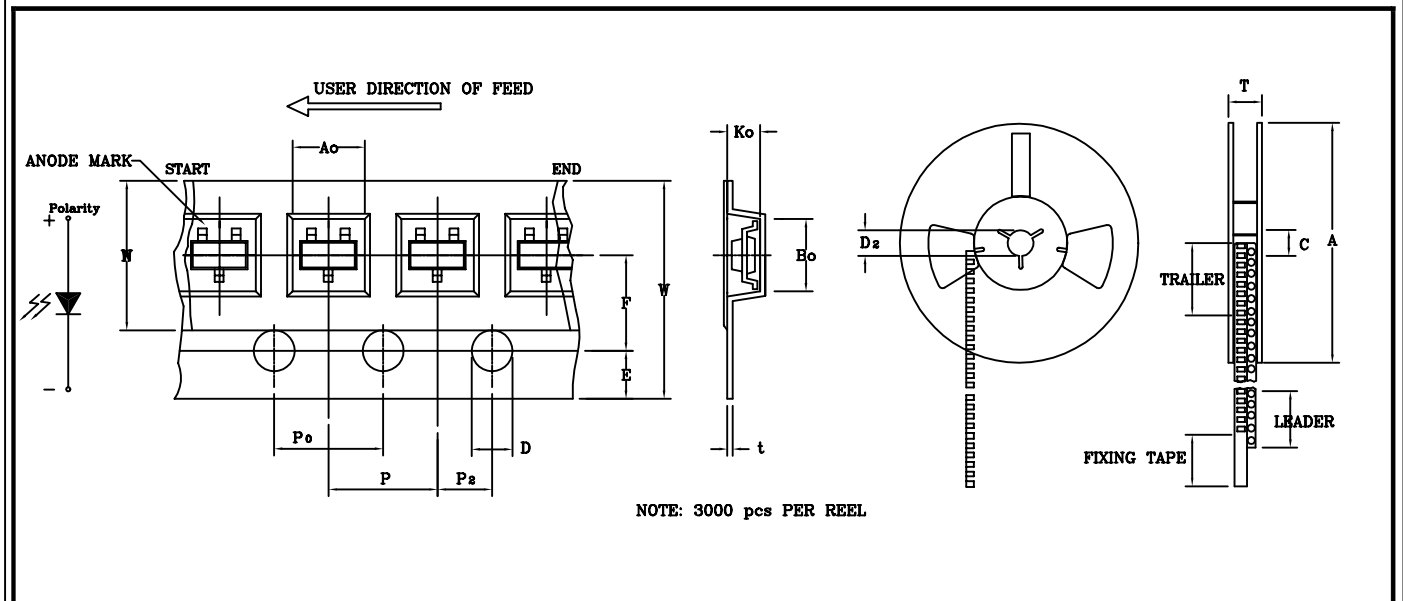

Fig.6 RADIATION DIAGRAM



ITEM	SYMBOL	SPECIFICATION			
		Minimum		Maximum	
		mm	inch	mm	inch
Tape Feed Hole Diameter (DIA)	D	1.50	0.059	1.60	0.063
Feed Hole Location	E	1.65	0.064	1.85	0.073
Centers Line Dimensions Length Direction	F	3.45	0.135	3.55	0.139
Compartment Depth	K <sub>0</sub>	1.40	0.049	1.60	0.057
Compartment Pitch	P	3.90	0.153	4.10	0.161
Sprocket Hole Diameter	P <sub>0</sub>	3.90	0.153	4.10	0.161
Centers Line Dimensions Length Direction	P <sub>2</sub>	1.95	0.076	2.05	0.080
Carrier Tape Thickness	t	—	—	0.30	0.012
Carrier Tape Width	W	7.70	0.303	8.30	0.326
Flange Diameter	A	176.0	6.928	180.0	7.087
Hub Spindle Hole	C	12.50	0.492	13.50	0.531
Hub Diameter	D <sub>2</sub>	20.10	0.791	20.30	0.799
Fixing Tape Width	N	59.00	2.322	61.00	2.402
Flange Space Between Flanges	T	14.30	0.563	14.50	0.571
Compartment Length	A <sub>0</sub>	3.10	0.122	3.30	0.130
Compartment Width	B <sub>0</sub>	3.10	0.122	3.30	0.130



Classification	Test Item	Reference Standard	Test Conditions	Result
Endurance Test	Operation Life	MIL-STD-750:1026 MIL-STD-883:1005 JIS C 7021 :B-1	Connect with a power If=20mA Ta=Under room temperature Test time=1,000hrs	0/20
	High Temperature High Humidity Storage	MIL-STD-202:103B JIS C 7021 :B-11	Ta=+65°C±5°C RH=90%-95% Test time=1,000hrs	0/20
	High Temperature Storage	MIL-STD-883:1008 JIS C 7021 :B-10	High Ta=+85°C±5°C Test time=1,000hrs	0/20
	Low Temperature Storage	JIS-C-7021 :B-12	Low Ta=-35°C±5°C Test time=1,000hrs	0/20
Environmental Test	Temperature Cycling	MIL-STD-202:107D MIL-STD-750:1051 MIL-STD-883:1010 JIS C 7021 :A-4	-35°C ~ +25°C ~ +85°C ~ +25°C 60min 20min 60min 20min Test Time=5cycle	0/20
	Thermal Shock	MIL-STD-202:107D MIL-STD-750:1051 MIL-STD-883:1011	+85°C±5°C ~ -35°C±5°C 20min 20min Test Time=10cycle	0/20
	Solder Resistance	MIL-STD-202:201A MIL-STD-750:2031 JIS C 7021 :A-1	Preheating : 140°C-160°C, within 2 minutes. Operation heating : 235°C (Max.), within 10seconds.(Max.)	0/20

**JUDGMENT CRITERIA OF FAILURE FOR THE RELIABILITY**

Measuring items	Symbol	Measuring conditions	Judgement criteria for failure
Forward voltage	V <sub>F</sub> ( V )	If=20mA	Over U <sub>x</sub> 1.2
Reverse current	I <sub>r</sub> (uA)	V <sub>r</sub> =5V	Over U <sub>x</sub> 2
Luminous intensity	I <sub>v</sub> ( mcd )	If=20mA	Below S <sub>X</sub> 0.5

Note: 1.U means the upper limit of specified characteristics. S means initial value.

2.Measurment shall be taken between 2 hours and after the test pieces have been returned to normal ambient conditions after completion of each test.

**1. SOLDERING :**

● **Manual Of Soldering**

The temperature of the iron tip should not be higher than 300°C (572°F) and Soldering within 3 seconds per solder-land is to be observed.

● **Reflow Soldering**

Preheating : 140°C~160°C ±5°C, within 2 minutes.

Operation heating : 235°C (MAX.) within 10 seconds.(Max)

Gradual Cooling (Avoid quenching).

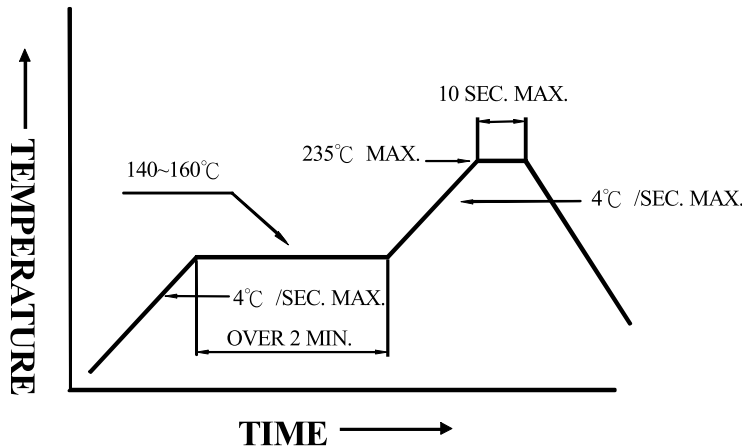

● **DIP soldering (Wave Soldering)**

Preheating : 120°C~150°C, within 120~180 sec.

Operation heating : 245°C ±5°C within 5 sec. 260°C (Max)

Gradual Cooling (Avoid quenching).

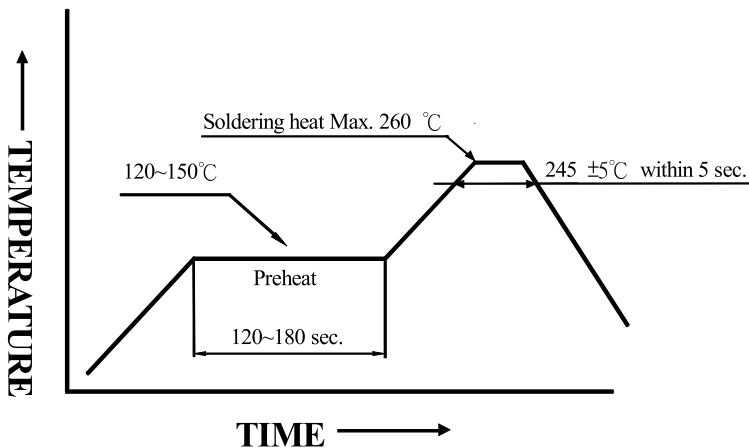

**2. Handling :**

Care must be taken not to cause to the epoxy resin portion of LEDs while it is exposed to high temperature.

Care must be taken not rub the epoxy resin portion of LEDs with hard or sharp article such as the sand blast and the metal hook