

UNCONTROLLED DOCUMENT

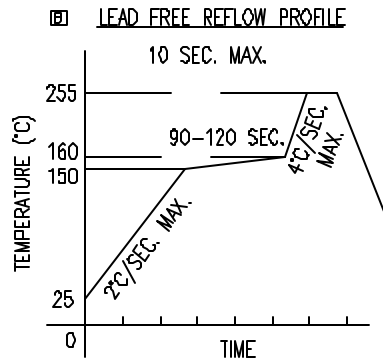

TOTAL TIME ABOVE 220°C IS 60 SECONDS MAX.

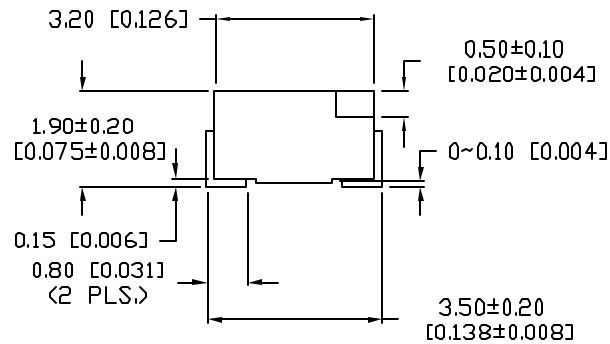
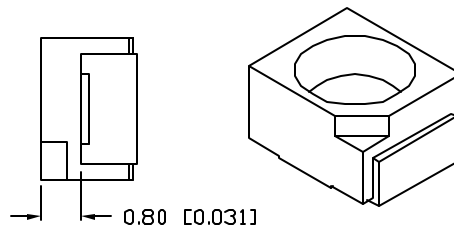
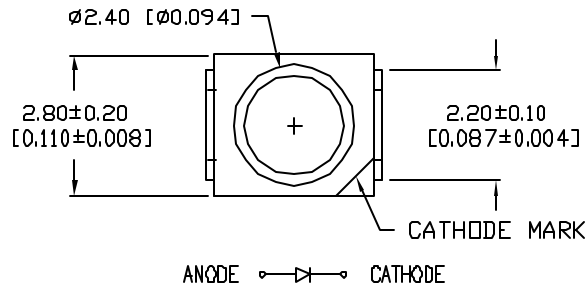
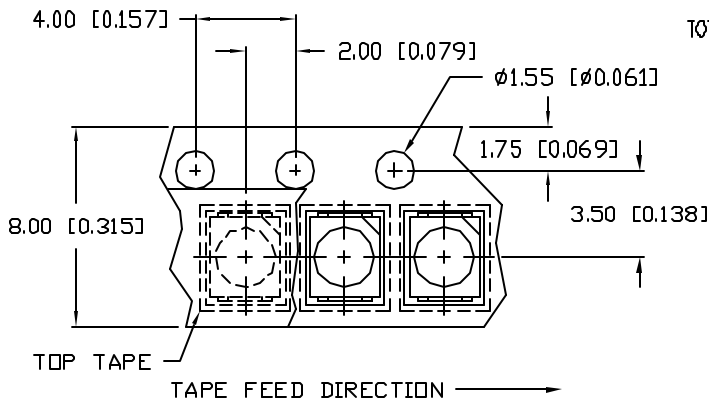

RECOMMENDED SOLDER PAD LAYOUT

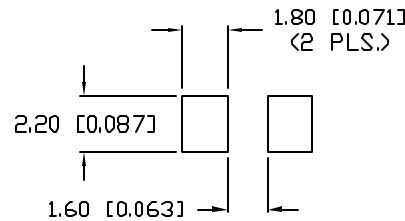

REPLACES PART #: SML-LX2832GC(-TR)

\*UNLESS OTHERWISE SPECIFIED TOLERANCES PER DECIMAL PRECISION ARE: X=±1 (±0.039), XX=±0.5 (±0.020), XXX=±0.25 (±0.010), XXXX=±0.127 (±0.006). LEAD SIZE=±0.05 (±0.002), LEAD LENGTH=±0.75 (±0.030), MIN=+DECIMAL PRECISION MAX.=+0.00 -DECIMAL PRECISION

PART NUMBER  
SML-LX2832GC-TR

REV.  
C

REV.	E.C.N. NUMBER AND REVISION COMMENTS	DATE
A	E.C.N. #10967.	3.14.03
B	E.C.N. #11148.	2.8.05
C	E.C.N. #11402.	03.16.07

ELECTRO-OPTICAL CHARACTERISTICS TA=25°C If=20mA

PARAMETER	MIN	TYP	MAX	UNITS	TEST COND
PEAK WAVELENGTH		565		nm	
FORWARD VOLTAGE		2.1	2.8	Vf	
REVERSE VOLTAGE	5.0			Vr	If=100µA
AXIAL INTENSITY	10	25		mcd	If=20mA
VIEWING ANGLE		120		2x theta	
EMITTED COLOR:	GREEN				
EPOXY LENS FINISH:	WATER CLEAR				

LIMITS OF SAFE OPERATION AT 25°C

PARAMETER	MAX	UNITS
PEAK FORWARD CURRENT*	160	mA
STEADY CURRENT	25	mA
POWER DISSIPATION	100	mW
DERATE FROM 25°C	-1.2	mW/°C
OPERATING TEMP.	-40 TO +85	°C
STORAGE TEMP.	-40 TO +85	°C

\* t<10µs

NOTES:

- THE POLARITY MARK IS ORIENTED TOWARDS THE TAPE SPROCKET HOLE.

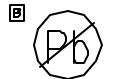

CAUTION: MOISTURE SENSITIVE DEVICE  
PER JEDEC LEVEL 4 STANDARDS

UNCONTROLLED DOCUMENT

REV. C PART NUMBER SML-LX2832GC-TR

2.8mm x 3.2mm SURFACE MOUNT LED WITH REFLECTOR,  
565nm GREEN LED, WATER CLEAR LENS,  
2,000 PIECES PER TAPE AND REEL.

CONFIDENTIAL INFORMATION  
THE INFORMATION CONTAINED IN THIS DOCUMENT IS THE PROPERTY OF LUMEX INC. EXCEPT AS SPECIFICALLY AUTHORIZED IN WRITING BY LUMEX INC, THE HOLDER OF THIS DOCUMENT SHALL KEEP ALL INFORMATION CONTAINED HEREIN CONFIDENTIAL AND SHALL PROTECT SAME IN WHOLE OR IN PART FROM DISCLOSURE AND DISSEMINATION TO ALL THIRD PARTIES.

RELIABILITY NOTE  
OUR MANY YEARS OF EXPERIENCE DATA ACCUMULATION INDICATE THAT SOLDER HEAT IS A MAJOR CAUSE OF EARLY AND FUTURE FAILURE. PLEASE PAY ATTENTION TO YOUR SOLDERING PROCESS.



290 E. HELEN ROAD  
PALATINE, IL 60067-6976  
PHONE: +1.847.359.2790  
US WEB: www.lumex.com  
TW WEB: www.lumex.com.tw

DRAWN BY: JC CHECKED BY: APPROVED BY: DATE: 1.11.01  
PAGE: 1 OF 1  
SCALE: N/A