

# Surface Mount TRANSZORB® Transient Voltage Suppressors

**SMC (DO-214AB)**

 Cathode  Anode

## LINKS TO ADDITIONAL RESOURCES



| PRIMARY CHARACTERISTICS |                 |
|-------------------------|-----------------|
| $V_{BR}$                | 11.1 V to 104 V |
| $V_{WM}$                | 10 V to 85 V    |
| $P_{PPM}$               | 5000 W          |
| $T_J$ max.              | 150 °C          |
| Polarity                | Unidirectional  |
| Package                 | SMC (DO-214AB)  |

## TYPICAL APPLICATIONS

Use in sensitive electronics protection against voltage transients induced by inductive load switching and lighting on ICs, MOSFET, signal lines of sensor units for consumer, computer, industrial, automotive, and telecommunication.

## FEATURES

- Unidirectional
- Peak pulse power:
  - 5000 W (10/1000  $\mu$ s)
  - 40 kW (8/20  $\mu$ s)
- Excellent clamping capability
- Very fast response time
- Low incremental surge resistance
- Meets MSL level 1, per J-STD-020, LF maximum peak of 260 °C
- AEC-Q101 qualified
  - Automotive ordering code: base P/NHM3 for SMC5K10A to SMC5K20A
- Material categorization: for definitions of compliance please see [www.vishay.com/doc?99912](http://www.vishay.com/doc?99912)

**RoHS**  
COMPLIANT  
HALOGEN  
**FREE**

## MECHANICAL DATA

**Case:** SMC (DO-214AB)

Molding compound meets UL 94 V-0 flammability rating  
 Base P/N-M3 - halogen-free, RoHS-compliant  
 Base P/NHM3\_X - halogen-free, RoHS-compliant, and AEC-Q101 qualified  
 (“\_X” denotes revision code e.g. A, B, ... and only available for SMC5K10A to 20A types)

**Terminals:** matte tin plated leads, solderable per J-STD-002 and JESD 22-B102  
 M3 suffix meets JESD 201 class 2 whisker test, HM3 suffix meets JESD 201 class 2 whisker test

### Note

- SMC5K22A to SMC5K85A for industrial grade only

**Polarity:** color band denotes cathode end

| MAXIMUM RATINGS ( $T_A = 25$ °C unless otherwise noted)               |                 |                |      |
|---|-----------------|----------------|------|
| PARAMETER   | SYMBOL          | VALUE          | UNIT |
| Peak pulse power dissipation with a 10/1000 $\mu$ s waveform (fig. 1) | $P_{PPM}^{(1)}$ | 5000           | W    |
| Peak pulse current with a 10/1000 $\mu$ s waveform (fig 3.)           | $I_{PPM}^{(1)}$ | See next table | A    |
| Operating junction and storage temperature range                      | $T_J, T_{STG}$  | -55 to +150    | °C   |

### Note

<sup>(1)</sup> Non-repetitive current pulse, per fig. 3 and derated above  $T_A = 25$  °C, per fig. 2



| <b>ELECTRICAL CHARACTERISTICS</b> ( $T_A = 25\text{ }^\circ\text{C}$ unless otherwise noted) |                     |  |      |                         |                                |  |  |      |   |      |
|--|---------------------|--|------|-------------------------|--------------------------------|--|--|------|---|------|
| DEVICE TYPE  | DEVICE MARKING CODE | BREAKDOWN VOLTAGE $V_{BR}$ AT $I_T$ <sup>(1)</sup> (V) |      | TEST CURRENT $I_T$ (mA) | STAND-OFF VOLTAGE $V_{WM}$ (V) | MAXIMUM REVERSE LEAKAGE AT $V_{WM}$ (μA) | MAXIMUM CLAMPING VOLTAGE $V_C$ AT $I_{PPM}$ 10/1000 μs |      | MAXIMUM CLAMPING VOLTAGE $V_C$ AT $I_{PPM}$ 8/20 μs |      |
|  |                     | MIN.   | MAX. |                         |                                |  | (V)  | (A)  | (V)   | (A)  |
| SMC5K10A   | 5GDY                | 11.1   | 12.3 | 1.0                     | 10                             | 10.0                                     | 17.0   | 294  | 24.1  | 1660 |
| SMC5K12A   | 5GEE                | 13.3   | 14.7 | 1.0                     | 12                             | 5.0                                      | 19.9   | 251  | 25.3  | 1581 |
| SMC5K13A   | 5GEG                | 14.4   | 15.9 | 1.0                     | 13                             | 2.0                                      | 21.5   | 233  | 27.2  | 1471 |
| SMC5K14A   | 5GEK                | 15.6   | 17.2 | 1.0                     | 14                             | 2.0                                      | 23.2   | 216  | 30.0  | 1333 |
| SMC5K15A   | 5GEM                | 16.7   | 18.5 | 1.0                     | 15                             | 2.0                                      | 24.4   | 205  | 32.5  | 1231 |
| SMC5K16A   | 5GEP                | 17.8   | 19.7 | 1.0                     | 16                             | 2.0                                      | 26.0   | 192  | 34.4  | 1163 |
| SMC5K17A   | 5GER                | 18.9   | 20.9 | 1.0                     | 17                             | 2.0                                      | 27.6   | 181  | 37.0  | 1081 |
| SMC5K18A   | 5GET                | 20.0   | 22.1 | 1.0                     | 18                             | 2.0                                      | 29.2   | 171  | 39.3  | 1018 |
| SMC5K20A   | 5GEV                | 22.2   | 24.5 | 1.0                     | 20                             | 2.0                                      | 32.4   | 154  | 42.8  | 935  |
| SMC5K22A   | 5GEX                | 24.4   | 26.9 | 1.0                     | 22                             | 1.0                                      | 35.5   | 141  | 48.2  | 830  |
| SMC5K24A   | 5GEZ                | 26.7   | 29.5 | 1.0                     | 24                             | 1.0                                      | 38.9   | 129  | 51.6  | 775  |
| SMC5K26A   | 5GFE                | 28.9   | 31.9 | 1.0                     | 26                             | 1.0                                      | 42.1   | 119  | 55.8  | 717  |
| SMC5K28A   | 5GFG                | 31.1   | 34.4 | 1.0                     | 28                             | 1.0                                      | 45.4   | 110  | 60.2  | 664  |
| SMC5K30A   | 5GFK                | 33.3   | 36.8 | 1.0                     | 30                             | 1.0                                      | 48.4   | 103  | 64.0  | 625  |
| SMC5K33A   | 5GFM                | 36.7   | 40.6 | 1.0                     | 33                             | 1.0                                      | 53.3   | 93.8 | 69.8  | 573  |
| SMC5K36A   | 5GFP                | 40.0   | 44.2 | 1.0                     | 36                             | 1.0                                      | 58.1   | 86.1 | 76.0  | 526  |
| SMC5K40A   | 5GFR                | 44.4   | 49.1 | 1.0                     | 40                             | 1.0                                      | 64.5   | 77.5 | 84.0  | 476  |
| SMC5K43A   | 5GFT                | 47.8   | 52.8 | 1.0                     | 43                             | 1.0                                      | 69.4   | 72.0 | 90.3  | 443  |
| SMC5K45A   | 5GFV                | 50.0   | 55.3 | 1.0                     | 45                             | 1.0                                      | 72.7   | 68.8 | 94.6  | 423  |
| SMC5K48A   | 5GFX                | 53.3   | 58.9 | 1.0                     | 48                             | 1.0                                      | 77.4   | 64.6 | 100   | 400  |
| SMC5K51A   | 5GFZ                | 56.7   | 62.7 | 1.0                     | 51                             | 1.0                                      | 82.4   | 60.7 | 107   | 374  |
| SMC5K54A   | 5GGE                | 60.0   | 66.3 | 1.0                     | 54                             | 1.0                                      | 87.1   | 57.4 | 113   | 354  |
| SMC5K58A   | 5GGG                | 64.4   | 71.2 | 1.0                     | 58                             | 1.0                                      | 93.6   | 53.4 | 121   | 331  |
| SMC5K60A   | 5GGK                | 66.7   | 73.7 | 1.0                     | 60                             | 1.0                                      | 96.8   | 51.7 | 125   | 320  |
| SMC5K64A   | 5GGM                | 71.1   | 78.6 | 1.0                     | 64                             | 1.0                                      | 103  | 48.5 | 134   | 299  |
| SMC5K70A   | 5GGP                | 77.8   | 86.0 | 1.0                     | 70                             | 1.0                                      | 113  | 44.2 | 146   | 274  |
| SMC5K75A   | 5GGR                | 83.3   | 92.1 | 1.0                     | 75                             | 1.0                                      | 121  | 41.3 | 157   | 255  |
| SMC5K78A   | 5GGT                | 86.7   | 95.8 | 1.0                     | 78                             | 1.0                                      | 126  | 39.7 | 163   | 245  |
| SMC5K85A   | 5GGV                | 94.4   | 104  | 1.0                     | 85                             | 1.0                                      | 137  | 36.5 | 177   | 226  |

**Notes**

- (1) Pulse test:  $t_p \leq 50$  ms
- (2) Surge current waveform per fig. 3 and derated per fig.2
- (3) All terms and symbols are consistent with ANSI/IEEE C62.35

| <b>THERMAL CHARACTERISTICS</b> ( $T_A = 25\text{ }^\circ\text{C}$ unless otherwise noted) |                           |      |                    |
|---|---------------------------|------|--------------------|
| PARAMETER   | SYMBOL                    | TYP. | UNIT               |
| Thermal resistance  | $R_{thJA}$ <sup>(1)</sup> | 90   | $^\circ\text{C/W}$ |
|   | $R_{thJM}$ <sup>(2)</sup> | 4.0  | $^\circ\text{C/W}$ |

**Notes**

- (1) Thermal resistance junction-to-ambient to follow JEDEC<sup>®</sup> 51-2A, device mounted on FR4 PCB, 2 oz. standard footprint
- (2) Thermal resistance junction-to-mount to follow JEDEC<sup>®</sup> 51-14 using Transient Dual Interface Test Method (TDIM)

| <b>IMMUNITY TO STATIC ELECTRICAL DISCHARGE TO THE FOLLOWING STANDARDS</b><br>( $T_A = 25\text{ }^\circ\text{C}$ unless otherwise noted) |                                       |                                  |        |       |
|---|---------------------------------------|----------------------------------|--------|-------|
| STANDARD  | TEST TYPE                             | TEST CONDITIONS                  | SYMBOL | VALUE |
| IEC 61000-4-2   | Human body model (contact mode)       | $C = 150$ pF, $R = 330$ $\Omega$ | ESD    | 30 kV |
|   | Human body model (air discharge mode) |                                  |        | 30 kV |



| ORDERING INFORMATION (Example) |                 |                        |               |                                    |
|--------------------------------|-----------------|------------------------|---------------|------------------------------------|
| PREFERRED P/N                  | UNIT WEIGHT (g) | PREFERRED PACKAGE CODE | BASE QUANTITY | DELIVERY MODE                      |
| SMC5K10A-M3/H <sup>(1)</sup>   | 0.257           | H                      | 850           | 7" diameter plastic tape and reel  |
| SMC5K10A-M3/I <sup>(1)</sup>   | 0.257           | I                      | 3500          | 13" diameter plastic tape and reel |
| SMC5K10AHM3_A/H <sup>(2)</sup> | 0.257           | H                      | 850           | 7" diameter plastic tape and reel  |
| SMC5K10AHM3_A/I <sup>(2)</sup> | 0.257           | I                      | 3500          | 13" diameter plastic tape and reel |

**Notes**

- (1) Available for SMC5K10A to SMC5K85A
- (2) AEC-Q101 qualified, available for SMC5K10A to SMC5K20A only

**RATINGS AND CHARACTERISTICS CURVES** ( $T_A = 25\text{ }^\circ\text{C}$  unless otherwise noted)

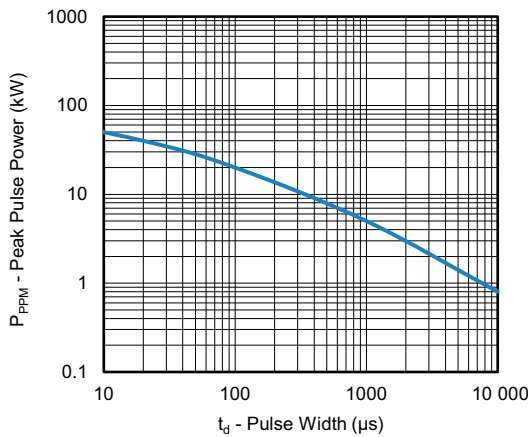

Fig. 1 - Peak Pulse Power Derating Curve

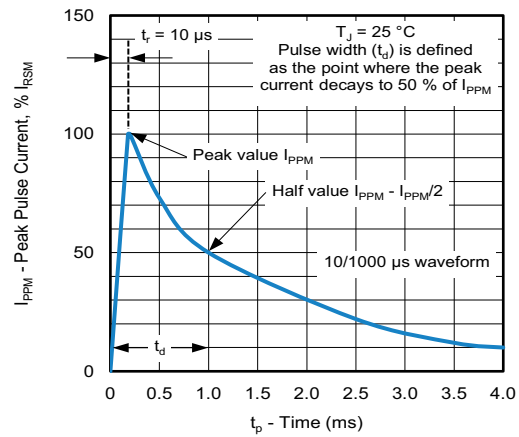

Fig. 3 - Pulse Waveform

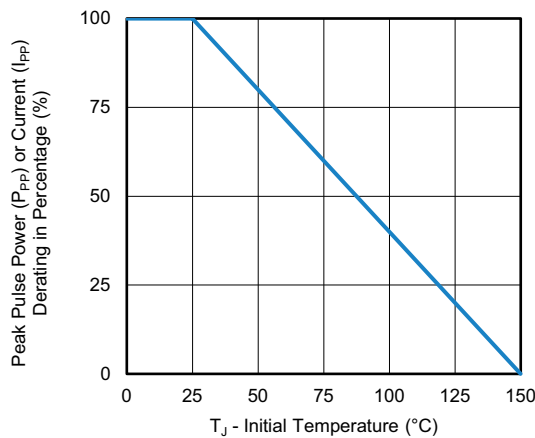

Fig. 2 - Peak Pulse Power or Current vs. Initial Junction Temperature

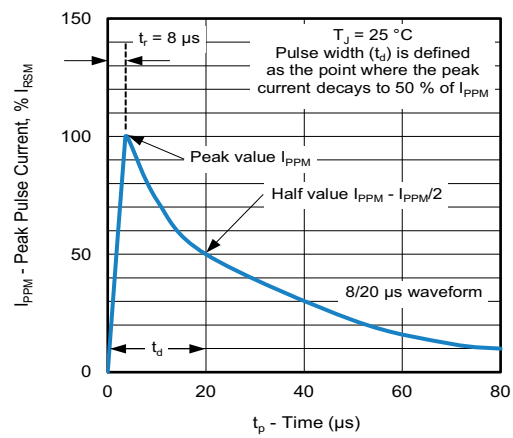

Fig. 4 - Pulse Waveform

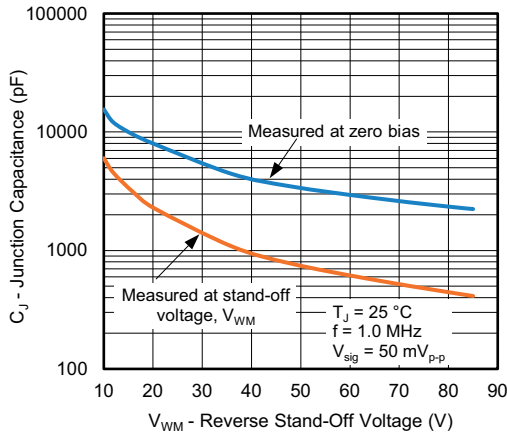

Fig. 5 - Typical Junction Capacitance

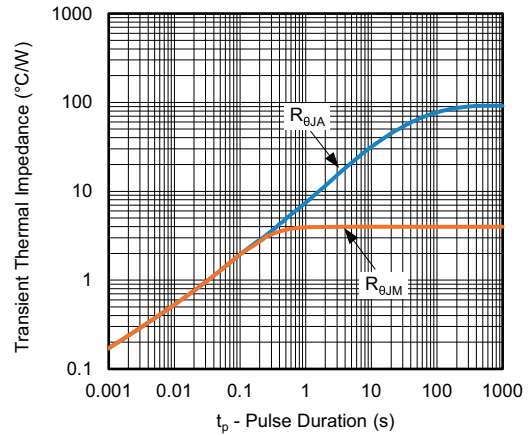
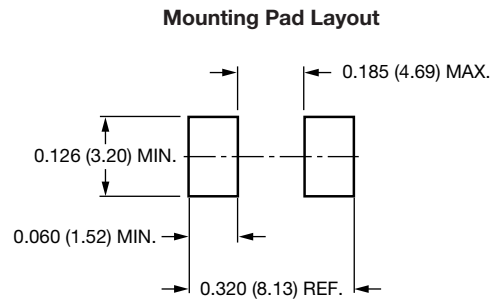
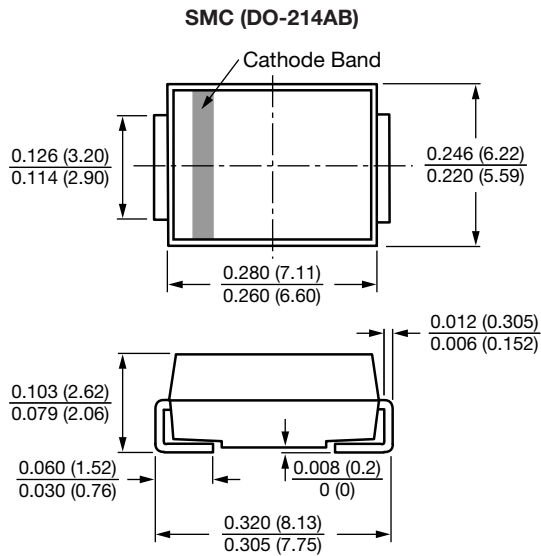

Fig. 6 - Typical Transient thermal Impedance

**Notes**

- Fig.1 - Power calculations is based on  $I_{PPM}$  times defined maximum clamping voltage by pulse width
- Fig.1 - 10 000  $\mu s$   $P_{PPM}$  is actual test for  $V_{WM} \leq 60$  V types, over 60 V types 10 000  $\mu s$   $P_{PPM}$  is curve extensional value

**PACKAGE OUTLINE DIMENSIONS** in inches (millimeters)





## Disclaimer

ALL PRODUCT, PRODUCT SPECIFICATIONS AND DATA ARE SUBJECT TO CHANGE WITHOUT NOTICE TO IMPROVE RELIABILITY, FUNCTION OR DESIGN OR OTHERWISE.

Vishay Intertechnology, Inc., its affiliates, agents, and employees, and all persons acting on its or their behalf (collectively, "Vishay"), disclaim any and all liability for any errors, inaccuracies or incompleteness contained in any datasheet or in any other disclosure relating to any product.

Vishay makes no warranty, representation or guarantee regarding the suitability of the products for any particular purpose or the continuing production of any product. To the maximum extent permitted by applicable law, Vishay disclaims (i) any and all liability arising out of the application or use of any product, (ii) any and all liability, including without limitation special, consequential or incidental damages, and (iii) any and all implied warranties, including warranties of fitness for particular purpose, non-infringement and merchantability.

Statements regarding the suitability of products for certain types of applications are based on Vishay's knowledge of typical requirements that are often placed on Vishay products in generic applications. Such statements are not binding statements about the suitability of products for a particular application. It is the customer's responsibility to validate that a particular product with the properties described in the product specification is suitable for use in a particular application. Parameters provided in datasheets and / or specifications may vary in different applications and performance may vary over time. All operating parameters, including typical parameters, must be validated for each customer application by the customer's technical experts. Product specifications do not expand or otherwise modify Vishay's terms and conditions of purchase, including but not limited to the warranty expressed therein.

Hyperlinks included in this datasheet may direct users to third-party websites. These links are provided as a convenience and for informational purposes only. Inclusion of these hyperlinks does not constitute an endorsement or an approval by Vishay of any of the products, services or opinions of the corporation, organization or individual associated with the third-party website. Vishay disclaims any and all liability and bears no responsibility for the accuracy, legality or content of the third-party website or for that of subsequent links.

Except as expressly indicated in writing, Vishay products are not designed for use in medical, life-saving, or life-sustaining applications or for any other application in which the failure of the Vishay product could result in personal injury or death. Customers using or selling Vishay products not expressly indicated for use in such applications do so at their own risk. Please contact authorized Vishay personnel to obtain written terms and conditions regarding products designed for such applications.

No license, express or implied, by estoppel or otherwise, to any intellectual property rights is granted by this document or by any conduct of Vishay. Product names and markings noted herein may be trademarks of their respective owners.