

SKM 400GB176D

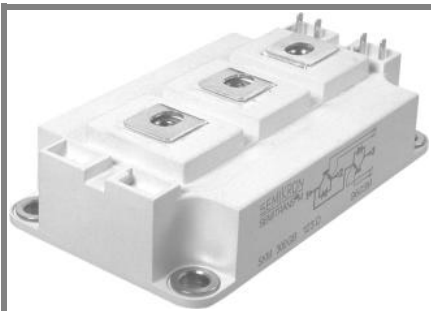

SEMITRANS® 3

Trench IGBT Modules

SKM 400GB176D

SKM 400GAL176D

Features

- Homogeneous Si
- Trench = Trenchgate technology
- $V_{CE(sat)}$ with positive temperature coefficient
- High short circuit capability, self limiting to $6 \times I_C$

Typical Applications*

- AC inverter drives
- mains 575 - 750 V AC
- Public transport (auxiliary syst.)
- Wind power

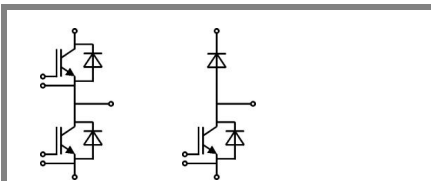

GB

GAL

Absolute Maximum Ratings		$T_{case} = 25^\circ\text{C}$, unless otherwise specified		
Symbol	Conditions	Values		Units
IGBT				
V_{CES}	$T_j = 25^\circ\text{C}$	1700		V
I_C	$T_j = 150^\circ\text{C}$	$T_c = 25^\circ\text{C}$	430	A
		$T_c = 80^\circ\text{C}$	310	A
I_{CRM}	$I_{CRM} = 2 \times I_{Cnom}$	600		A
V_{GES}		± 20		V
t_{psc}	$V_{CC} = 1200\text{ V}; V_{GE} \leq 20\text{ V}; T_j = 125^\circ\text{C}$ $V_{CES} < 1700\text{ V}$	10		μs
Inverse Diode				
I_F	$T_j = 150^\circ\text{C}$	$T_c = 25^\circ\text{C}$	440	A
		$T_c = 80^\circ\text{C}$	300	A
I_{FRM}	$I_{FRM} = 2 \times I_{Fnom}$	600		A
I_{FSM}	$t_p = 10\text{ ms}; \text{sin.}$	$T_j = 150^\circ\text{C}$	2200	A
Freewheeling Diode				
I_F	$T_j = 150^\circ\text{C}$	$T_{case} = 25^\circ\text{C}$	440	A
		$T_{case} = 80^\circ\text{C}$	300	A
I_{FRM}	$I_{FRM} = 2 \times I_{Fnom}$	600		A
I_{FSM}	$t_p = 10\text{ ms}; \text{sin.}$	$T_j = 150^\circ\text{C}$	2200	A
Module				
$I_{t(RMS)}$		500		A
T_{vj}		- 40 ... + 150		$^\circ\text{C}$
T_{stg}		- 40 ... + 125		$^\circ\text{C}$
V_{isol}	AC, 1 min.	4000		V

Characteristics		$T_{case} = 25^\circ\text{C}$, unless otherwise specified			
Symbol	Conditions	min.	typ.	max.	Units
IGBT					
$V_{GE(th)}$	$V_{GE} = V_{CES}, I_C = 12\text{ mA}$	5,2	5,8	6,4	V
I_{CES}	$V_{GE} = 0\text{ V}, V_{CE} = V_{CES}$			4	mA
V_{CE0}		$T_j = 25^\circ\text{C}$	1	1,2	V
		$T_j = 125^\circ\text{C}$	0,9	1,1	V
r_{CE}	$V_{GE} = 15\text{ V}$	$T_j = 25^\circ\text{C}$	3,3	4,2	$\text{m}\Omega$
		$T_j = 125^\circ\text{C}$	5,2	6	$\text{m}\Omega$
$V_{CE(sat)}$	$I_{Cnom} = 300\text{ A}, V_{GE} = 15\text{ V}$				V
		$T_j = 25^\circ\text{C}_{chiplev.}$	2	2,4	V
		$T_j = 125^\circ\text{C}_{chiplev.}$	2,45	2,9	V
C_{ies}	$V_{CE} = 25, V_{GE} = 0\text{ V}$	$f = 1\text{ MHz}$	19,8		nF
C_{oes}			1,1		nF
C_{res}			0,88		nF
Q_G	$V_{GE} = -8\text{V}...+15\text{V}$	2500		nC	
$t_{d(on)}$	$R_{Gon} = 4\ \Omega$	$V_{CC} = 1200\text{V}$ $I_C = 300\text{A}$	330		ns
t_r			55		ns
E_{on}			170		mJ
$t_{d(off)}$	$R_{Goff} = 4\ \Omega$	$T_j = 125^\circ\text{C}$ $V_{GE} = \pm 15\text{V}$	880		ns
t_f			145		ns
E_{off}			118		mJ
$R_{th(j-c)}$	per IGBT	0,075		K/W	

SKM 400GB176D

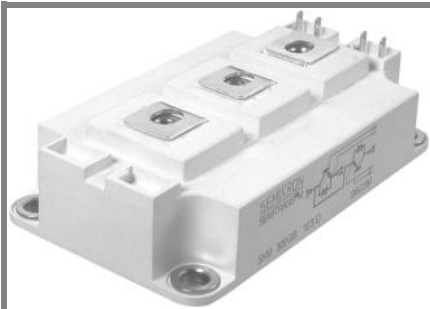

SEMITRANS[®] 3

Trench IGBT Modules

SKM 400GB176D

SKM 400GAL176D

Features

- Homogeneous Si
- Trench = Trenchgate technology
- $V_{CE(sat)}$ with positive temperature coefficient
- High short circuit capability, self limiting to $6 \times I_C$

Typical Applications*

- AC inverter drives
- mains 575 - 750 V AC
- Public transport (auxiliary syst.)
- Wind power

Characteristics					
Symbol	Conditions	min.	typ.	max.	Units
Inverse Diode					
$V_F = V_{EC}$	$I_{Fnom} = 300 \text{ A}; V_{GE} = 0 \text{ V}$	$T_j = 25 \text{ }^\circ\text{C}_{chiplev.}$	1,7	1,9	V
		$T_j = 125 \text{ }^\circ\text{C}_{chiplev.}$	1,8	2	V
V_{F0}		$T_j = 25 \text{ }^\circ\text{C}$	1,2	1,4	V
		$T_j = 125 \text{ }^\circ\text{C}$	0,9	1,1	V
r_F		$T_j = 25 \text{ }^\circ\text{C}$	1,7	1,7	mΩ
		$T_j = 125 \text{ }^\circ\text{C}$	3	3	mΩ
I_{RRM}	$I_F = 300 \text{ A}$	$T_j = 125 \text{ }^\circ\text{C}$	418		A
Q_{rr}	$di/dt = 5800 \text{ A}/\mu\text{s}$		117		μC
E_{rr}	$V_{GE} = -15 \text{ V}; V_{CC} = 1200 \text{ V}$		78		mJ
$R_{th(j-c)D}$	per diode			0,125	K/W
FWD					
$V_F = V_{EC}$	$I_{Fnom} = 300 \text{ A}; V_{GE} = 0 \text{ V}$	$T_j = 25 \text{ }^\circ\text{C}_{chiplev.}$	1,7	1,9	V
		$T_j = 125 \text{ }^\circ\text{C}_{chiplev.}$	1,8	2	V
V_{F0}		$T_j = 25 \text{ }^\circ\text{C}$	1,2	1,4	V
		$T_j = 125 \text{ }^\circ\text{C}$	0,9	1,1	V
r_F		$T_j = 25 \text{ }^\circ\text{C}$	1,7	1,7	V
		$T_j = 125 \text{ }^\circ\text{C}$	3	3	V
I_{RRM}	$I_F = 300 \text{ A}$	$T_j = 125 \text{ }^\circ\text{C}$	418		A
Q_{rr}	$di/dt = 5800 \text{ A}/\mu\text{s}$		117		μC
E_{rr}	$V_{GE} = -15 \text{ V}; V_{CC} = 1200 \text{ V}$		78		mJ
$R_{th(j-c)FD}$	per diode			0,125	K/W
Module					
L_{CE}			15	20	nH
$R_{CC'+EE'}$	res., terminal-chip	$T_{case} = 25 \text{ }^\circ\text{C}$	0,35		mΩ
		$T_{case} = 125 \text{ }^\circ\text{C}$	0,5		mΩ
$R_{th(c-s)}$	per module			0,038	K/W
M_s	to heat sink M6		3	5	Nm
M_t	to terminals M6		2,5	5	Nm
w				325	g

This is an electrostatic discharge sensitive device (ESDS), international standard IEC 60747-1, Chapter IX.

* The specifications of our components may not be considered as an assurance of component characteristics. Components have to be tested for the respective application. Adjustments may be necessary. The use of SEMIKRON products in life support appliances and systems is subject to prior specification and written approval by SEMIKRON. We therefore strongly recommend prior consultation of our personal.

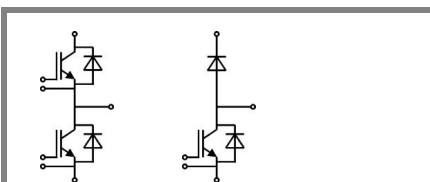

GB

GAL

SKM 400GB176D

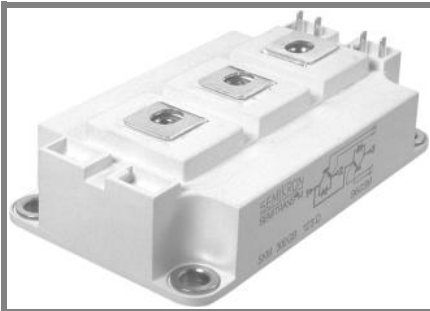

SEMITRANS® 3

Trench IGBT Modules

SKM 400GB176D

SKM 400GAL176D

Features

- Homogeneous Si
- Trench = Trenchgate technology
- $V_{CE(sat)}$ with positive temperature coefficient
- High short circuit capability, self limiting to $6 \times I_C$

Typical Applications*

- AC inverter drives
- mains 575 - 750 V AC
- Public transport (auxiliary syst.)
- Wind power

Z_{th}		Conditions	Values	Units
$Z_{th(j-c)I}$				
$R_{\theta j-c}$		i = 1	52	mk/W
$R_{\theta j-c}$		i = 2	18	mk/W
$R_{\theta j-c}$		i = 3	4,6	mk/W
$R_{\theta j-c}$		i = 4	0,4	mk/W
$\tau_{\theta j-c}$		i = 1	0,0569	s
$\tau_{\theta j-c}$		i = 2	0,0122	s
$\tau_{\theta j-c}$		i = 3	0,002	s
$\tau_{\theta j-c}$		i = 4	0,02	s
$Z_{th(j-c)D}$				
$R_{\theta j-cD}$		i = 1	85	mk/W
$R_{\theta j-cD}$		i = 2	28	mk/W
$R_{\theta j-cD}$		i = 3	10,5	mk/W
$R_{\theta j-cD}$		i = 4	1,5	mk/W
$\tau_{\theta j-cD}$		i = 1	0,054	s
$\tau_{\theta j-cD}$		i = 2	0,0075	s
$\tau_{\theta j-cD}$		i = 3	0,0018	s
$\tau_{\theta j-cD}$		i = 4	0,0002	s

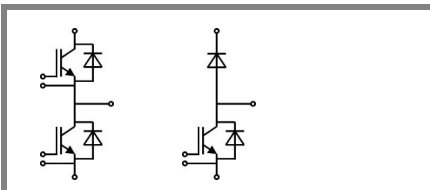

GB

GAL

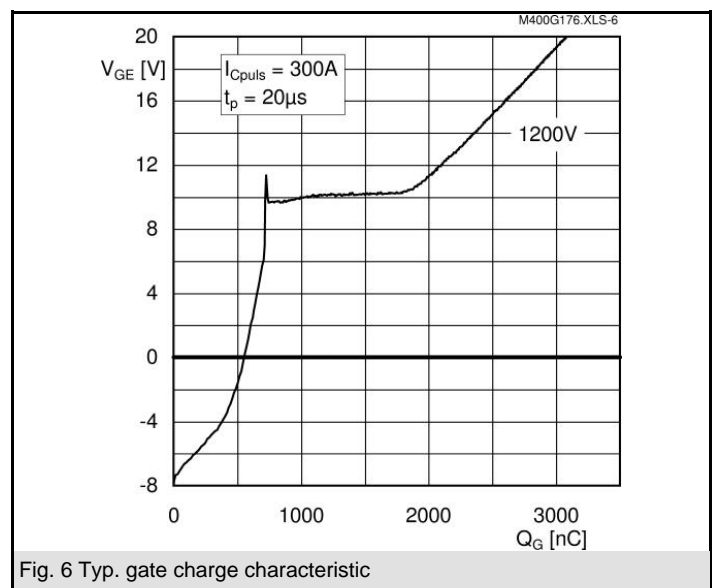
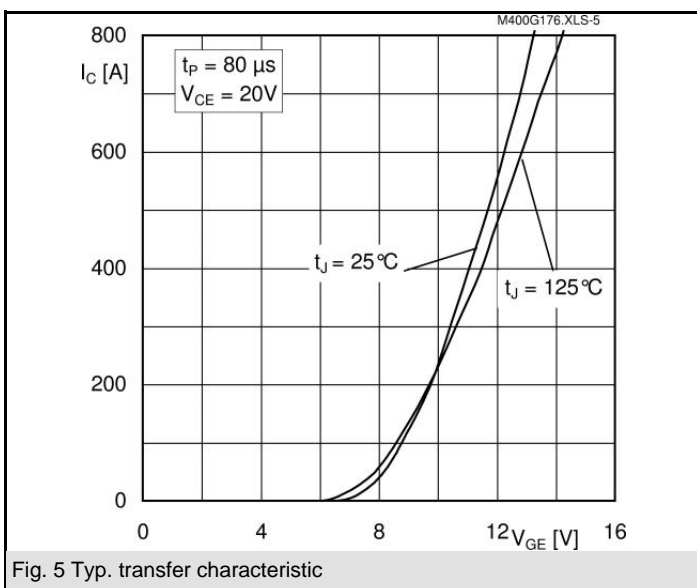
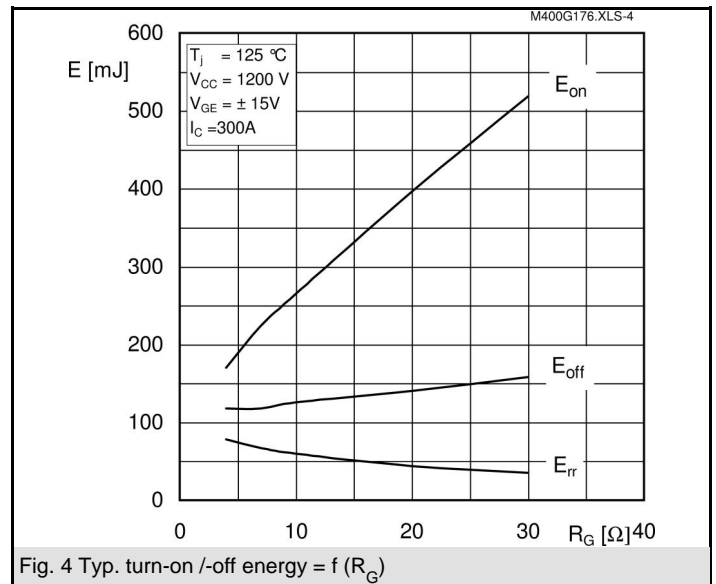
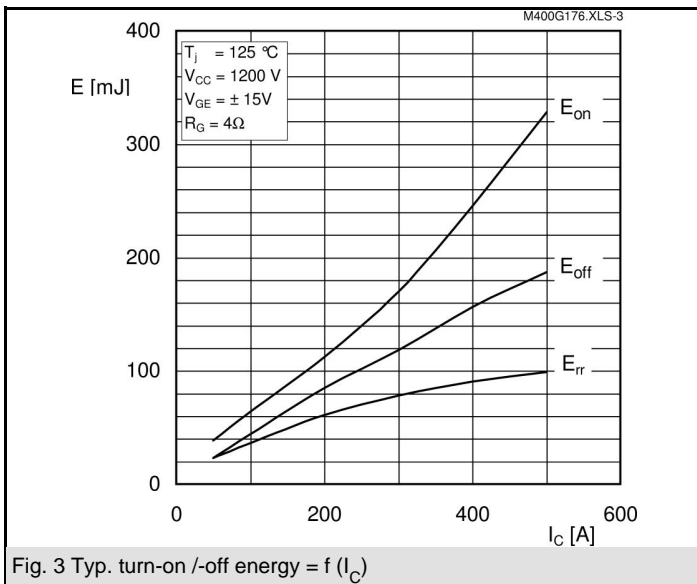
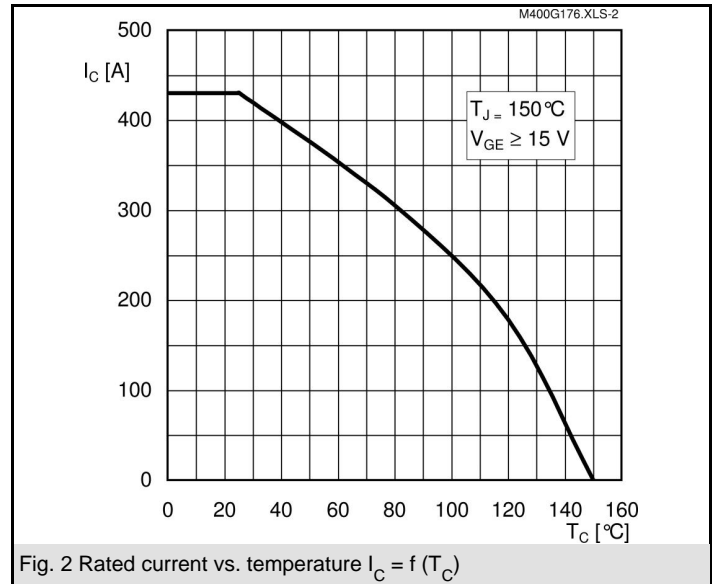
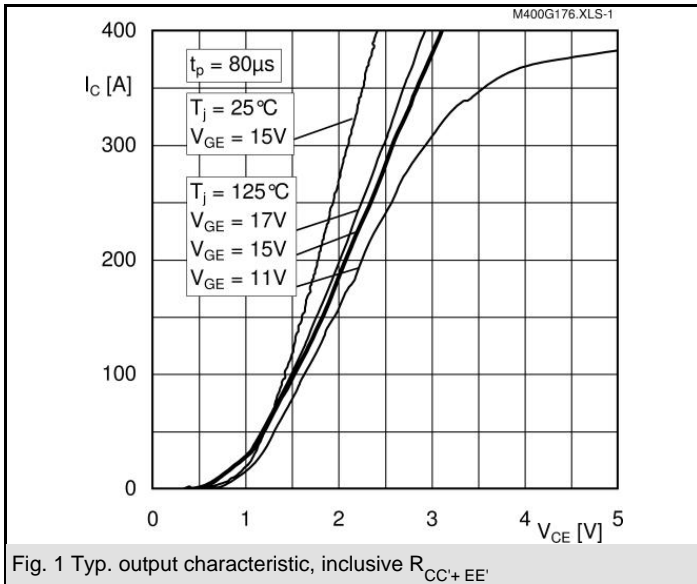

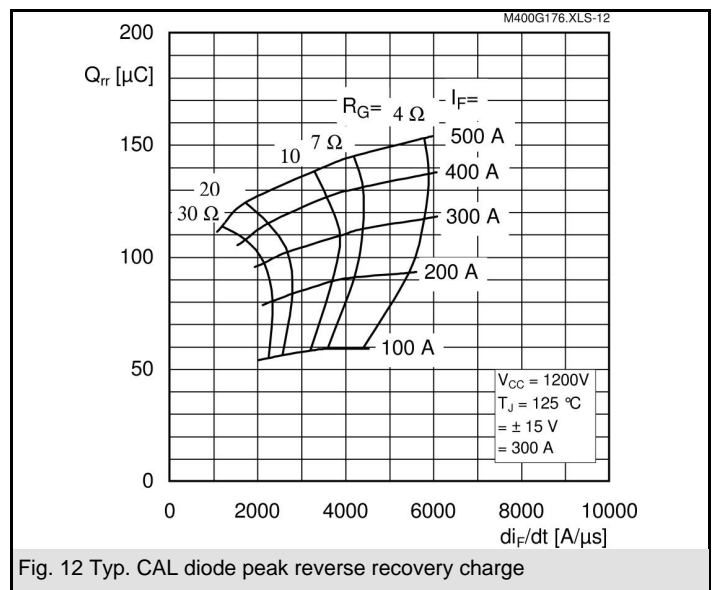
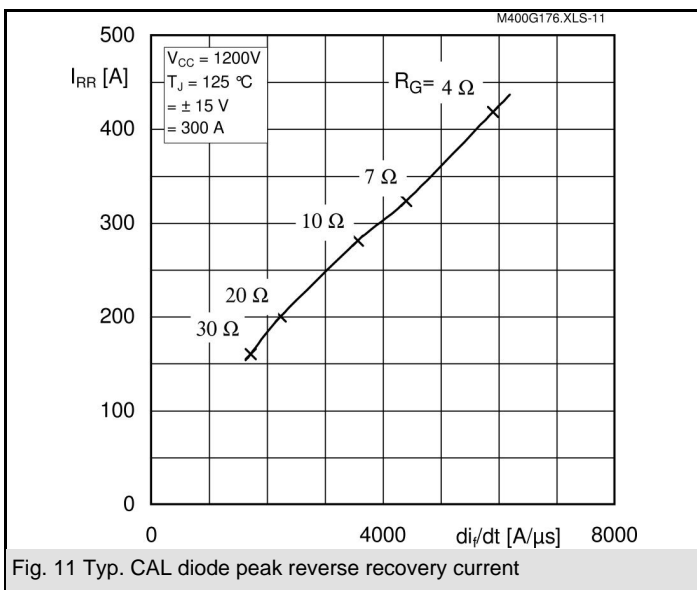
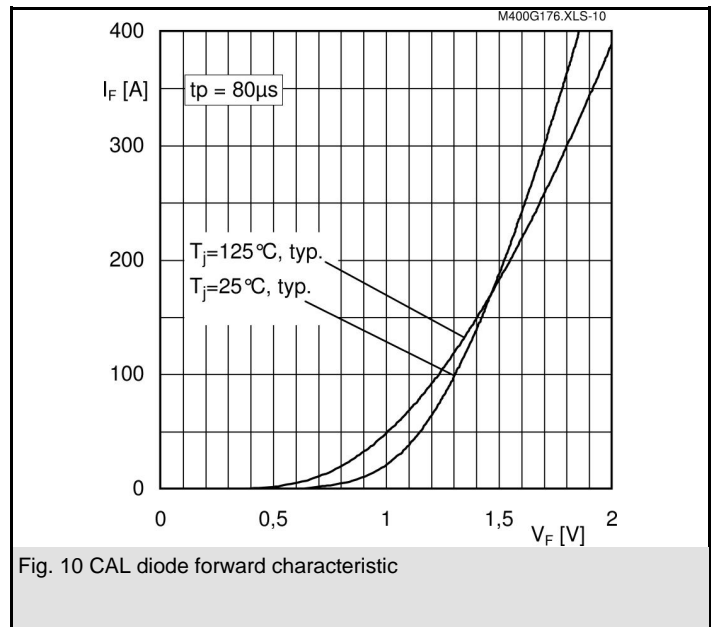
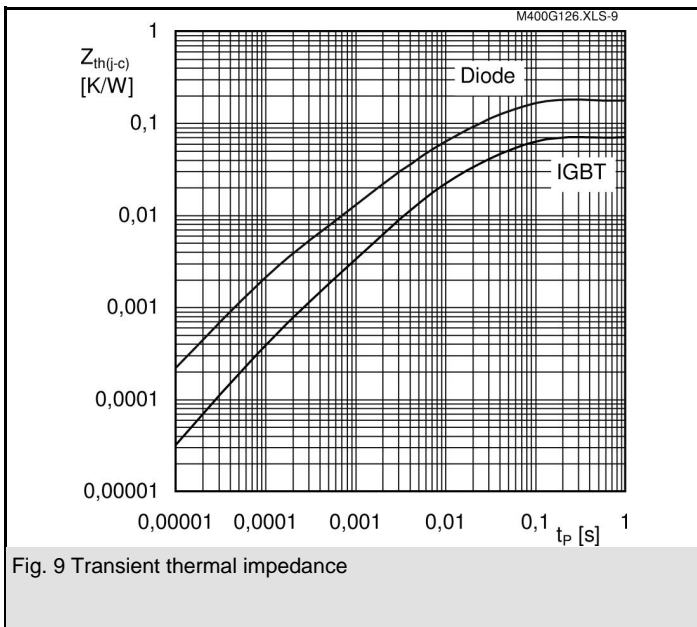
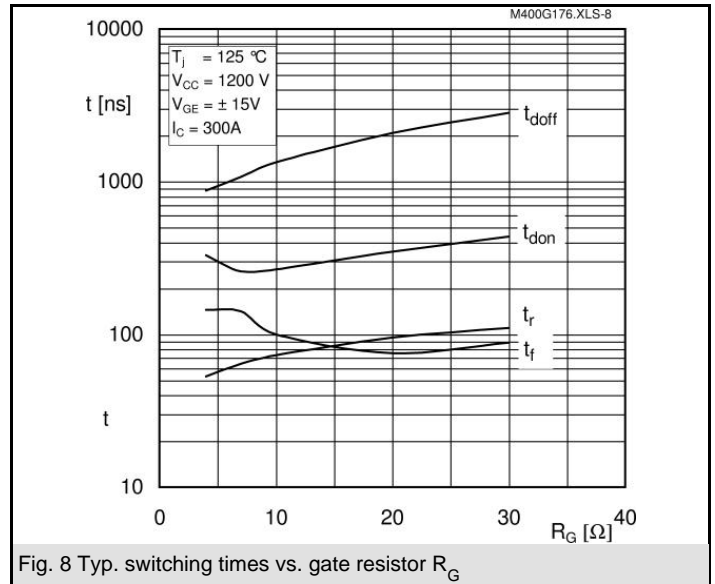
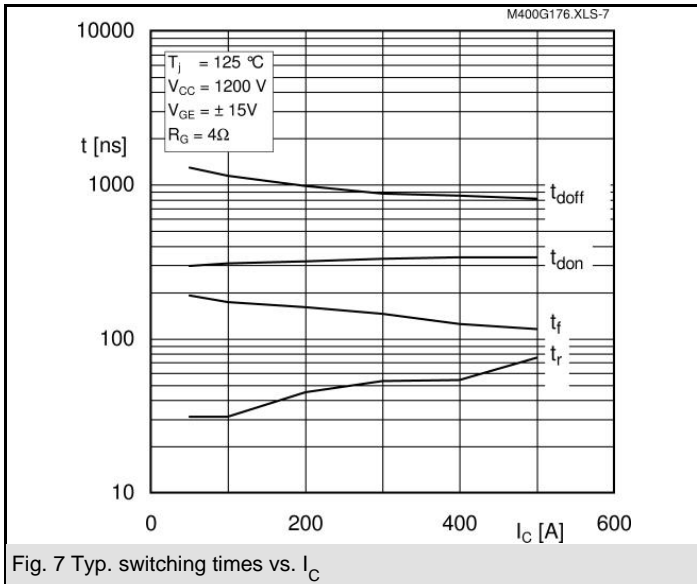

SKM 400GB176D

UL Recognized

CASED56

File no. 63 532

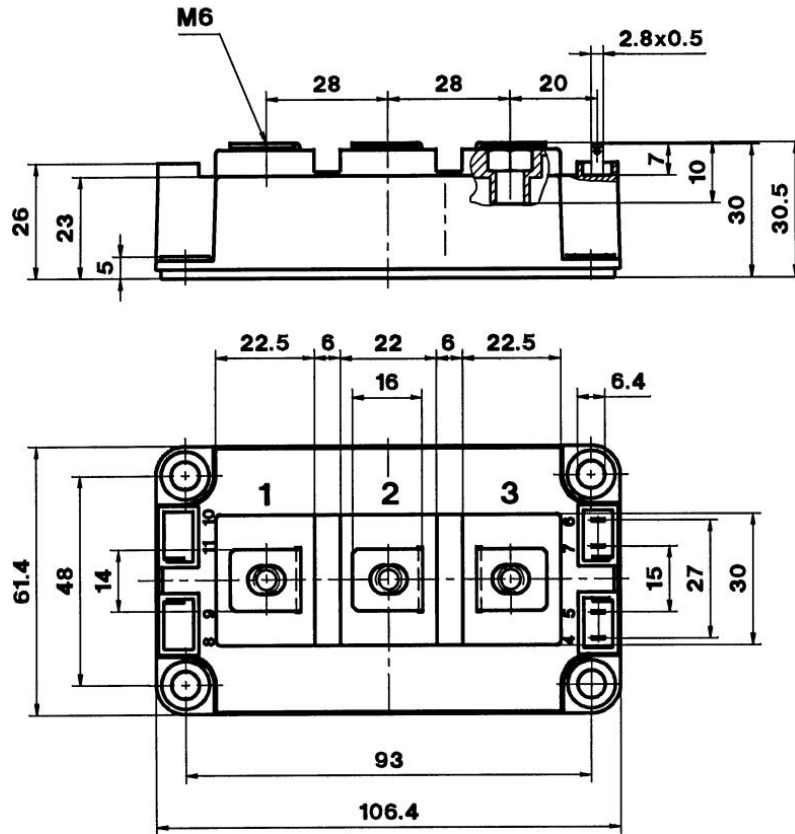

Case D 56

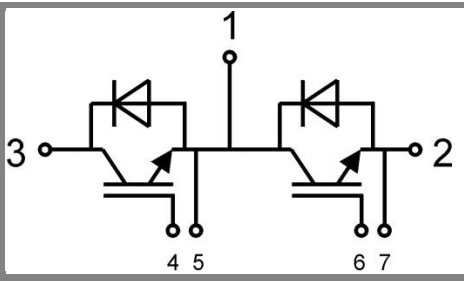

GB

Case D56

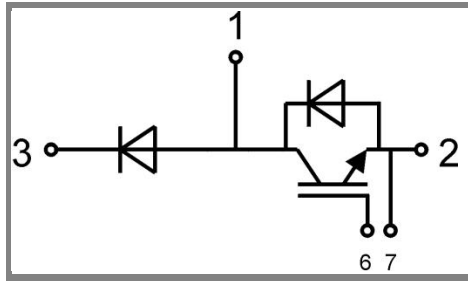

GAL

Case D57