

Buffered H-Bridge

FEATURES

- 0.65-A H-Bridge
- 200-kHz Switching Rate
- Shoot-Through Limited
- TTL Compatible Inputs
- 3.8- to 13.2-V Operating Range
- Surface Mount Packaging
- Total $r_{DS(on)}$ for N- and P-Channel:
1.8 Ω @ $V_{DD} = 4.5$ V and $T_A = 85^\circ\text{C}$

APPLICATIONS

- VCM Driver
- Brushed Motor Driver
- Stepper Motor Driver
- Power Converter
- Optical Disk Drives
- Power Supplies
- High Performance Servo

DESCRIPTION

The Si9988 is an integrated, buffered H-bridge with TTL compatible inputs and the capability of delivering a continuous 0.65 A @ $V_{DD} = 5$ V (room temperature) at switching rates up to 200 kHz. Internal logic prevents the upper and lower outputs of either half-bridge from being turned on simultaneously. Both outputs may be forced low (for motor braking) by pulling EN to logic high.

The Si9988 is available in both standard and lead (Pb)-free, 8-pin TSSOP packages, specified to operate over a voltage range of 3.8 V to 13.2 V, and the industrial temperature range of -40 to 85°C (D suffix).

FUNCTIONAL BLOCK DIAGRAM, PIN CONFIGURATION AND TRUTH TABLE

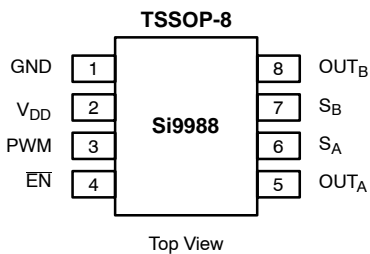

TRUTH TABLE			
EN	PWM	OUT _A	OUT _B
0	0	0	1
0	1	1	0
1	0	0	0
1	1	0	0

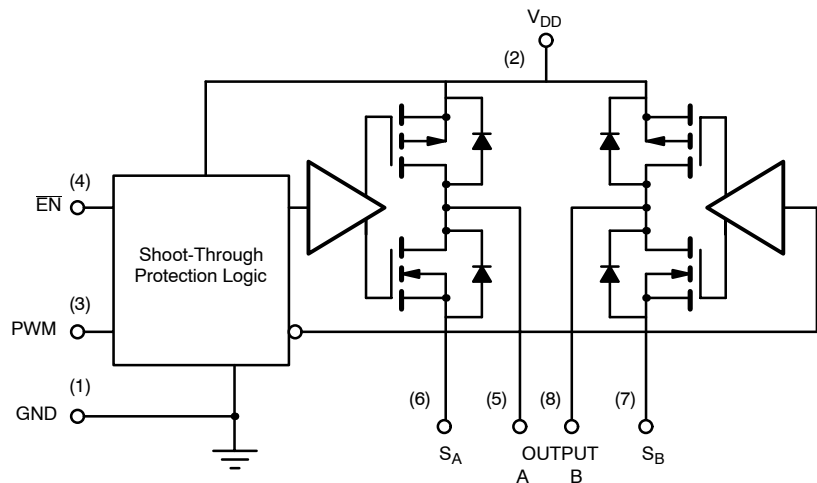

ORDERING INFORMATION			
Part Number	Marking	Temperature Range	Package
Si9988DQ-T1	988	-40 to 85°C	Tape and Reel
Si9988DQ-T1—E3			

ABSOLUTE MAXIMUM RATINGS^a

V_{DD}	15 V
Voltage on any pin with respect to ground	-0.3 V to $V_{DD} + 0.3$ V
Voltage on pins 5, 8 with respect to GND	-1 V to $V_{DD} + 1$ V
Voltage on pins 6, 7	-0.3 V to GND +1 V
Peak Output Current	1 A
Storage Temperature	-65 to 150°C
Junction Temperature (T_J)	150°C

Continuous I_{out} current ($T_J = 135^\circ\text{C}$, $V_{DD} = 5\text{V}$)

$T_A = 25^\circ\text{C}$	0.67A
$T_A = 85^\circ\text{C}$	0.47A
Power Dissipation ^b	0.83 W
θ_{JA}	120°C/W
Operating Temperature Range	-40 to 85°C

Notes

- Device mounted with all leads soldered or welded to PC board.
- Derate 8.3 mW/°C above 25°C.
- $T_J = T_A + (P_D)(\theta_{JA})$, P_D = Power Dissipation.

Stresses beyond those listed under "Absolute Maximum Ratings" may cause permanent damage to the device. These are stress ratings only, and functional operation of the device at these or any other conditions beyond those indicated in the operational sections of the specifications is not implied. Exposure to absolute maximum rating conditions for extended periods may affect device reliability.

RECOMMENDED OPERATING RANGE

V_{DD}	3.8 V to 13.2 V
Maximum Junction Temperature (T_J)	135°C

SPECIFICATIONS						
Parameter	Symbol	Test Conditions Unless Otherwise Specified $V_{DD} = 3.8$ to 13.2 V S_A @ GND, S_B @ GND	Limits D Suffix, -40 to 85°C			Unit
			Min ^a	Typ ^b	Max ^a	
Input (EN, PWM)						
Input Voltage High	V_{INH}		2			V
Input Voltage Low	V_{INL}				1	
Input Current with Input Voltage High	I_{INH}	$V_{IN} = 13.2$ V			1	μA
Input Current with Input Voltage Low	I_{INL}	$V_{IN} = 0$ V	-1			
Output						
Output Voltage High ^c	V_{OUTH}	$I_{OUT} = -300$ mA	$V_{DD} = 10.8$ V	10.55	10.70	V
			$V_{DD} = 4.5$ V	4.20	4.35	
			$V_{DD} = 3.8$ V	3.40	3.62	
Output Voltage Low ^c	V_{OUTL}	$I_{OUT} = 300$ mA	$V_{DD} = 10.8$ V		0.09	0.20
			$V_{DD} = 4.5$ V		0.12	0.25
			$V_{DD} = 3.8$ V		0.14	0.30
Output V Clamp High	V_{CLH}	$\overline{\text{EN}} = \text{PWM} \geq 2$ V	$I_{OUT} = 100$ mA		$V_{DD} + 0.7$	$V_{DD} + 1.0$
Output V Clamp Low	V_{CLL}		$I_{OUT} = -100$ mA	-1.0	-0.7	
Supply						
V_{DD} Supply Current	I_{DD}	$\overline{\text{EN}} = 0\text{V}$, PWM = 100 kHz, $V_{DD} = 5$ V		1.0	1.5	mA
		$\overline{\text{EN}} = 4.5$ V, PWM = 100 kHz, $V_{DD} = 5.5$ V		60	140	μA
		$\overline{\text{EN}} = \text{PWM} = 4.5$ V, $V_{DD} = 5.5$ V		55	110	



SPECIFICATIONS						
Parameter	Symbol	Test Conditions Unless Otherwise Specified $V_{DD} = 3.8$ to 13.2 V $S_A @ GND, S_B @ GND$	Limits D Suffix, -40 to 85°C			Unit
			Min ^a	Typ ^b	Max ^a	
Dynamic						
Propogation Delay – OUT_A^d	T_{PLH}	$V_{DD} = 5$ V, $\overline{EN} = 0$ V		300		nS
	T_{PHL}			115		
Propogation Delay – OUT_B^d	T_{PLH}			75		
	T_{PHL}			330		
Break-Before-Make ^d	BBM_{PLH}			225		
	BBM_{PHL}			215		

Notes

- a. The algebraic convention whereby the most negative value is a minimum and the most positive a maximum, is used in this data sheet.
- b. Typical values are for DESIGN AID ONLY, not guaranteed nor subject to production testing, measured $T_A = 25^\circ\text{C}$.
- c. Min and Max value mesaured at $T_J = 135^\circ\text{C}$.
- d. PLH = PWM low to high, PHL = PWM high to low.

TYPICAL CHARACTERISTICS (25°C UNLESS NOTED)

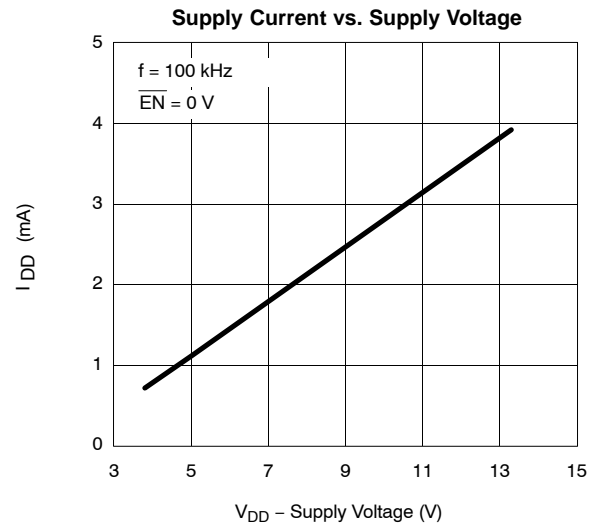
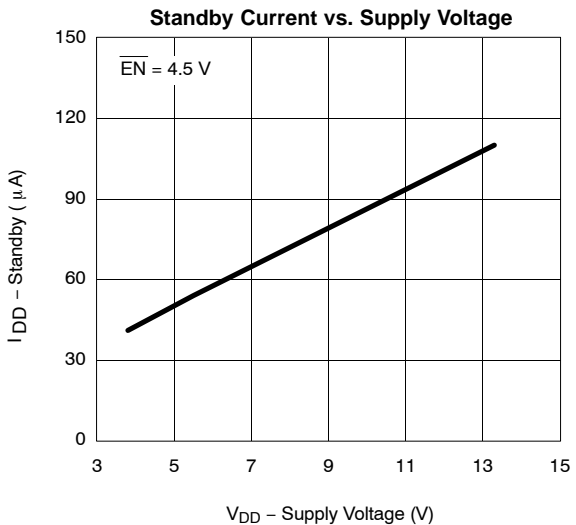
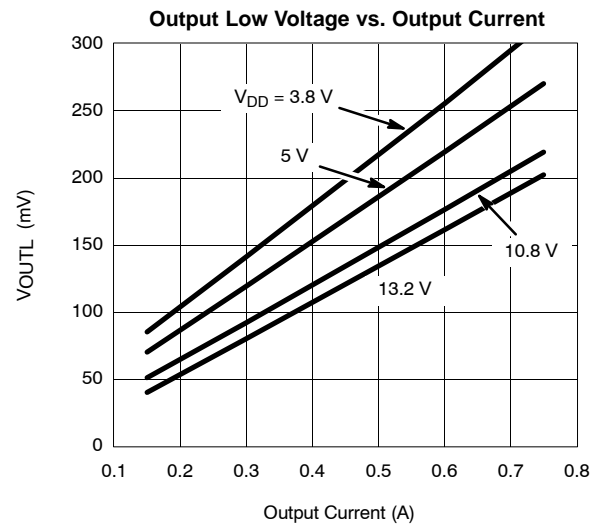
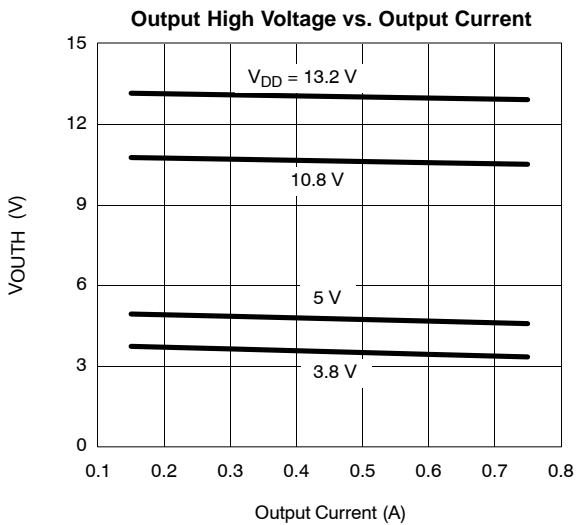

TYPICAL CHARACTERISTICS (25°C UNLESS NOTED)

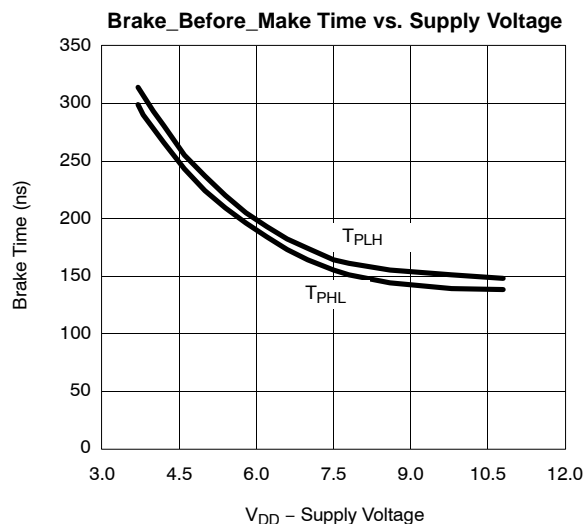
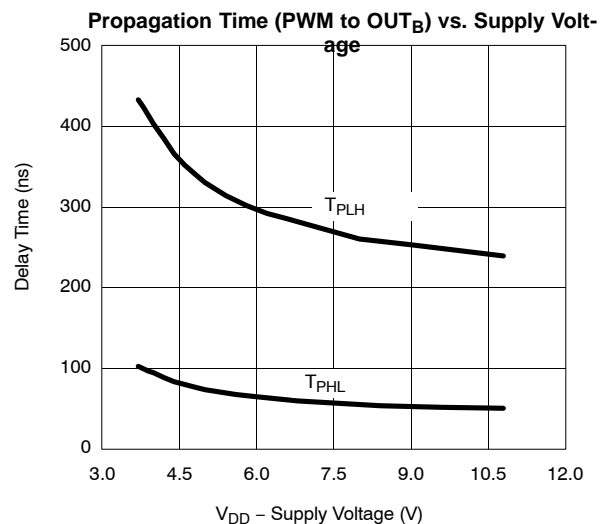
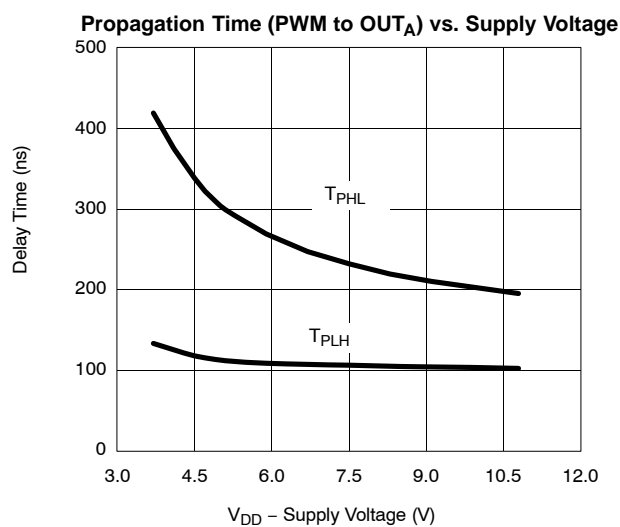
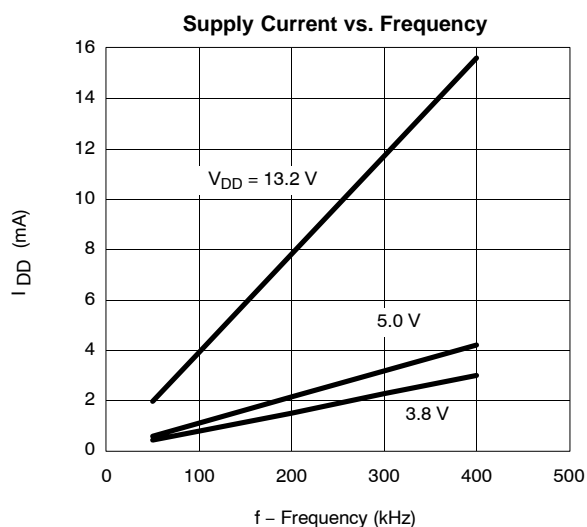
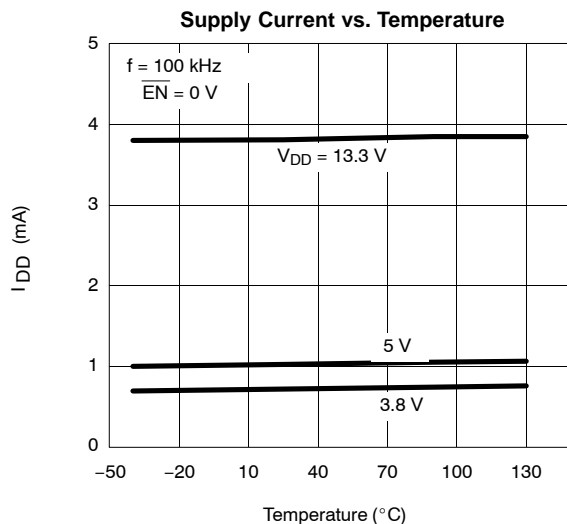
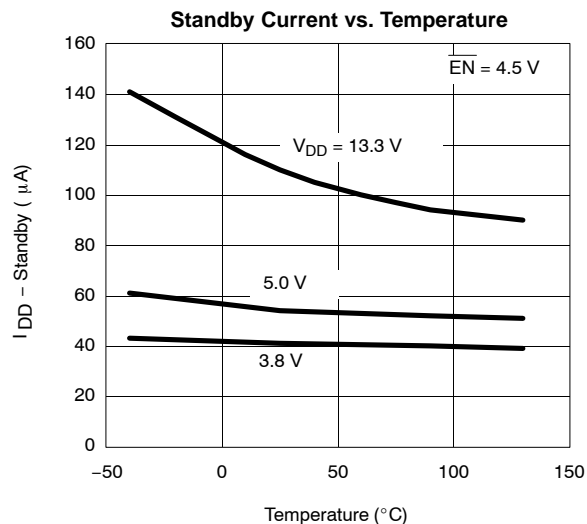

TIMING WAVEFORMS

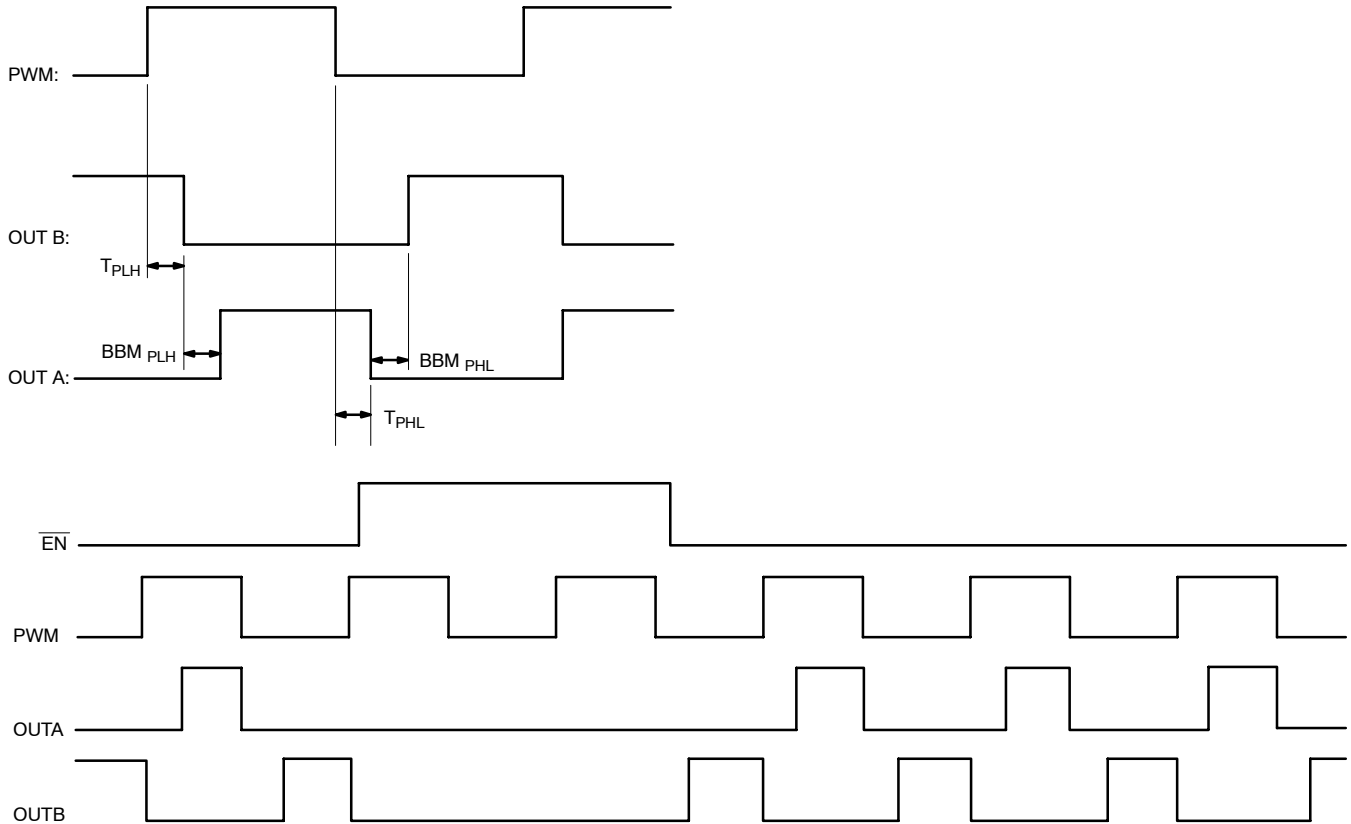

FIGURE 1.



Notice

Specifications of the products displayed herein are subject to change without notice. Vishay Intertechnology, Inc., or anyone on its behalf, assumes no responsibility or liability for any errors or inaccuracies.

Information contained herein is intended to provide a product description only. No license, express or implied, by estoppel or otherwise, to any intellectual property rights is granted by this document. Except as provided in Vishay's terms and conditions of sale for such products, Vishay assumes no liability whatsoever, and disclaims any express or implied warranty, relating to sale and/or use of Vishay products including liability or warranties relating to fitness for a particular purpose, merchantability, or infringement of any patent, copyright, or other intellectual property right.

The products shown herein are not designed for use in medical, life-saving, or life-sustaining applications. Customers using or selling these products for use in such applications do so at their own risk and agree to fully indemnify Vishay for any damages resulting from such improper use or sale.



TSSOP: 8-LEAD (POWER IC ONLY)

JEDEC Part Number: MO-153

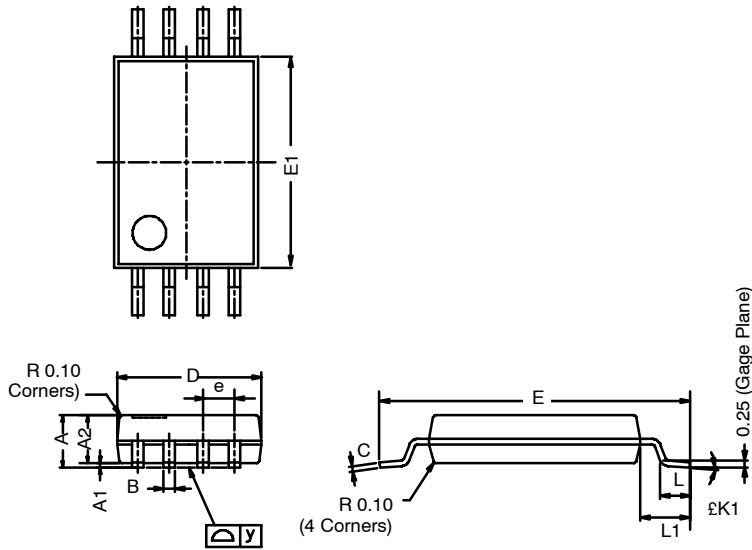

Dim	MILLIMETERS		
	Min	Nom	Max
A	-	-	1.20
A ₁	0.05	0.10	0.15
A ₂	0.80	1.00	1.05
B	0.19	0.28	0.30
C	-	0.127	-
D	2.90	3.00	3.10
E	6.20	6.40	6.60
E ₁	4.30	4.40	4.50
e	-	0.65	-
L	0.45	0.60	0.75
L ₁	0.90	1.00	1.10
Y	-	-	0.10
£K1	0°	3°	6°

ECN: S-40079—Rev. A, 02-Feb-04
DWG: 5908



Disclaimer

ALL PRODUCT, PRODUCT SPECIFICATIONS AND DATA ARE SUBJECT TO CHANGE WITHOUT NOTICE TO IMPROVE RELIABILITY, FUNCTION OR DESIGN OR OTHERWISE.

Vishay Intertechnology, Inc., its affiliates, agents, and employees, and all persons acting on its or their behalf (collectively, "Vishay"), disclaim any and all liability for any errors, inaccuracies or incompleteness contained in any datasheet or in any other disclosure relating to any product.

Vishay makes no warranty, representation or guarantee regarding the suitability of the products for any particular purpose or the continuing production of any product. To the maximum extent permitted by applicable law, Vishay disclaims (i) any and all liability arising out of the application or use of any product, (ii) any and all liability, including without limitation special, consequential or incidental damages, and (iii) any and all implied warranties, including warranties of fitness for particular purpose, non-infringement and merchantability.

Statements regarding the suitability of products for certain types of applications are based on Vishay's knowledge of typical requirements that are often placed on Vishay products in generic applications. Such statements are not binding statements about the suitability of products for a particular application. It is the customer's responsibility to validate that a particular product with the properties described in the product specification is suitable for use in a particular application. Parameters provided in datasheets and/or specifications may vary in different applications and performance may vary over time. All operating parameters, including typical parameters, must be validated for each customer application by the customer's technical experts. Product specifications do not expand or otherwise modify Vishay's terms and conditions of purchase, including but not limited to the warranty expressed therein.

Except as expressly indicated in writing, Vishay products are not designed for use in medical, life-saving, or life-sustaining applications or for any other application in which the failure of the Vishay product could result in personal injury or death. Customers using or selling Vishay products not expressly indicated for use in such applications do so at their own risk and agree to fully indemnify and hold Vishay and its distributors harmless from and against any and all claims, liabilities, expenses and damages arising or resulting in connection with such use or sale, including attorneys fees, even if such claim alleges that Vishay or its distributor was negligent regarding the design or manufacture of the part. Please contact authorized Vishay personnel to obtain written terms and conditions regarding products designed for such applications.

No license, express or implied, by estoppel or otherwise, to any intellectual property rights is granted by this document or by any conduct of Vishay. Product names and markings noted herein may be trademarks of their respective owners.