

SERIES: SDM50-UD | **DESCRIPTION:** AC-DC POWER SUPPLY

FEATURES

- up to 50 W continuous power
- meets DoE Level VI efficiency
- universal input voltage range
- compact size
- no load power consumption < 0.1 W
- over voltage and short circuit protections
- 2xMOPP compliance
- UL/cUL, TUV (60601-1) safety approvals
- LED indicator
- custom designs available



MODEL	output voltage	output current	output power	ripple and noise ¹	efficiency level
	(Vdc)	max (A)	max (W)	max (mVp-p)	
SDM50-5-UD	5	9.0	45	100	VI
SDM50-12-UD	12	4.16	50	240	VI
SDM50-15-UD	15	3.33	50	285	VI
SDM50-18-UD	18	3.15	57	270	VI
SDM50-24-UD	24	2.08	50	360	VI
SDM50-48-UD	48	1.04	50	720	VI

Notes: 1. At full load, nominal input, 20 MHz bandwidth oscilloscope, output terminated with 0.1 µF multilayer ceramic and 47 µF low ESR electrolytic capacitors.

PART NUMBER KEY

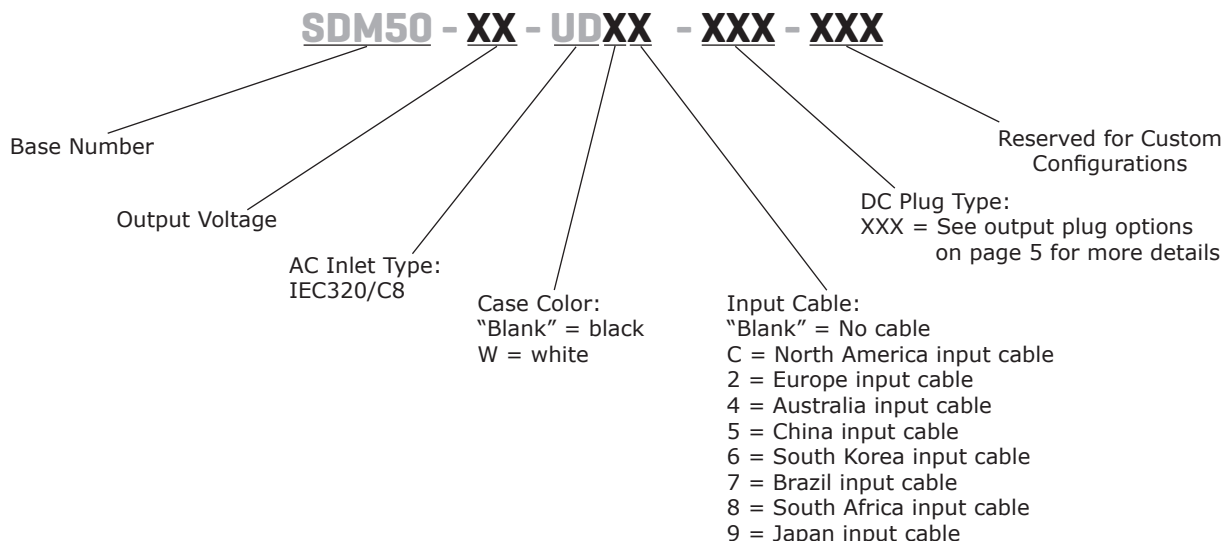

INPUT

parameter	conditions/description	min	typ	max	units
voltage		90		264	Vac
frequency		47		63	Hz
current	at 100 Vac, full load			2.0	A
inrush current	at 230 Vac, full load, cold start			160	A
leakage current	at 240 Vac/50 Hz			0.1	mA
no load power consumption	at 115 Vac/60 Hz ~ 230 Vac/50 Hz 5 Vdc output model all other output models			0.1 0.21	W W

OUTPUT

parameter	conditions/description	min	typ	max	units
load regulation			±5		%
line regulation	at full load		±1		%
start-up time				3	s
rise time	at full load, 10~90% output voltage			50	ms
hold-up time	at full load	8.3			ms

PROTECTIONS

parameter	conditions/description	min	typ	max	units
over voltage protection	5 Vdc output model, output shut-down with latch			180	%
	12 Vdc output model, output shut-down			150	%
	15 Vdc output model, output shut-down with latch			150	%
	18 Vdc output model, output shut-down			170	%
	24 Vdc output model, output shut-down with latch			175	%
over current protection	continuous, auto recovery	110		200	%
short circuit protection	continuous, auto recovery				

SAFETY & COMPLIANCE

parameter	conditions/description	min	typ	max	units
isolation voltage	15 Vdc output model input to output at 5 mA for 2 seconds		1,800		Vac
	all other output models input to output at 5 mA for 2 seconds		4,000		Vac
safety approvals	60601: UL/cUL, TUV				
EMI/EMC	EN 55011 FCC Part 15 Class B				
MTBF	as per MIL-HDBK-217F, 25°C	100,000			hours
RoHS	yes				

ENVIRONMENTAL

parameter	conditions/description	min	typ	max	units
operating temperature		0		40	°C
storage temperature		-20		85	°C
operating humidity	non-condensing	10		90	%
storage humidity	non-condensing	5		90	%

MECHANICAL

parameter	conditions/description	min	typ	max	units
dimensions	113 (L) x 49 (W) x 35 (H)				mm
inlet plug	IEC320/C8				
weight	5, 12, 24, 48 Vdc output models		300		g
	15 Vdc output model		260		g
	18 Vdc output model		270		g

MECHANICAL DRAWING

units: mm
tolerance: ±1.0 mm

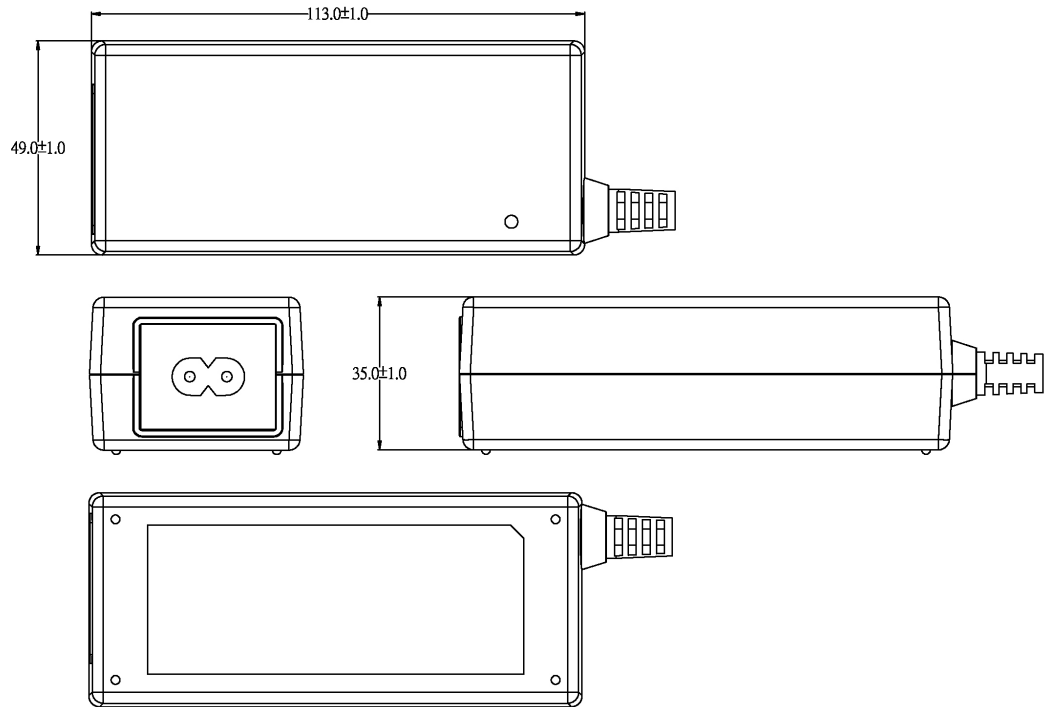

DC CORD

units: mm

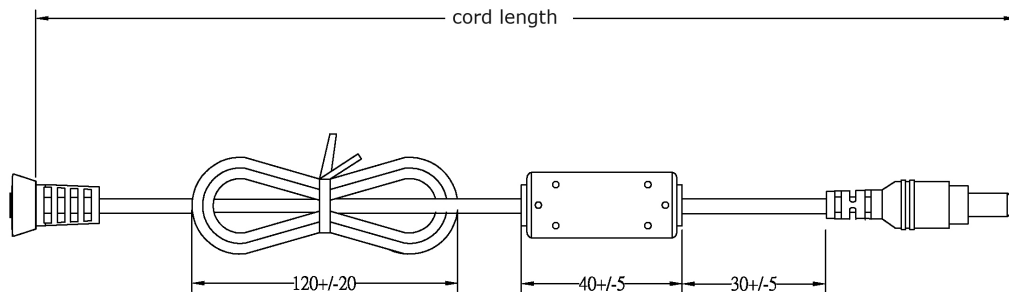
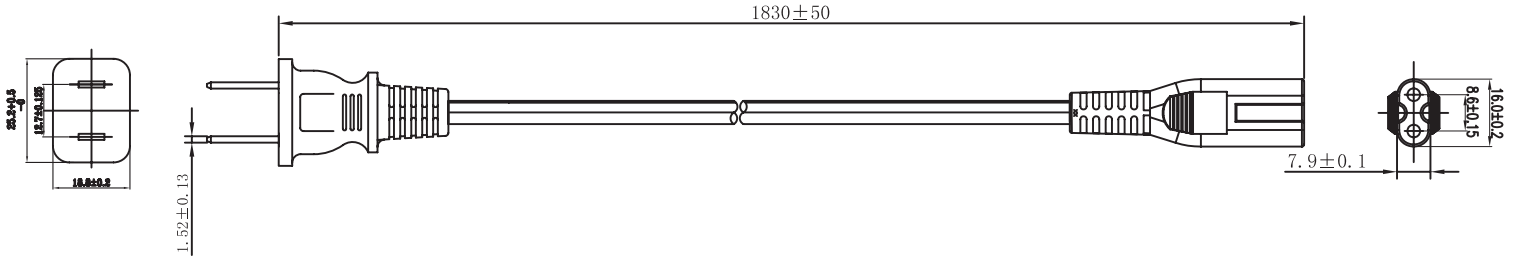

Table 1

MODEL NO.	CABLE	CORD LENGTH
SDM50-5-UD	UL1185, 14 AWG	1,200 mm ±30
SDM50-12-UD	UL1185, 16 AWG	1,200 mm ±30
SDM50-15-UD	UL1185, 16 AWG	1,200 mm ±30
SDM50-18-UD	UL1185, 18 AWG	1,200 mm ±30
SDM50-24-UD	UL1185, 18 AWG	1,200 mm ±30
SDM50-48-UD	UL1185, 18 AWG	1,200 mm ±30

AC CORDS

units: mm



NORTH AMERICA

EUROPE

AUSTRALIA

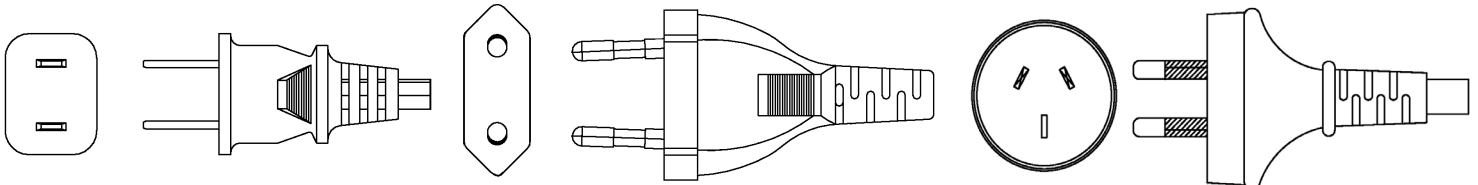

CHINA

KOREA

BRAZIL

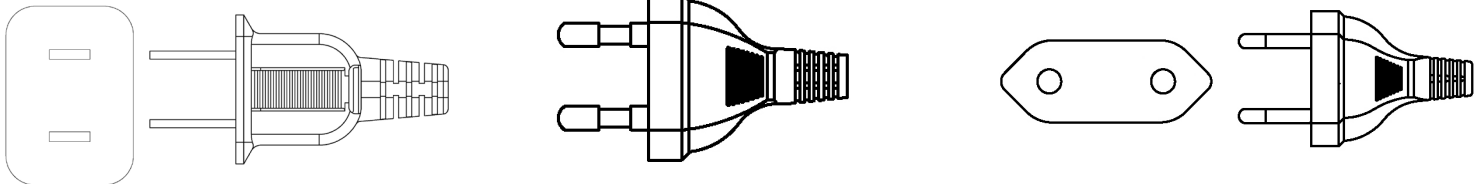

SOUTH AFRICA

JAPAN

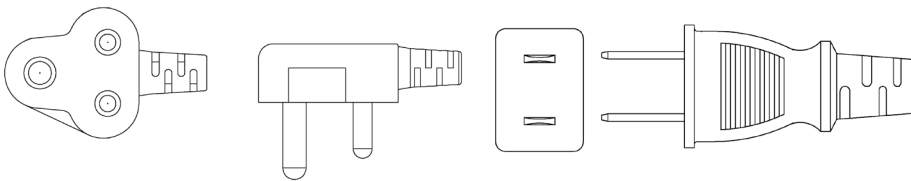



Table 2

AC Input	Cord Length
North America	1,830 mm ±50
Europe	1,830 mm ±50
Australia	1,830 mm ±50
China	1,830 mm ±50
South Korea	1,830 mm ±50
Brazil	1,800 mm ±50
South Africa	1,800 mm ±50
Japan	1,800 mm ±50

DC PLUG TYPE PART NUMBER KEY

XXX

Plug Polarity:
 P = Center Positive

 N = Center Negative

Plug Code:
 X = Choose a code from the options below

Plug Angle:
 "blank" = Straight
 R = Right Angle

Plug Polarity		Code		Dimensions (mm)			Plug Angle	
Center Pos.	Center Neg.	Option	Type	A	B	C	Straight	Right
•	•	5	Standard	5.5	2.1	9.5	•	•
•	•	6	Standard	5.5	2.5	9.5	•	•
•	•	7	Standard	3.5	1.35	9.5	•	•
•	•	8	Standard	3.8	1.35	9.5	•	•
•	•	9	Standard	3.8	1.05	9.5	•	•
N/A	N/A	ST	Stripped & Tinned			N/A	N/A	

Note: 1. Contact CUI for additional plug options

Standard

Stripped & Tinned

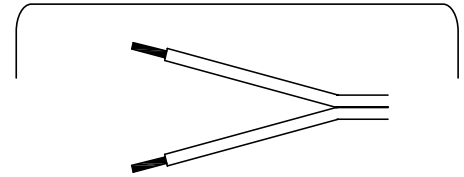
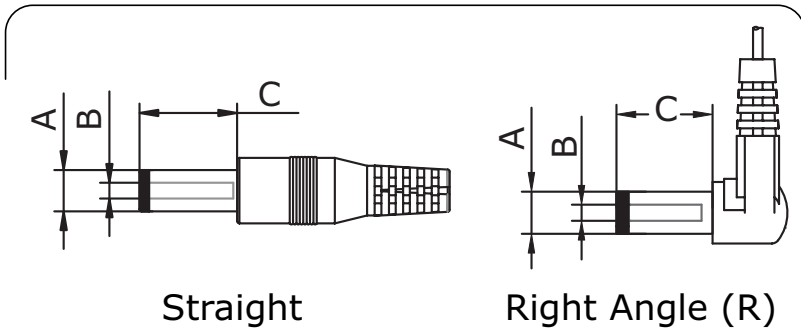

REVISION HISTORY

rev.	description	date
1.0	initial release	05/31/2021
1.01	PSE and UKCA removed from safeties	08/27/2021

The revision history provided is for informational purposes only and is believed to be accurate.



Headquarters
20050 SW 112th Ave.
Tualatin, OR 97062
800.275.4899

Fax 503.612.2383
cui.com
techsupport@cui.com

This device complies with part 15 of the FCC Rules. Operation is subject to the following two conditions:

- (1) This device may not cause harmful interference, and
- (2) this device must accept any interference received, including interference that may cause undesired operation.

CUI offers a one (1) year limited warranty. Complete warranty information is listed on our website.

CUI reserves the right to make changes to the product at any time without notice. Information provided by CUI is believed to be accurate and reliable. However, no responsibility is assumed by CUI for its use, nor for any infringements of patents or other rights of third parties which may result from its use.

CUI products are not authorized or warranted for use as critical components in equipment that requires an extremely high level of reliability. A critical component is any component of a life support device or system whose failure to perform can be reasonably expected to cause the failure of the life support device or system, or to affect its safety or effectiveness.