

SC-15-10JH

Aliases (UALSC1510JH000)

KEMET, SC-JH, AC Line Filters, Common Mode, 1mH

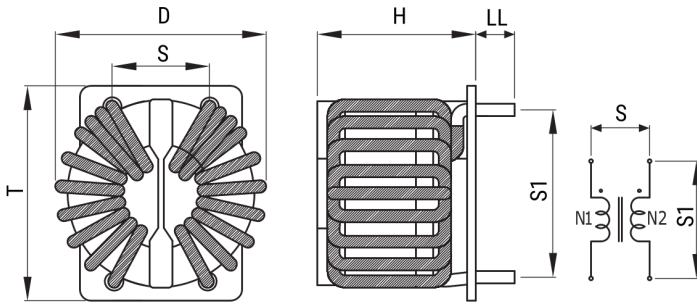

Click [here](#) for the 3D model.

Dimensions

D	44mm MAX
T	41mm MAX
H	32mm MAX
LL	5mm +/-2mm
S	17mm NOM
S1	30mm NOM
Wire Size	1.7mm

Packaging Specifications

Packaging	Tray
Packaging Quantity	100
Typical Component Weight	73 g

General Information

Series	SC-JH
Style	Through-Hole
RoHS	Yes
Notes	Lead Spacing (S/S1) Are For Reference Only.
Miscellaneous	Temperature Rise Maximum: 50 K.
Core	Mn-Zn Ferrite

Specifications

Voltage AC	250 VAC
Inductance	1 mH (100 kHz)
Current	15 A
Temperature Range	-40/+105°C
DC Resistance	12 mOhms