

KEMET Part Number: SBT-0260T
(UDLSBT00260T00)

KEMET
a YAGEO company

KEMET, SBT, DC Line Filters, Normal Mode, 60 uH, 35%

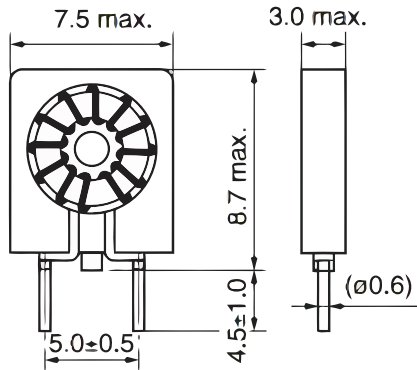

Dimensions

Dimension	Value
L	7.5mm MAX
W	3mm MAX
T	3mm MAX
H	8.7mm MAX
LL	4.5mm +/-1mm
S	5mm +/-0.5mm

Packaging Specifications

Packaging:	T&R
Packaging Quantity:	2000
Component Weight:	260 mg

General Information

Series:	SBT
Style:	Through-Hole
RoHS:	Yes
Miscellaneous:	Inductance: 70mAmps (1kHz)

Specifications

Voltage DC:	50 VDC
Inductance:	60 uH
Inductance Tolerance:	35%
Temperature Range:	-25/+70°C
DC Resistance:	50 mOhms

Statements of suitability for certain applications are based on our knowledge of typical operating conditions for such applications, but are not intended to constitute - and we specifically disclaim - any warranty concerning suitability for a specific customer application or use. This Information is intended for use only by customers who have the requisite experience and capability to determine the correct products for their application. Any technical advice inferred from this Information or otherwise provided by us with reference to the use of our products is given gratis, and we assume no obligation or liability for the advice given or results obtained.

KEMET
a YAGEO company