



**MAIDA STYLE NUMBER** S6678ZOV581RA720

**MAIDA ITEM NUMBER** 01-1387

The Low Profile Series compliments our Standard Series as our square, radial-leaded varistors. These components consist of wire leads and have nominal sizes from 12mm to 25mm. They are available with maximum continuous operating voltages (MCOV) ranging from 130VAC to 1000VAC.

The Low Profile Series are designed to fit into spaces that Standard Series electrically equivalent are unable to fit. Most sizes are available in Tape and Reel and ammo pack.

The Maida Style Number is the typical means to identify our components when ordered. The style number identifies several parameters that are important for the characteristics of the device. An alternative ordering method, if known, is by our Item Number.

The following example is the standard part numbering system when ordering our Standard Series components by the Maida Style Number:

**R 65 21 ZOV 131 RA 20 T1N**

**Coating Designation**

R – Standard Epoxy Coating  
 S – Standard Epoxy Coating - (25mm)  
 PR/PS - Phenolic Coating  
 None – Denote no conformal coating.

**Nominal Sizes**

R69 - 12mm Square  
 R65 - 17mm Square  
 R66 - 22mm Square  
 S66 - 25mm Square

**Lead Configuration**

**Material Identifier**

Zinc Oxide Varistor

**AC Voltage Rating**

Two significant figures plus number of zeroes that follow, i.e. 131 is 130VAC

**Special Instructions**

RA is standard

**Rating Code**

Up to four numbers

**Optional Taping Code**

T - Tape and Reel or Tape and Ammo

Followed by two digit alphanumeric

**Electrical Specifications**

Continuous AC Voltage	580 VAC
Continuous DC Voltage	735 VDC
Maximum DC Leakage @ 735 VDC	200 uA
Low Varistor Voltage Limit	821 VDC
High Varistor Voltage Limit	1002 VDC
Nominal Varistor Voltage	912 VDC
Current for Varistor Voltage	1 mA
Maximum Clamp Voltage	1430 V
Maximum Clamp Voltage Test Current	200 A
Peak Current Rating (1 Pulse)	15000 A
Peak Current Rating (2 Pulse)	12000 A
Energy Rating (8X20us)	970 J
Typical Capacitance	990 pF
Impulse Response Time	< 50 ns
Minimum Hipot of Coating	2500 VDC
Minimum I.R. of Coating	1000 MΩ
Current/Energy Derating Above 85°C	-2.5 %/°C

**Special Notes:**

**Safety Agency Recognitions**

UL 1449 File Number	E321173
- Tested to Type:	5-5kA
C-UL File Number	E321173
VDE File Number	
CSA File Number	
SEV File Number	

**MAIDA DEVELOPMENT COMPANY**

P.O. Box 3529

Hampton, Virginia 23663

Ph: (757) 723-0785 Fax (757) 722-1194

[www.maida.com](http://www.maida.com)

## Characteristic Graphs

### S66 (25mm SQUARE) SERIES

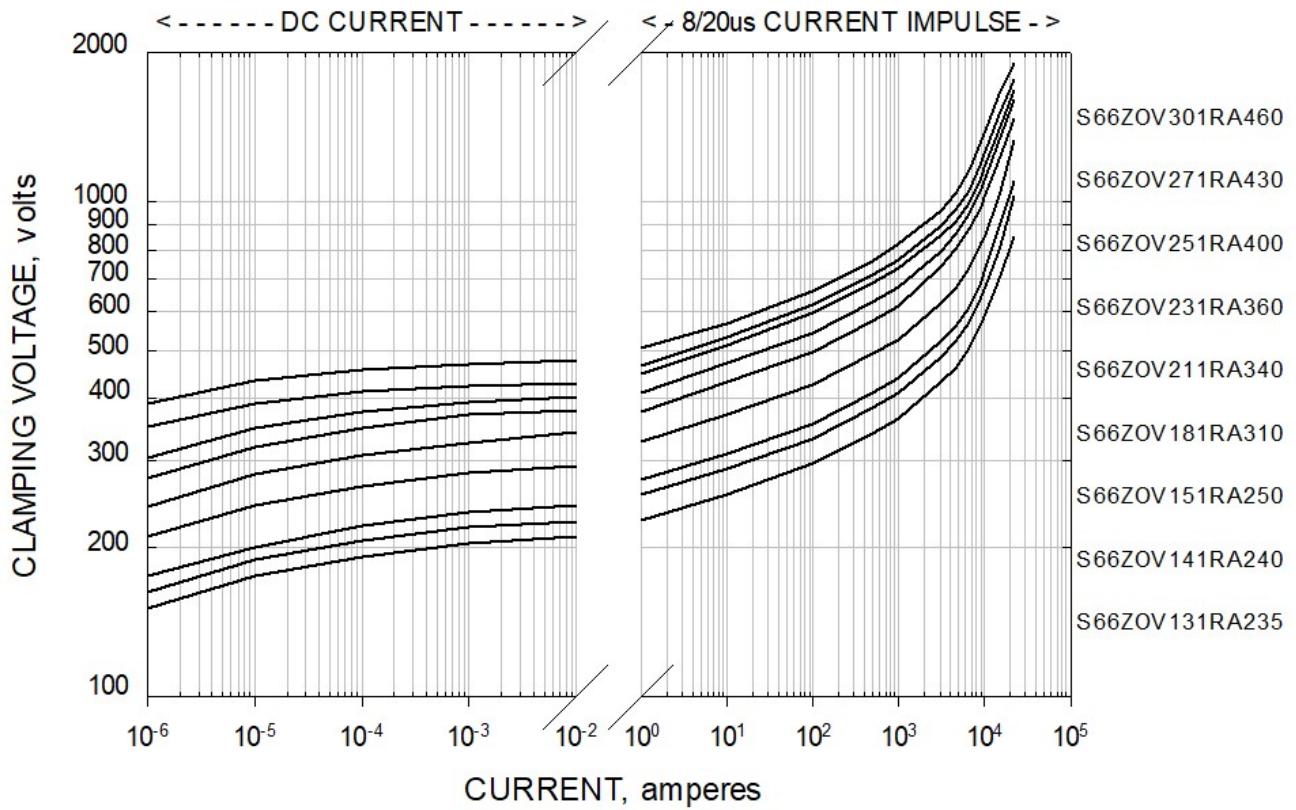

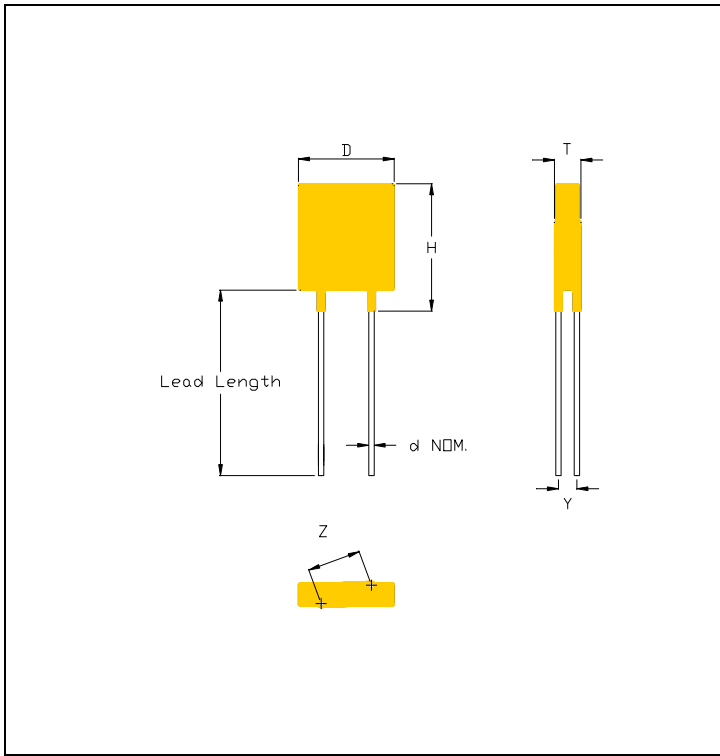

### Physical Specifications

Lead Style	059L1
X Nominal	0.394 in.
X Tolerance	0.04 in.
Y Nominal	0.257 in.
Y Tolerance	0.03 in.
Z Nominal	0.47 in.
Z Tolerance	0.04 in.
Lead Length Nominal	1.00 in.
Lead Length Tolerance	min. in.
d Nominal	0.032 in.
Wire Gauge	20 AWG
Minimum Marking	S66-581UL
Nominal Disk Size	25 mm
D Maximum	1.142 in.
T Maximum	0.382 in.
H Maximum	1.267 in.
Coating Type	EPOXY

### Thermal Specifications

Minimum Operating Temperature	-40 °C
Maximum Operating Temperature	85 °C
Varistor Voltage Temperature Coeff	-0.05 %/°C
Minimum Storage Temperature	-50 °C
Maximum Storage Temperature	125 °C
Recommended Solder Temperature	260 °C
Recommended Reflow Temperature	260 °C

### Environmental Compliances



### Recommended Soldering Profile

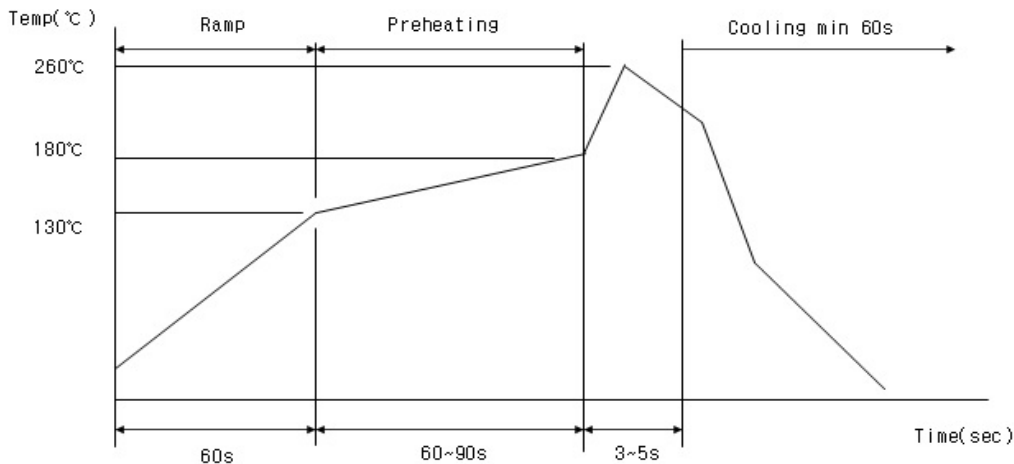

## MOV Terminology

TECHNICAL TERM	DESCRIPTION
Operating Temperature	Operating Temperature Range without Derating.
Storage Temperature	Storage Temperature Range without Voltage Applied.
Curent / Energy Derating	Derating of maximum Values when Operated above +85°C
Varistor Voltage Temperature Coefficient	$\frac{V_v \text{ at } 85^\circ\text{C} - V_v \text{ at } 25^\circ\text{C}}{V_v \text{ at } 25^\circ\text{C}} \times \frac{1}{60} \times 100$ <p>Where Vv is varistor voltage at 1mADC</p>
Insulation Resistance	Minimum resistance between shorted terminals and varistor surface.
HiPot Encapsulation	Minimum voltage applied for one minute between shorted terminals and varistor surface.
Impulse Response Time	Time lag between application of surge and varistor's "turn-on" conduction state.
DC Leakage Current	Maximum current with specified DC voltage applied.
Applied Voltage - AC	Maximum continuous sinusoidal RMS voltage which may be applied (MCOV).
Applied Voltage - DC	Maximum continuous DC voltage which may be applied.
Transient Energy (Joules)	The maximum energy absorbed with a varistor voltage change of less than $\pm 10\%$ when one impulse of an 8x20us current waveform is applied.
Transient Peak Current	The maximum current with a varistor voltage change of less than $\pm 10\%$ when one impulse of an 8x20us current waveform is applied.
Varistor Voltage	Voltage across the varistor measured at 1mADC
Maximum Clamping Voltage	Peak voltage across the varistor with a specific peak impulse current applied (8x20us).
Capacitance	Typical value measured at 1Vrms and a test frequency of 1KHz.