

RRC-MC20-90-10

Battery Mating Connector

P/N: 210519

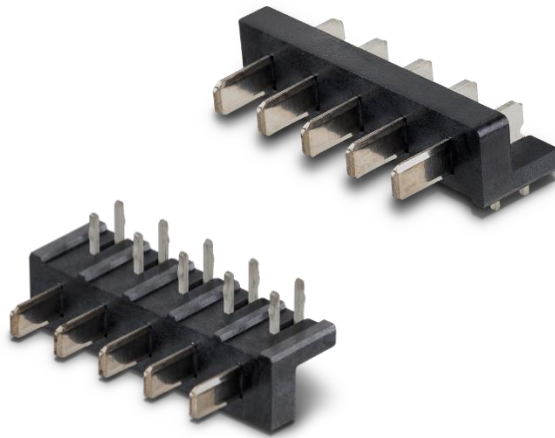

Features:

- Mating connector for standard battery from factors RRC20xx
- 10.00A max. charge or discharge current to battery
- 5-pin male connector
- 5mm pitch
- RoHS and REACH compliant

Applications:

Mating connector for RRC's smart batteries used in medical, industrial and consumer applications

Specification

Ratings	
Current	10.00A max. / pin
Voltage	125.00VAC / 1min
Materials	
Housing	Thermoplastic High Temperature, UL 94V-0, black
Contacts	Copper Alloy
Plating	80µm Nickel on contact area, 100µm Matte-Tin on solder tails
Environmental Condition	
Operating Temperature	-55°C to +105°C
Electrical Requirements	
Contact Resistance	30mOhm max.
Insulation Resistance	100MOhm min. at 500VDC / 2min
Dielectric withstand	500.00V
Mechanical Requirements	
Dimensions (LxWxH)	27mm x 13.70mm x 9.90mm
Weight	Typical 3g
PCB mounting	90°
Contact Retention Force	500g min. / pin
Durability	5000 cycles
Physical Requirements	
Solder Temperature	245°C ± 5°C
Immersion Period	3 ± 0.5sec
Regulatory Approvals	
Green Procurement	RoHS REACH
Packaging	
22 connectors per tube	
77 tubes per carton	

Drawings

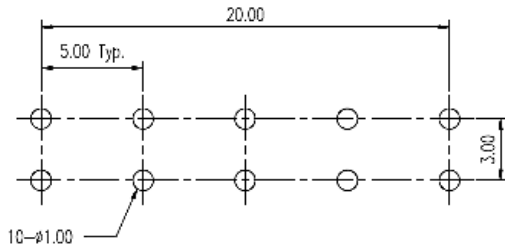
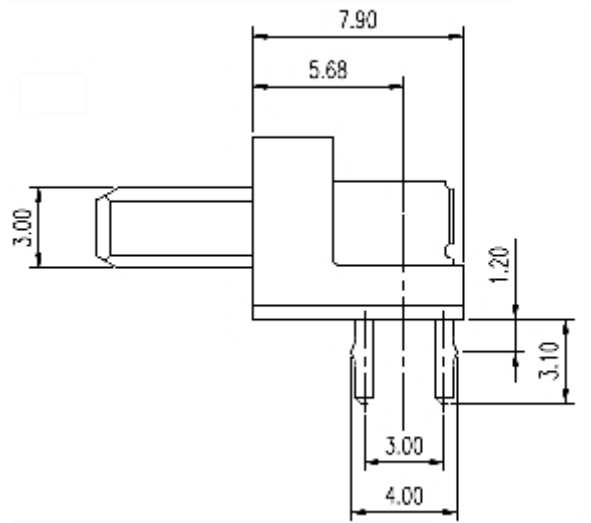
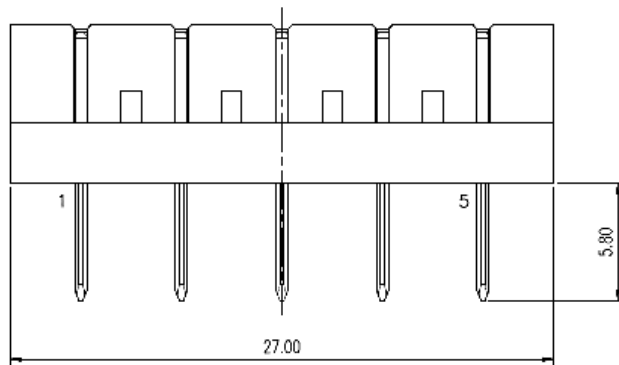
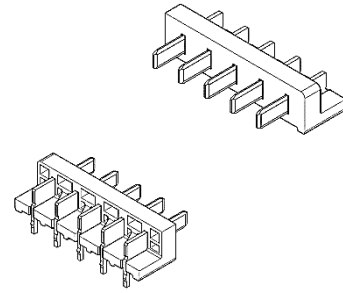
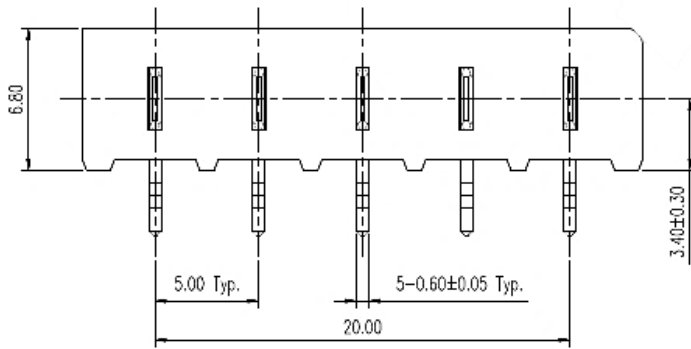

Germany/Headquarters

RRC power solutions GmbH
Technologiepark 1
66424 Homburg / Saar

Tel.: +49 6841 98090
Fax: +49 6841 9809280
Email: sales@rrc-ps.de
Web: www.rrc-ps.de

USA

RRC power solutions Inc.
18340 Yorba Linda Blvd.,
107-437 Yorba Linda,
CA 92886-4104

Tel.: +1 714 777 3604
Fax: +1 714 777 3658
Email: usa@rrc-ps.com
Web: www.rrc-ps.com

Hong Kong

RRC power solutions Ltd.
S-V,6/F, Valiant Industrial
Centre 2-12 Au Pui Wan Street
Fo Tan, N.T., Hong Kong

Tel.: +852 2376 0106
Fax: +852 2375 0107
Email: hkrrc@rrc-ps.cn
Web: www.rrc-ps.com

China

RRC power solutions Ltd.
Room 1306, C Building,
Tianan International building,
Renmin South Road, Luohu
District, Shenzhen 518021

Tel.: +86 755 8374 1908
Fax: +86 755 8374 1861
Email: hkrrc@rrc-ps.cn
Web: www.rrc-ps.com