

Title AlGaAs, double-heterojunction, visible laser diodes

RLD-78PP-G1 / RLD-78NP-G1

RLD-78PP-G1 and RLD-78NP-G1 are the semiconductor laser developed for the laser beam printer application. We have achieved the very small variations of the optical characteristics and low droop by ROHM original Epitaxial growth technology using Molecular Beam Epitaxy. In addition, they have the appropriate characteristics for sensor application as well.

●Applications

Laser beam printers
Sensors

●Features

- 1) Minimum variation of radiation beam angle.
- 2) Low droop.
- 3) High stability wave length.
- 4) Can be driven by single power supply.

●External dimensions (Units : mm)

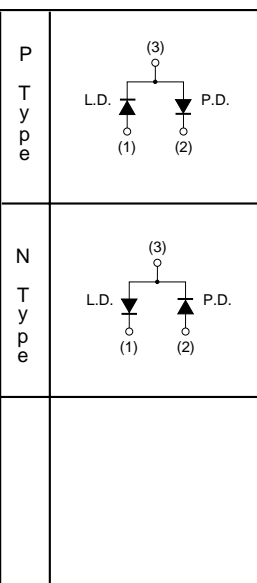
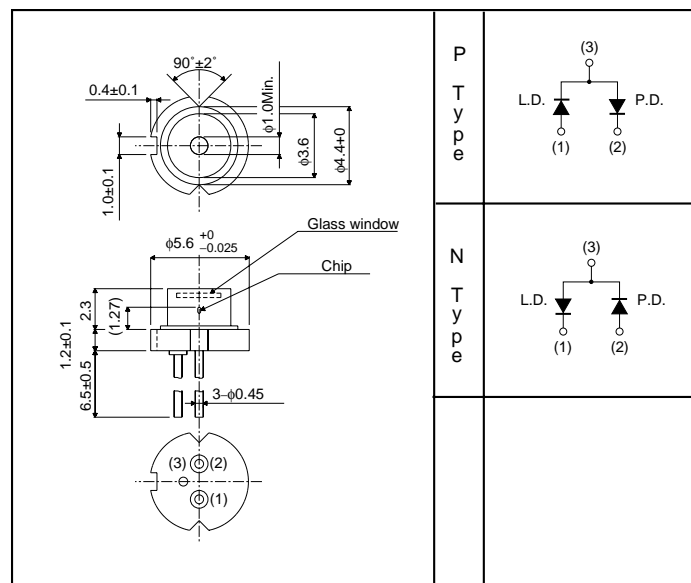

●Absolute maximum ratings (Tc=25°C)

Parameter	Symbol	Limits	Unit	
Output	Po	5	mW	
Reverse voltage	Laser	V _R	2	V
	PIN photodiode	V _{R(PIN)}	30	V
Operating temperature	Topr	-10~+60	°C	
Storage temperature	Tstg	-40~+85	°C	

Laser Diodes

●Electrical and optical characteristics (Ta=25°C)

Parameter	Symbol	Min.	Typ.	Max.	Unit	Conditions
Threshold current	I_{th}	10	25	45	mA	-
Operating current	I_{op}	15	45	65	mA	Po=3mW
Operating voltage	V_{op}	-	1.9	2.3	V	Po=3mW
Differential efficiency	η	0.1	0.2	0.3	mW/mA	$\frac{2mW}{I(3mW)-I(1mW)}$
Monitor current	I_m	0.3	0.55	0.9	mA	Po=3mW
Parallel divergence angle	$\theta_{//}^*$	8	11	15	deg	Po=3mW
Perpendicular divergence angle	θ_{\perp}^*	25	30	38	deg	
Parallel deviation angle	$\Delta\phi_{//}$	-	-	± 2	deg	
Perpendicular deviation angle	$\Delta\phi_{\perp}$	-	-	± 3	deg	
Emission point accuracy	ΔX ΔY ΔZ	-	-	± 80	μm	-
Peak emission wavelength	λ	770	785	795	nm	Po=3mW
Drop	ΔP	-	5	10	%	Po=3mW

* $\theta_{//}$ and θ_{\perp} are defined as the angle within which the intensity is 50% of the peak value.

●Electrical and optical curves

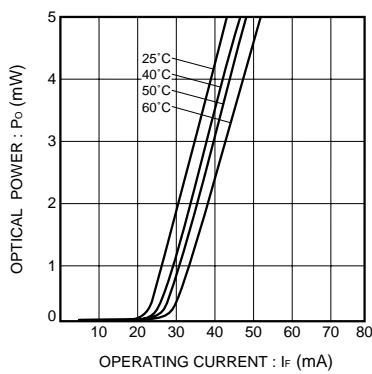

Fig. 1 Optical output vs. operating current

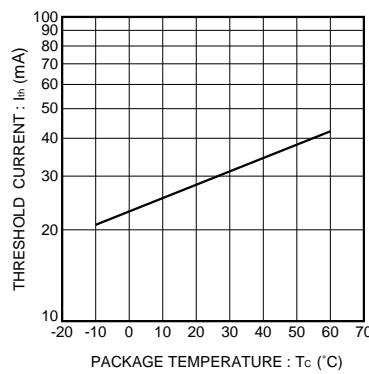

Fig. 2 Dependence of threshold current on temperature

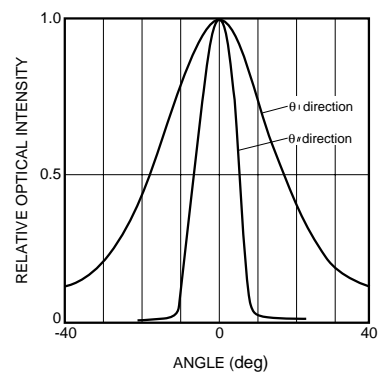

Fig. 3 Far field pattern

Laser Diodes

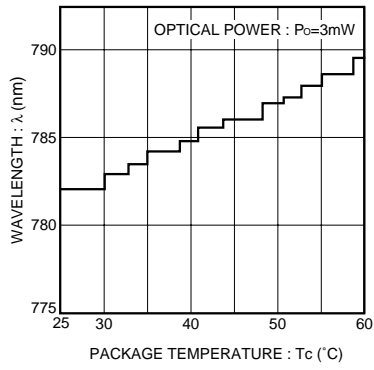

Fig. 4 Dependence of wavelength on temperature

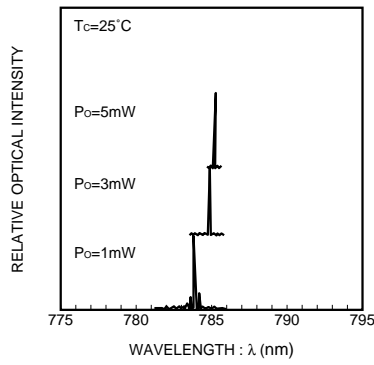

Fig. 5 Dependence of emission spectrum on optical output

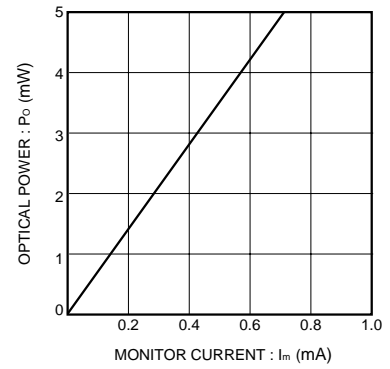

Fig. 6 Monitor current vs. optical output

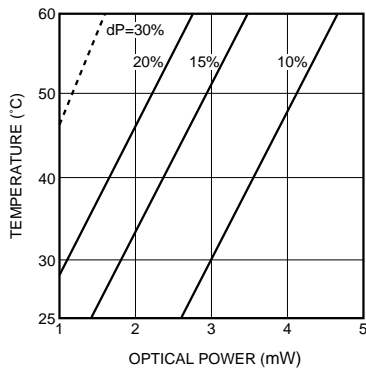

Fig. 7 Temperature vs. output guidelines for various droop percentages

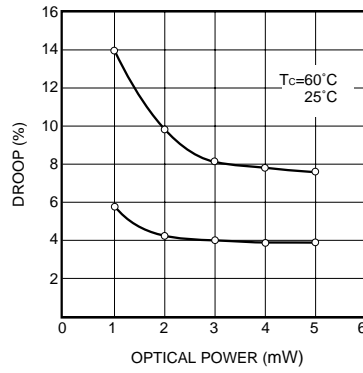

Fig. 8 Dependence of droop on output

This datasheet has been downloaded from:

www.DatasheetCatalog.com

Datasheets for electronic components.